

Blackouts during navigation in narrow passages

Tuomas Roos

Jerry Virkkunen

Degree Thesis for Bachelor of Marine Technology

Degree Programme of Maritime Management

Turku 2016



BACHELOR'S THESIS

Author: Tuomas Roos, Jerry Virkkunen

Degree Program: Degree Program in Maritime Studies, Turku

Specialization: Bachelor of Marine Technology

Supervisor: Bo Lindroos

Title: Blackouts during navigation in narrow passages

Date 30.3.2016

Number of pages 45

Appendices 7

Summary

This thesis gives you the basic knowledge about the characteristics of blackouts. You will also learn how to react as an officer in a blackout situation.

The thesis consists of two parts: theory and research. The theory part will give you details on what a blackout is, details on ship electricity and emergency power sources and above all, things to consider as an officer in a blackout situation. The theory part also includes law text in an easy to understand form.

The latter part is a description of a simulator based study. 15 students completed exactly the same simulator exercise where they experienced a blackout onboard their ship. The students formed eight bridge teams which were divided into two groups. Half of the students were given a blackout checklist and the other half had to manage without it.

The goal for the research was to measure the importance of a checklist in a blackout situation. We were able to conclude that the checklist did not save the vessel from grounding but it appeared to help when performing minor tasks involved in bridge procedures during a blackout.

Language: English

Key words: blackout, ship electricity, bridge routines, simulator research

The examination work is available at the electronic library Theseus.fi

Table of contents

1	Introduction	1
1.1	Objective	1
1.2	Problem formulation.....	1
1.3	Delimitation.....	1
2	What is blackout?	2
2.1	Level one.....	2
2.2	Level two.....	2
2.3	Level three	2
3	Electricity onboard	3
3.1	Electricity consumers	3
3.2	Electricity production onboard.....	3
3.3	Providing electricity in emergency situations	4
3.3.1	Emergency generator.....	6
3.3.2	Uninterruptable Power Source	6
3.3.3	GMDSS-batteries	7
4	Reaction in case of a blackout	8
4.1	Checklist.....	8
4.2	Actions to be taken on bridge.....	8
4.3	Actions to be taken in the engine room.....	11
4.3.1	Emergency steering.....	11
4.4	Possible outcome of a blackout.....	12
4.5	How to recover from a blackout.....	13
5	Reasons for blackout.....	13
5.1	How to prevent blackout situations.....	13
5.2	Other causes for loss of control on bridge.....	14
6	Land based organizations	14
7	Improvements for ships.....	17
8	Blackout onboard M/S Amorella.....	18
9	Simulator research.....	19
9.1	Objective	19
9.2	Description.....	19
9.3	Participants' background	21
9.4	Ship details.....	22
9.5	Bridge equipment.....	23
9.6	The exercise.....	24

9.7	Actions of the teams	26
9.7.1	Items on the datasheet and collected data	27
9.8	Exercise outcomes	31
9.8.1	Team specific outcomes	31
9.9	Questionnaire	40
9.10	Conclusion.....	41
9.11	Project evaluation	42
10	Final words.....	43
	References	44
	Figures.....	45
	Appendices	

List of terms

Shaft generator = Generator type which gets its power from the main propulsion plant

UPS = Uninterruptible Power Supply

OOW = Officer Of the Watch

SOLAS = Safety Of Life At Sea

VTS = Vessel Traffic Service. VTS monitors all vessels within its area, organizes traffic, provides navigational assistance if necessary, informs vessels about relevant weather and traffic information and provides knowledge about the state of the fairways and the navigational safety equipment. All vessels must monitor VTS-traffic channels while being within the VTS-area.

MRCC = Maritime Rescue Coordination Centre

GMDSS = Global Maritime Distress and Safety System

GT = Gross Tonnage, is a unitless index related to a ship's overall internal volume

Classification Society = A non-governmental organization that establishes and maintains technical standards for the construction and operation of ships

RPM = Rounds Per Minute

KaMeWa = brand name of the controllable-pitch propellers manufacturer (AB Karlstad Mekaniska Werkstads)

Override tiller = Emergency steering method that overrides all other steering methods

COC = Certificate Of Competence

IMO = International Maritime Organization

ISM Code = International Safety Management Code

SAR = Search and Rescue

MOB = Man Over Board

ECDIS = Electronic Chart Display and Information System

GPS = Global Positioning System

AIS = Automatic Identification System

Azipod = The registered brand name of electric podded azimuth thrusters

LORO-vessel = Lift On/Roll On-vessel

1 Introduction

One should consider blackout as a threat no matter which ship he is working on. Blackout occurring in the wrong position at the wrong time might seriously damage the ship, its cargo, crew or passengers. Many sailors have experienced blackout and even we have during our relatively short careers. Knowledge of blackouts is often quite poor among sailors and this is why we decided to study the matter a bit deeper.

1.1 Objective

Our main goal was to improve our knowledge on the subject. We wanted to describe possible reasons for blackout and proper ways to react on the bridge when it happens. We wanted to prepare ourselves and the reader for facing blackouts onboard and increase the level of understanding towards it. We also wanted to find out if we would be able to construct a simple checklist for the bridge team which could minimize the risk for human error during blackout situations.

1.2 Problem formulation

Checklists are good to have during crisis situations but is it a good tool when you find yourself in a middle of a blackout situation up on the bridge? Can you make a universal checklist that suits all ships and all conditions? Can you compensate the lack of education and experience with a good checklist? These are questions that this thesis aims to provide an answer.

1.3 Delimitation

This thesis focuses mainly on blackouts occurring in coastal waters. Open water blackout is not equally dangerous and does not require as fast actions as the blackout in coastal waters. Also other kinds of crisis situations (fire, abandon ship, MOB) and details on what happens in the engine room during blackout are left outside of this thesis.

The credit for this thesis should be divided equally between Roos and Virkkunen. Both students were always present when the work was composed.

2 What is blackout?

Blackout is a temporary loss of electricity production that might lead to loss of manoeuvrability. Most of the ships equipment needs electricity in order to operate. During blackout electricity is not generated and therefore multiple equipments do not function properly (or at all). This thesis limits blackout situations to three categories which determine the severity of the situation.

In case of blackout, energy consumers are considered as either essential or non-essential. Essential energy consumers are for example rudder pumps, navigational equipment and emergency lights. Non-essential equipment includes air conditioning, accommodation lights (excluding emergency lights) or fuel separators.

2.1 Level one

Level one blackout does not present significant threat to the safe navigation of a ship. Level one blackout might occur if electricity production capacity is temporarily lowered (for example failure of one auxiliary engine). This might result in loss of some non-essential equipment and possibly is not even noticeable outside the engine room.

2.2 Level two

Level two blackout is the outcome of complete loss of electricity production which leads to lowered manoeuvrability due to loss of propulsion. During level two blackout the backup system works and the emergency power source starts to feed electricity to the rudder pump. This enables the use of the rudder but one should note the delay for the emergency system to kick in as well as the limited effect of the rudder used without propulsion.

2.3 Level three

Level three blackout is the most severe and it leads to complete loss of manoeuvrability. This is because the emergency system doesn't function properly or the cause for the blackout is related to major engine problem. During level three blackout the ship has to manage without propulsion or rudder.

3 Electricity onboard

3.1 Electricity consumers

There is a high demand of electricity around a ship. It is needed for:

- manoeuvring equipment (rudder, pitch propeller)
- navigational equipment (radar, ECDIS, navigation lights)
- other bridge equipment (AIS, remote anchor release)
- deck machinery (winches)
- electric cargo units
- safety systems (WT-doors, fire alarms/sensors, automatic fire fighting equipment)
- internal and external communications
- everything involved in accommodation systems (lightning, water supply, air conditioning, heating)
- hydraulic equipment (stabilizers, ramps, hatches, cranes)
- engine room systems (fuel pumps, cooling water pumps, ventilation)

Modern ships may be equipped with so called electric podded propulsion unit, meaning that it generates all the propulsion power within the propeller unit. Therefore no propeller shaft is connected straight to the propeller, only electric cables providing the electricity to the electric motor. (Laivakonetekniikka; Ship Knowledge p. 250)

3.2 Electricity production onboard

The electricity can be generated by using shaft generators, auxiliary engines, emergency generator, steam turbine generator, gas turbine generator or by taking the electricity from land. While navigating in coastal waters or when entering a port, the electricity is often produced using auxiliary engines. This improves the navigational safety and is a more stable system compared to shaft generators. The operation of the shaft generator often depend on fixed propeller shaft RPMs and a steady load. After generating the electricity it is transferred via cables to main switchboard which is located in the engine control room. From there it goes to primary electricity consumers and/or subsequent smaller switchboards. Blackout may be caused by a

malfunction in some of the switchboards. (Laivakonetekniikka; Ship Knowledge p. 250)

3.3 Providing electricity in emergency situations

The Classification Society demands that a cargo ship over 500 gross tonnage, a passenger ship and a fishing vessel must be equipped with an emergency power source. The emergency power source guarantees electricity supply if normal electricity production fails. This enables proper operation of certain vital functions which are listed on the next page. (Ship Knowledge, p. 308; Laivakonetekniikka)

The power source might be either an accumulator battery system or an emergency generator. Batteries are only used in small ships. The power consumption on larger ships (or ships carrying more than 32 passengers) is so big that battery capacity just wouldn't be enough or it wouldn't be practical to equip a ship with an army of emergency batteries. For this reason, an emergency generator is the most common solution. (Ship Knowledge, p. 308; IMO Resolution A.325(IX))

In addition to main emergency power supply the ship is equipped with many independent battery systems. These batteries must be connected to at least machinery automatics, fire alarms, radio equipment and emergency generator start. These batteries must not be confused to the accumulator batteries acting as the main emergency power source. (Ship Knowledge, p. 308; IMO Resolution A.325(IX))

The emergency power source must be located above the freeboard deck (weather deck). It must be accessible from outside and it cannot be placed forward of the collision bulkhead. (Ship Knowledge, p. 308; IMO Resolution A.325(IX))

Table 1. Emergency power unit must provide the power for the following items.

Item	Passenger ship	Cargo ship
Embarkation lights	36h	3h
Emergency lights	36h	18h
Navigational lights	36h	18h
Internal communication equipments	36h	18h
Navigational equipment	36h	18h
Fire detection, fire alarms, fire signals	36h	18h
Ship whistle, signal lamp, manual fire alarms, internal emergency signals	36h	18h
Fire pump	36h	18h
Automated sprinkler pump	36h	-
Emergency bilge pump and valve system	36h	-
Emergency steering	30 min (ships +10 000 GT) 10 min (other ships)	30 min (ships +10 000 GT) 10 min (other ships)
Water tight doors	30 min	-
Elevators	30 min*	-

*the elevator must be capable for 30 minutes to return the lift car back to deck level and open the doors so no one gets trapped inside

(IMO Resolution A.325(IX); SOLAS Chapter II-1 regulations 29 (14) and 43 (2.6.1))

3.3.1 Emergency generator

Onboard traditional vessels equipped with a propeller shaft the electricity is produced in sea condition by shaft generator. If the shaft generator fails, emergency generator takes over. One electricity production system must be stand-by in order to minimize the time without power in case of blackout. The emergency generator is constantly sensing the flow of electricity within the ship: if the current alterations cross pre-set limits, the emergency generator starts automatically. In coastal waters and narrow passages the electricity is often produced by auxiliary engines to increase safety. (Ship Knowledge, p. 250, 308; Laivakonetekniikka)

The emergency generator must be equipped with two independent starting systems. The crew must be able to start the generator manually by hand in case of total power loss. Manual starting equipment might be a set of batteries, pre-pressurized start air system, spring starter, hydraulic accumulator or an explosive charge. (Ship Knowledge, p. 250, 308; IMO Resolution A.325(IX))

The emergency generator is a totally independent system and it is supposed to automatically start within 45 seconds. It must be able to start with a list of 22,5 degrees. The generator has its own cooling system and separate fuel supply. The capacity of the generator depends on the consumption of the emergency equipment. (IMO Resolution A.325(IX))

The generator must be separated from the main generators and it has to have its own switchboard with transformers, starting batteries or starting air unit, fuel tank, starting-relay box and a lightning board. All these equipments must be placed in the same compartment with the generator. (Ship Knowledge, p. 250, 308; IMO Resolution A.325(IX); Laivakonetekniikka)

3.3.2 Uninterruptable Power Source

Uninterruptable Power Source is commonly abbreviated UPS. In practice it is a set of batteries located in close proximity to the bridge. The electricity to the navigational equipment is directed through the UPS-batteries which enables the batteries being simultaneously and constantly charged. In case of a temporary power loss the UPS-batteries provide the electricity needed for essential navigational equipment. An audible and visual alarm should be placed on the bridge to inform about a possible

fault in the UPS-system. (Note: The UPS-battery does not work as a single emergency power source and cannot be considered as an alternative to the emergency generator.) (Laivakonetekniikka; IMO COMSAR/Circ.32)

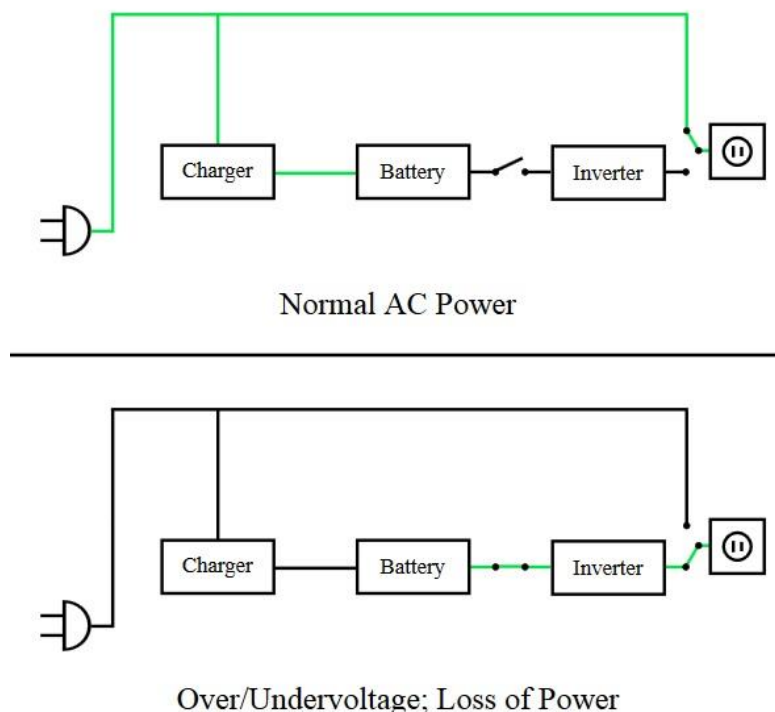

Figure 1: UPS-chart (Wikipedia)

3.3.3 GMDSS-batteries

Ship must be able to send a distress call even during total loss of power. Therefore a ship is equipped with a separate set of batteries designated only to power GMDSS-equipment in a case where all other means to produce electricity fail. These batteries must provide electricity as follows:

- 1 hour onboard a ship equipped with an emergency power source
- 6 hours onboard a ship without an emergency power source

The battery system must be able to switch from A/C to battery supply automatically. Battery system must be equipped with a charger which keeps the batteries full constantly. This charger must be also connected to the emergency power supply in addition to the main power supply. (SOLAS chapter IV, Regulation 13)

4 Reaction in case of a blackout

What to do in case of a blackout is very ship specific. Every ship is unique when considering engine room lay out, emergency electricity supply and bridge equipment. Therefore plans on how to deal with a blackout must be prepared onboard every ship individually. It is challenging to find an exact truth on how to prepare for a blackout.

4.1 Checklist

Checklist is a tool that reduces the risk of human error by stating clearly step-by-step how to react in certain emergencies. It is mandatory to have ship specific checklists designed separately for multiple different scenarios like for example blackout. The ISM Code states: *“The Company should establish procedures for the preparation of plans and instructions, including checklists as appropriate, for key shipboard operations concerning the safety of the ship and the prevention of pollution.”* (ISM Code Part A regulation 7)

4.2 Actions to be taken on bridge

This thesis recommends that the OOW determines the level of the blackout. Once the blackout occurs, it might be that the OOW has only bad choices to choose from. In that case he must be able to select the least bad one. The selection process comes easier if the OOW realizes the threat of blackout and has considered his possible actions beforehand.

Level one blackout doesn't affect the safe navigation in any way. During level two blackout, some of the ships control is maintained. This is because the emergency generator starts feeding electricity to the rudder pump and therefore maneuverability is partially restored. The Classification Society demands the emergency generator to start within 45 seconds and OOW must be aware of this delay. During level three blackout the propulsion is lost and the rudder is not functional. The ship is drifting without control and there is not much that the crew can do. Anchor may be released mechanically but the capability to stop a moving ship using anchor is limited.

Things to consider when facing a blackout situation:

- determine the level of the blackout
- alarm necessary crew members
 - captain, chief engineer, watchman
- be aware of prevailing traffic situation and note terrestrial surroundings
 - moving targets: position and predicted movement of other ships
 - fixed obstructions: water depth, islands, sea marks (buoys, lighthouses), landmarks (bridges, windmills)
- be aware of the forces acting on your ship
 - prevailing weather conditions: wind (speed and direction), current (force and direction)
 - speed and heading of your vessel when the blackout occurred
 - the angle where the rudders were when they last were controllable
 - propeller pitch
- characteristics of your vessel
 - number of propellers, left or right handed propeller
 - ship type
 - draft
- know your rudder
 - be aware of existence of potential non-electric emergency steering systems (for example pressurized gas driven)
 - note the lowered manoeuvre speed of the rudder when using fewer pumps
- write down time and position
- silence alarms
 - acknowledging and resetting alarms is secondary, getting rid of the distracting noise is priority
- steering
 - reduce speed (if possible)
 - determine if the steering controls are working on the bridge (override tiller)
 - monitor how the helm is responding
 - go to hand steering and deploy helmsman if needed

- establish emergency steering capability if other means fail
- when using pitch propellers, set levers to zero position
 - if the lever is left to the position where it was before the blackout it might lead to a situation where the ship starts to alternate its speed automatically when the system is restored without the bridge team noticing it
- emergency anchoring
 - try to find a good anchoring area
 - alert necessary crew members to be stand-by for possible anchoring
 - do not drop the anchor with excessive speed (the chain might break)
 - determine which anchor to use (keep in mind where the ship is turning)
 - anchor chain length according to water depth
- inform others
 - radio notification (other ships, VTS)
 - “not under command” –signals (night time two red lights, daytime two balls in a vertical line)
- close all water tight-doors
 - if the situation demands OOW must be ready to close all water tight doors. OOW must also know that some doors might demand emergency operation locally and send a watchman to the emergency closing location. (This only applies to ships equipped with remotely controlled WT-doors and is more relevant to passenger vessels.)
- Master informs rest of the crew and passengers about the situation
 - announcement on the loudspeaker
- Master alarms land based organizations according to the plan
 - company (CSO, DP), MRCC

UPS works as a temporary power source for the bridge in case of a blackout. It has very limited capacity and the crew must note that it lasts only a while. If the emergency power source has a malfunction, the bridge will lose most of its devices once the UPS system runs out of electricity.

(M/S Amorella blackout checklist; M/S Finneagle blackout checklist)

4.3 Actions to be taken in the engine room

Engine crew starts to recover their systems one by one as soon as the blackout hits. Below is provided an actual engine room blackout checklist that is in use onboard an unnamed vessel.

BLACKOUT RECOVERY CHECKLIST		
1.	Evac-pumps	<input type="checkbox"/>
2.	Fresh water pumps	<input type="checkbox"/>
3.	A/C compressor for the switchboard room	<input type="checkbox"/>
4.	Semco water mist system	<input type="checkbox"/>
5.	KaMeWa pilot pump	<input type="checkbox"/>
6.	Reefer sockets	<input type="checkbox"/>
7.	A/C compressor for the telephone central	<input type="checkbox"/>
8.	A/C compressor for the server room	<input type="checkbox"/>
9.	Separators	<input type="checkbox"/>
10.	Oil Fired Boilers	<input type="checkbox"/>
11.	Engine room water pumps	<input type="checkbox"/>
12.	Engine room oil pumps	<input type="checkbox"/>
13.	Ventilation	<input type="checkbox"/>

Figure 2. Engine room blackout checklist.

4.3.1 Emergency steering

If steering capability from the bridge is lost, OOW/Captain should commence the emergency steering procedure. The procedure includes placing one person who is taking care of the emergency steering in the rudder pump room. The rudders can be

operated locally if some power is provided. In case of a total loss of power, external hydraulic pump unit should be available. The pump unit may be a combustion engine unit or a compressed air unit. (Merenkulun perusteet 2, p. 41-42)

Emergency steering varies from ship to ship. When an officer comes onboard a new ship he should familiarize himself with the ship specific emergency steering. Emergency steering exercises are a part of regular drills onboard. Emergency steering drill must be organized at least once every three months. The drill must take place within the emergency steering compartment, the communication means between the bridge and the steering post must be tested and also where applicable the operation of alternative power supply shall be tested. (Merenkulun perusteet 2, p. 41-42; Solas, Chapter V, regulation 26)

4.4 Possible outcome of a blackout

Blackout might generate complete loss of maneuverability. Blackout is a risk that every ship faces and it often surprises the crew completely. It is a serious safety threat that might lead to:

- damage to the ship
- grounding
- collision with another vessel
- sinking of the ship
- environmental damage
- loss of life
- cargo damage
- delay in schedule
- affecting the prevailing traffic situation and maybe generating more dangerous or close call situations

Blackout might also cripple a vessel. Air conditioning and domestic water needs electricity and life onboard without them becomes quickly quite uncomfortable. Recovering from a blackout demands maintenance resources and might cost extra money to the company in spare parts.

4.5 How to recover from a blackout

When the blackout situation is over both deck and engine crew must go through a thorough equipment check. Bridge team must for example check that their navigational equipment (radar, compass, GPS) works properly and that the ship devices (rudder indicators, navigational lights, helm) do not malfunction. Also radio equipment, UPS-system and GMDSS-batteries must be checked. The Captain must keep the company and officials up to date about the ships situation and possible delays must be handled accordingly. Also inform third parties if the ship made any damage (buoys, other ships) during the blackout situation. Remember to keep also crew and passenger well informed about the situation.

5 Reasons for blackout

Blackout might present itself without any predicted reason. It is often only a chain of unlucky events leading to drastic consequences. Sometimes the blackout is generated by a human error. By closing a wrong valve in the engine room or by handling the controls inconsiderably one might intentionally generate a blackout.

Fire in the main switchboard, changing the fuel filters or sudden changes in the flow of electricity are examples of the reasons in the engine room for blackout. Also dramatic main engine failure often leads to blackout. Fuel pumps might break or lube oil pressure might disappear. The engines are also equipped with automatic protection systems. So if any action makes the engine for example over heat it has the capability to shut itself down independently. (Marinersgalaxy)

5.1 How to prevent blackout situations

Good level of maintenance in the engine room is maybe the best way to prevent blackout. While sailing the engine crew must give attention how they are organizing the ship's electricity production. If the ship is relying on only on shaft generator the risk for it failing and leading to a blackout increases if compared to dual shaft generator. (Personal communication with Hannu Yli-Heikkilä; Marinersgalaxy)

The bridge team must inform the engine crew about the sailing conditions. When making way in narrow or heavy traffic passages it is justified to use more stable

electricity production than in open waters. Also weather conditions affect the probability of a blackout. For example heavy winds/waves and ice conditions might increase the risk for blackout by making the engine work load highly variable. Also ship specific characteristics in certain situations must be in common awareness of the bridge team. Example could be predetermined fixed sailing speed. (Personal communication with Hannu Yli-Heikkilä)

When designing a new ship one can make the vessel more resilient to blackouts by giving extra attention to engine room features and propulsion specifics. Diesel generated propulsion (i.e. Azipod) is free of mechanic connection between the engine and the propeller and is therefore the ship is less probable to face a blackout. Diesel electric propulsion also is quite versatile in means of selecting electricity production. The ship is like a huge power plant where all the engines only generate electricity which is then equally used for powering the propeller as it is for heating the sauna. (Personal communication with Hannu Yli-Heikkilä; Marinersgalaxy)

5.2 Other causes for loss of control on bridge

Maneuverability might be lost for countless reasons. Blackout is just one of them but the procedure to react to other causes resembles highly on the details presented in this thesis. Bridge electricity distribution failure or rudder/propulsion failure are examples of such events.

6 Land based organizations

Many land based organizations monitors and keeps records about blackouts occurring. Finnish Transport Agency and local Vessel Traffic Service were able to provide us detailed information about reported blackouts occurring under their jurisdiction. Below is a chart showing the number of blackouts in the Finnish VTS/GOFREP-area 2011-2014 provided by the Finnish Transport Agency. We also paid a visit to the VTS center where we interviewed a shift supervisor about their protocol of actions if a blackout happens within their area. (Personal communication with Joonatan Ahlroos; Archipelago VTS Master's Guide)

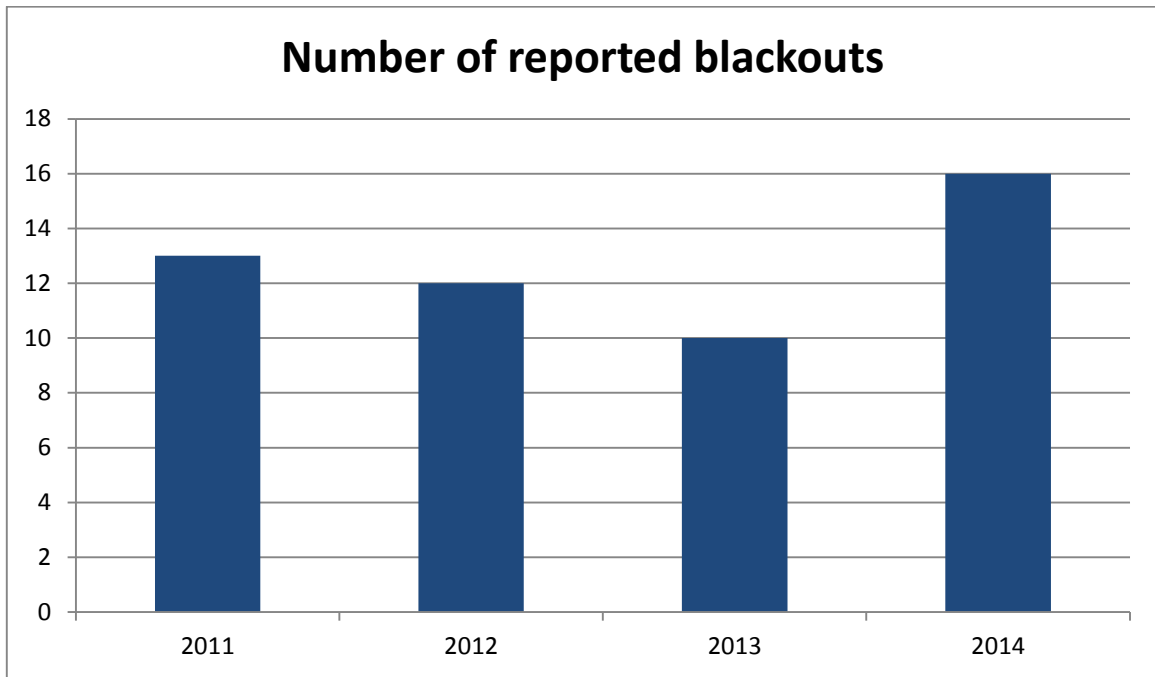

Figure 3. Number of reported blackouts in the Finnish VTS/GOFREP-area 2011-2014. (Finnish Transport Agency)

Master of a ship is obliged to report any significant event concerning the safe navigation of the ship. These might be for example: blackout, unexpected ice findings, heavy building of ice on outer structures of the ship, tropical storms, ship wrecks or other floating objects that might be harmful for safe navigation. (Merenkulun perusteet 2, p. 159; Archipelago VTS Master's Guide)

Any substantial risk or hazard to the safe navigation must be reported to the VTS. This includes even near miss situation. Informing the VTS is highly important. This way the VTS operator is able to warn other traffic of potential hazards. Contacting VTS in an abnormal situation might lead to an official investigation because VTS is obliged to report all matters to the supervising authorities. Pilotage is often included in the VTS-area, so big part of the reporting responsibility lies on the state pilot. If the ship is sailing with a pilot exemption, the reporting responsibility is up to the Master of a ship. Unfortunately the common reporting practice doesn't favor coming to the spotlight with near miss situations. This might lead to ignoring serious safety threats and therefore might cause an accident in the future. The reports are used to build a statistical database which enhances the identification of possible threats concerning safety issues. (Merenkulun perusteet 2, p. 159; personal communication with Joonatan Ahlroos; Archipelago VTS Master's Guide)

Vessel Traffic Service (VTS) monitors sea areas when entering coastal waters with special or restricted navigation. In Finland, plans have been made to make the VTS-area limit start from the sea border but nowadays it starts normally 12 miles before entering a narrow passage. (Personal communication with Joonatan Ahlroos; Archipelago VTS Master's Guide)



Figure 4. VTS operator. (Promotional photograph)

When an emergency happens within VTS-area it is the ships responsibility to report it to the operator. After the report from the ship is made, the VTS-operator starts a pre-planned process to forward the message to the responsible emergency response party, normally being MRCC. The ship only has to make a report to the VTS and after that VTS takes care of the rest. *(Note: Above only applies to Finnish VTS-areas, always remember to check regional specifications. The Master is responsible for the safety of the ship and in immediate threat of life he is recommended to follow GMDSS procedures.)* (Personal communication with Joonatan Ahlroos; Archipelago VTS Master's Guide)

VTS has a manual which includes actions to be taken in abnormal circumstances. Blackout wasn't part of the Finnish VTS procedures guide but it was included in the part which focused on the procedures in a case of a dramatic engine malfunction. Engine shutdown often might lead to a blackout. The manual is classified so it is not presented in this thesis. (Personal communication with Joonatan Ahlroos; Archipelago VTS Master's Guide)

7 Improvements for ships

Our personal experience from working onboard has shown that some improvements could be justified. We came up with few improvements that could be useable.

Equipment:

- Silence all alarms by a push of a single button
 - During a blackout multiple bridge equipments start to sound an alarm all at the same time. This often leads to loss of focus and resetting the alarms needs an extra hand during a time where one is not easily available. High sound level also makes bridge communication a lot more difficult. This would probably need totally integrated bridge system where all of the equipment is connected to each other.
- Captain call button
 - This already exists in some ships but we think it should be more common. It is a button that sounds an alarm directly in the captain's cabin and the navigation team wouldn't have to dial his number and call him on the phone. This would save crucial seconds during a hectic situation.
- ECDIS-repeater to the engine control room
 - Installing an ECDIS-repeater in the engine room would allow the engine crew to determine to some extent the navigational status and plan their maintenance accordingly.
- Hands free headset
 - Connection with the engine room during blackout is essential but the captain has his hands full with the controls of the ship. Equipping the bridge with a wireless headset connected to the engine room would provide the captain a constant flow of information from the engine room without constraining him to the phone.

Routines:

- Determine high risk areas
 - The navigational team could determine so called high risk areas. These areas would then be informed to the engine room (by phone or by

separate display). When sailing in these areas the engine crew would have to avoid certain maintenance work (ones that could lead to blackout) or be at a higher level of readiness to be able to react if something goes wrong.

- Blackout drills
 - Blackout might be quite rare but it often happens eventually. Training the crew to face blackouts would be effective way to minimize the damage caused by blackouts. At least according to our experience this does not occur anywhere. Training could include emergency anchoring procedures, bridge team preparedness for blackouts, updating and improving checklists or practicing engine room communications.
- Including blackout in the muster list duties
 - It would be helpful for everyone onboard to acknowledge beforehand where they are needed and what are their duties during a blackout. For example watchman could be positioned in the emergency anchoring position and motorman in the emergency steering room.

8 Blackout onboard M/S Amorella

Blackout is an unpredictable happening that might strike any vessel in any situation. Good example of such is the grounding of passenger vessel M/S Amorella in the Archipelago sea of Åland in December of 2013.

Amorella was on a voyage from Turku to Stockholm via Marienhamn. The ship had a blackout during a turn before entering a narrow buoy fairway of Hjulgrund. The blackout caused a total loss of maneuverability and despite using non-electric emergency steering and anchoring the ship ran aground. The ship got a leakage in the forward peak but as only damage it was insignificant and did not present great threat to the ship. With the assist of tugboats Amorella was released and granted a permission to continue its journey towards Marianhamn. The repairs of the damages required dry docking and the ship was out of traffic for a period of six days.

The event was caused by a combination of bad luck and bad management. The blackout happened due to interference in the fuel input for auxiliary engines and the interference was caused by human error in the engine room. The engine crew was

conducting maintenance work on the auxiliary engines' fuel pre-heaters when they managed to get a fuel leak. This led to a need for operating the fuel valves which ended up interfering with the fuel intake of the auxiliary engines. The auxiliary engine failure caused the diesel generators to detach from the ships grid which caused a blackout and a total loss of maneuverability.

During the blackout the ship was in a position which was highly demanding for the bridge crew. During that time the engine crew should not have conducted maintenance work which would have presented a risk for having a blackout. The instructions for conducting such maintenance work did not include any information of the presence of such risk.

(Investigation report of Safety Investigation Authority Finland)

9 Simulator research

9.1 Objective

The objective of the research was to distinguish the necessity of a written aid in a highly stressful situation. It also tries to point out if a checklist can replace proper education and experience in a crisis situation. The research also illustrates how well 3rd and 4th year students are able to perform in a blackout situation. We were not able to find earlier researches with similar objectives.

9.2 Description

Our method of conducting this research was to put maritime students into to a ship simulator and simulate a blackout situation. Participants were divided into two groups: half of the students were equipped with a checklist specifically made for a blackout situation and the other half had to manage without a checklist. The students with the blackout checklist were given also other checklists (fire, SAR, MOB) as "decoys" to avoid any clues about the upcoming events. The simulated event and the bridge equipment available were identical with both groups.

The provided blackout checklist was specially made for this exercise using the data gathered in chapter four. The goal of the list was to suite all ships in all conditions and not to provide any special aids for this particular simulation set up.

We were able to gather 15 maritime students who formed 8 bridge teams which were divided into two groups, Group A (4 teams) and Group B (4 teams). Seven teams consisted of two students and one team had only one student in it. Within the team the students were given roles as either the Captain or as an 1st Officer. The students were allowed to divide the roles within the team themselves but it was recommendable to pick the student with higher amount of sea going experience to act as the Captain of the simulator vessel. Group B was equipped with the checklists and group A had to manage without them.

Conducting this research took two days. Group A did their run during the first day and Group B during the second day. The days were consecutive in order to minimize any information of the exercise of reaching the participants in the Group B. It was highly important that all of the teams stepped into the simulator equally clueless of what was ahead of them. Knowledge gained beforehand would have granted an advantage for a team taking the test.

All of the teams received an identical briefing prior the exercise (except that group B were provided with four checklists and the checklist location was mentioned during the briefing). The briefing took about fifteen minutes and it included gathering participants' background information, ship details, bridge equipment familiarization, communication methods (intership and walkie-talkie), prevailing weather condition, position and route plan. The students were also given a recommendation to maintain sufficient speed in order to keep up with the ships schedule. After the briefing the students were given some time to get acquainted with the bridge equipment and the surroundings. The simulation was started after the team confirmed that they are ready to start. The briefing followed the same pattern with all of the teams and it was confirmed by using a paper stating all the relevant items to the briefing (Attachment 1).

During briefing students were given two UHF walkie-talkies which were set to different channels. They were told that the other one is used to connect to Kotka VTS and the other one is used to reach watchman. They were also told that if they would

need to drop anchor it would be possible by contacting watchman and requesting him to manually drop it. In reality “watchman” was one of the researchers who was sitting in the instructor room and he relayed the command to drop the anchor to the teacher who was operating the software.

In order to run a ship simulation it is necessary to have people to conduct all the “acting” and controlling the simulator software. The simulator control room was manned with two researchers (Roos and Virkkunen) playing the roles of VTS operator, engine room crew and deck crew. Researchers also recorded relevant findings during the exercise. Third person involved was an experienced teacher supervising the exercise and operating the simulator software.

The actual exercise part took about 20 minutes. After completing the exercise the students were interviewed with the focus on the question about their initial plan for action after they realized having a blackout onboard. They were also handed an anonymous questionnaire to be filled in a separate class room right after the exercise (Attachment 2). The questionnaire gathered participants’ personal views on whether the checklist was actually helping or not.

9.3 Participants’ background

15 students took part in this research. 27% of the participants were 3rd year students and 73% were 4th year students so the general experience level was high. 87% of the participants were male. Group A had an average 329 seadays per participant while group B average was 303. The difference is considered to be meaningless. Educationally Group B had slightly more advanced members. 86% of Group B members were 4th year students while the corresponding figure for group A was 63%. Certificate wise group A was slightly more competent: 38% of the members had Deck Officer certificate (OOW) while 29% of group B members had it. Rest of the participants had Watchman’s certificate (OS). Three out of four of Group A teams had a member equipped with OOW certificate while half of the group B teams had such member.

Table 2. Simulation participant background information.

Group A	COC	Seadays	Class	Role
Member 1	OS	130	3rd year	Captain
Member 2	OS	115	3rd year	1st Officer
Member 3	OS	250	4th year	1st Officer
Member 4	OOW	500	4th year	Captain
Member 5	OS	70	3rd year	1st Officer
Member 6	OOW	370	4th year	Captain
Member 7	OOW	1000	4th year	Captain
Member 8	OS	200	4th year	1st Officer

Group B	COC	Seadays	Class	Role
Member 9	OOW	450	4th year	Captain
Member 10	OS	360	4th year	1st Officer
Member 11	OS	100	4th year	Captain
Member 12	OS	140	4th year	1st Officer
Member 13	OOW	500	4th year	Captain
Member 14	OS	210	3rd year	1st Officer
Member 15	OS	360	4th year	Captain

9.4 Ship details

The simulation was done using a LORO-type vessel equipped with own deck cranes.

- Length overall: 173,5 m
- Breadth: 23,05 m
- Maximum draft: 8,1 m
- Two anchors with 11 shackles of chain in each
- Maximum rudder angle 35 degrees
- Single controllable pitch propeller ship with propeller rotating left
- One main engine (power: 9540 kW)
- Maximum speed: 18 knots



Figure 5. Similar vessel to the one used in the exercise. (Hafen-Hamburg)

9.5 Bridge equipment

The exercise was conducted using Transas ship simulator in Aboa Mare training center in Turku. We used two identical bridge simulators which were equipped like a basic ship bridge would be. The relevant equipment for this exercise were:

- two radars
- ECDIS
- 2 walkie-talkies
- steering controls (autopilot, override tiller, manual hand wheel)
- control panel for navigational lights
- conning display (e.g. engine revolutions, propeller pitch and ship movement)
- log book
- written route plan
- list of phone numbers (Attachment 7)
- check lists (for group B teams)



Figure 6. Bridge simulator used in the exercise (Promotional photograph)

9.6 The exercise

The simulation started outside Loviisa harbor and the team was informed that they were heading out of Loviisa. The selected location needed to be such that by taking the correct measures the team would be able to steer the ship to safety. Simultaneously the location had to be challenging enough so that by taking the wrong measures the ship would run aground.

Readymade route plan (Attachment 6) was provided and it was briefly discussed with the team before commencing the exercise. The planned route was also visible on the bridge ECDIS screen. The team was also informed that the ship had a tight schedule and it was not recommended to reduce the speed. They were also told that the ship was sailing within VTS area and that the VTS operator was available if a needed. The team gained the knowledge that also ship's crew was available using intership communications (phone/walkie-talkie) and that anchor lowering (if needed) would happen by contacting the watchman.

The speed at the starting point of the simulation was 10 knots and it was rising slowly. The engine control levers were set to full ahead and at the point of the

blackout the speed had increased to 12,4-13,2 knots depending slightly on the previous actions of various teams.

During the exercise all teams had to enter a narrow passage and make one turn before arriving at the blackout position. The blackout was simulated using the simulator software and it was inflicted to all teams at the same position which was determined using a green buoy.

The team received information about the blackout via phone call from the engine room (simulator control room). They were informed that the situation looks bad and it will probably take some time to fix. This was done in order to emphasize the need of urgent action from the bridge team. The blackout was also visible from the simulator conning display but hardly distinguishable. According to our division this was a Level 2 blackout. This meant that the team had a working rudder but the propulsion was lost. In practice this enabled the team to perform one or two efficient rudder commands before losing maneuverability completely because of lack of speed.

After the blackout the teams were given totally free hands to act the best way they thought possible in that situation. Researchers monitored constantly the actions the team made but did nothing in order to assist in any way. Simulated VTS operator and normal ship crew were available if needed.

The simulated event took place during midday. The weather was clear with the wind blowing 10 m/s from Northeast. No current or significant waves were present. The ship was at full loading condition.

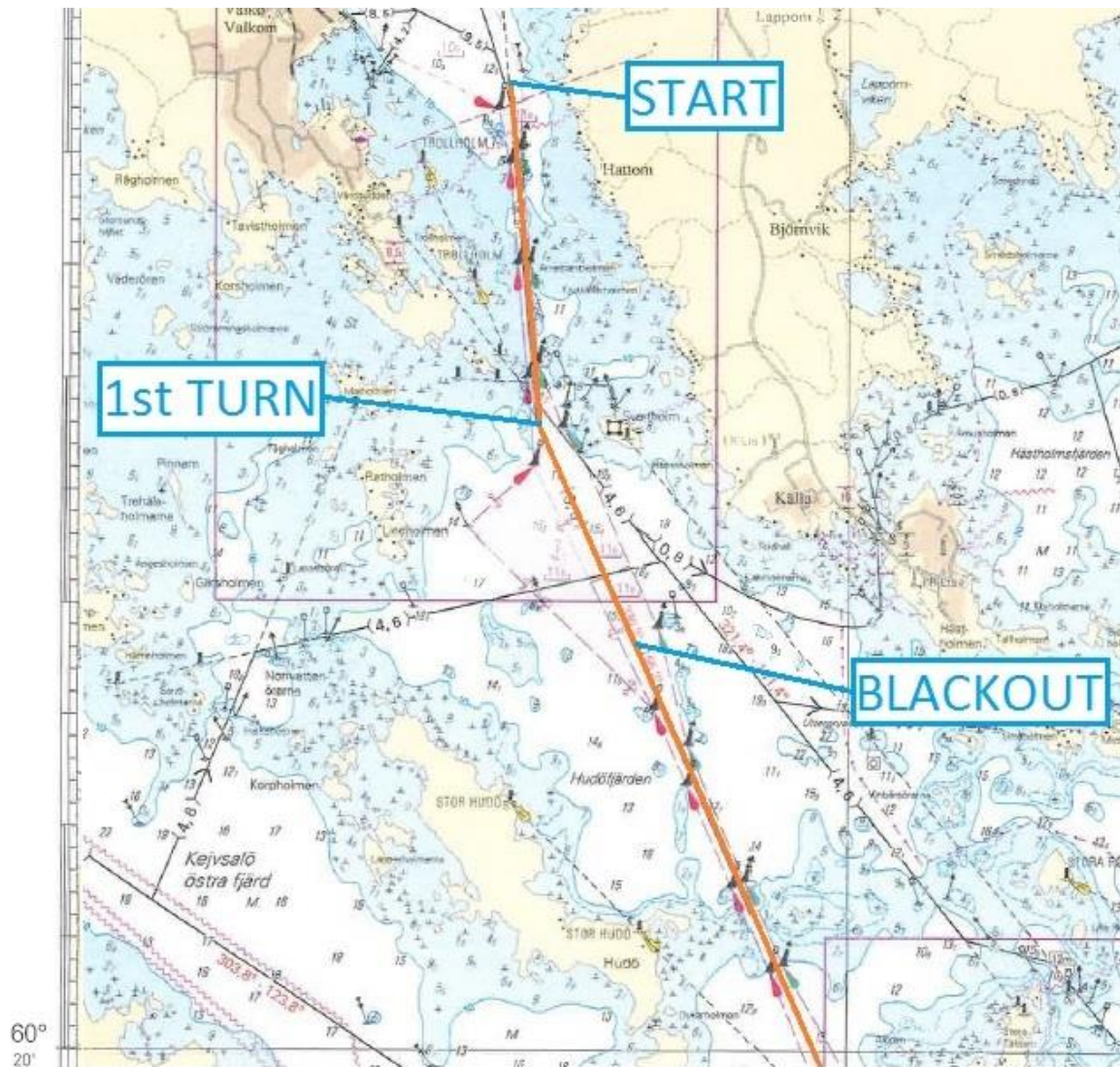

Figure 7. The route illustrated on a paper chart.

9.7 Actions of the teams

Researchers used a separate datasheet to help gather consistent data during and after the simulation (Attachment 1). The group code (A or B) was clearly marked on the datasheet to ensure easy separation of the data afterwards. The collected data is presented in this chapter.

Prior to blackout all teams maintained requested speed and followed the planned course. This enabled equal starting to the blackout situation. After receiving the information that there had been a blackout onboard all of the teams acknowledged it right away and started planning the best way to handle the situation. There was no misunderstanding with any team so any irregularities in the outcome were eliminated this way.

9.7.1 Items on the datasheet and collected data

Item 1: *Inform VTS*

In case of a blackout within VTS area the vessel must report it to the local VTS. The chart below shows that only half of the teams in the group A did the right thing. All of the group B teams contacted VTS accordingly.

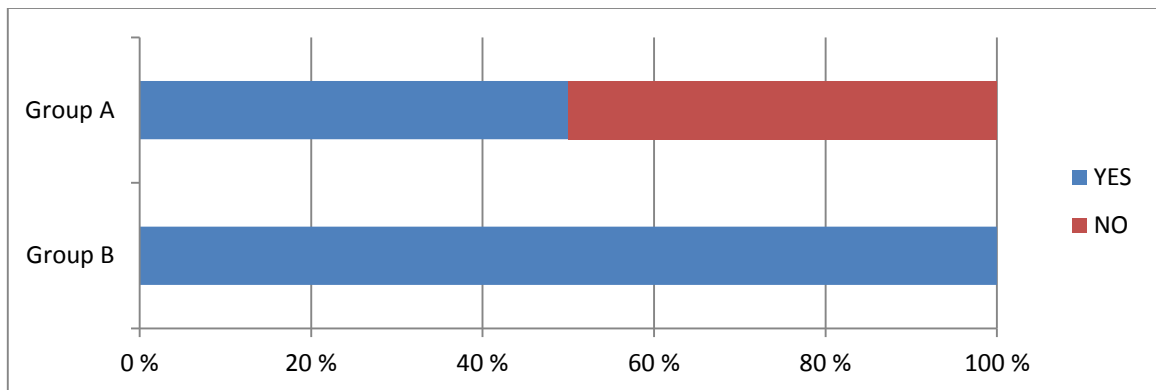

Item 2: *Write down time and position*

During an incident it is important to record time and position for the possible investigation that takes place afterwards. The result shows that one team without the checklist didn't write down time and position.

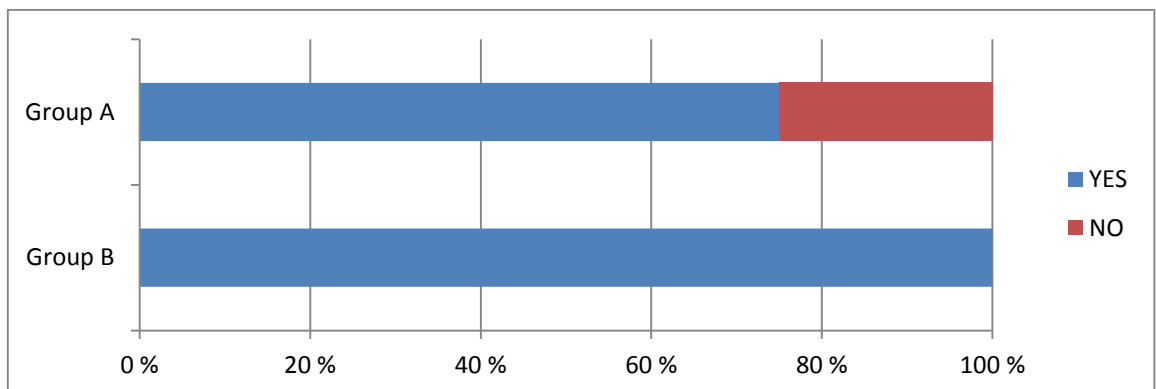

Item 3: *Set lever to zero position*

When the ship is recovering a blackout situation it is important to remember to reset the engine command levers to zero position. If they are left some other way the rudder might start producing propulsion without the crew noticing when the power is restored. Half of the group A teams did not realize to do this.

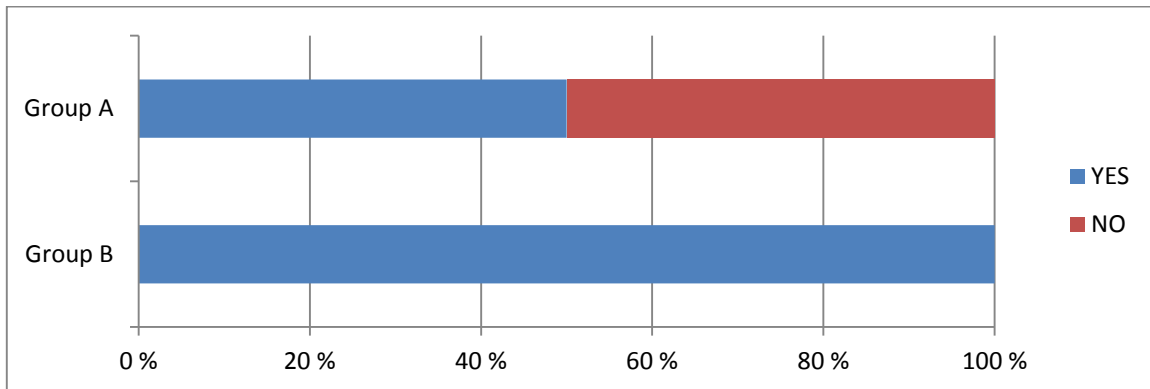

Item 4: *Inform watchman*

The ship used in the simulation was equipped so that the anchor was released locally from the forward mooring station. Quick notice to the watchman after the blackout was important because it takes time to make the anchor ready to be dropped. All teams in both groups informed the watchman.

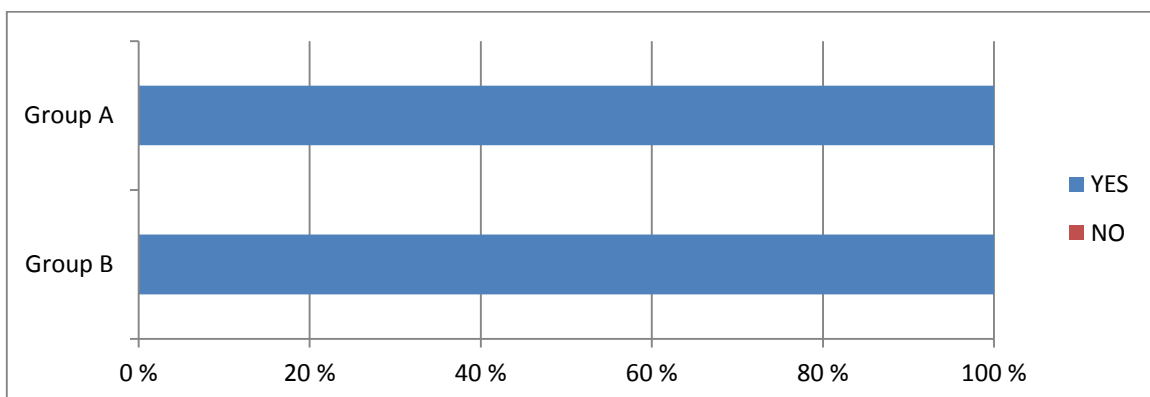

Item 5: *Use of emergency steering*

In this simulation the emergency steering was done by operating either the override tiller or using follow up hand steering wheel. In the latter choice manual switching from the autopilot to the hand steering had to be done. All teams in both groups accomplished to maneuver the ship using emergency steering.

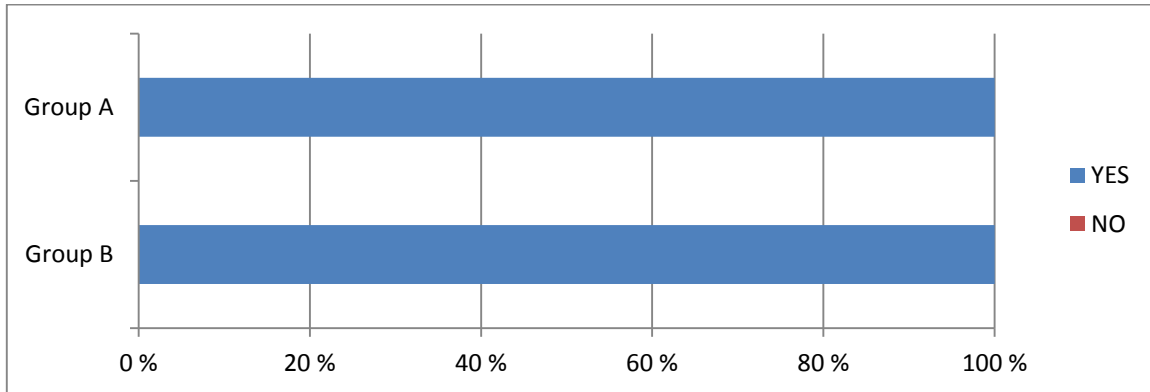

Item 8: *NUC signal*

Not Under Command signaling is important measure to warn other vessels in vicinity about difficulties to maneuver. 25% of the teams without the checklist did not do this.

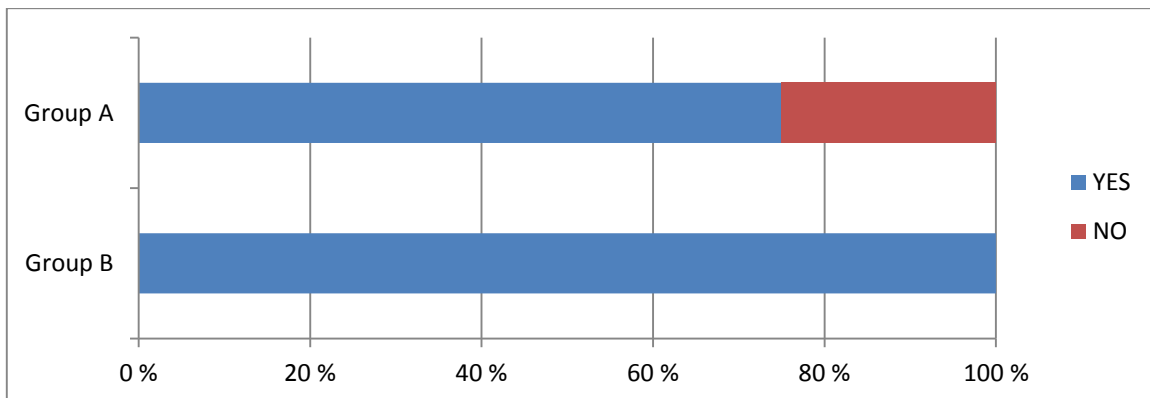

Item 9: *Inform (final) situation to VTS*

It is important for the VTS to know when the situation is not evolving anymore and when proper actions by the rescue and environment officials may commence. All teams contacted the VTS latest when the ships was stationary.

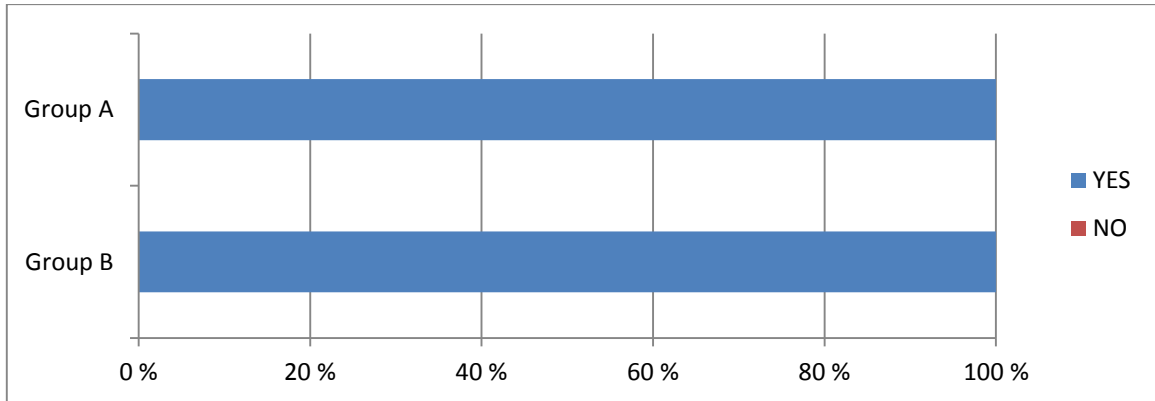

Item 10: *Was the checklist used?*

All teams that were given the checklist used it for assistance in decision making during the blackout.

Items 6 & 7: *Use of anchor*

All of the teams used anchoring as a solution to deal with the blackout situation. Team specific description on the use of anchor is described in the chapter 9.9.

9.8 Exercise outcomes

Simulation ended when the team was not able to do anything to improve their situation or when the situation was under control. All of the teams ended up either anchored or ran aground. No significant difference between group A and B teams can be found.

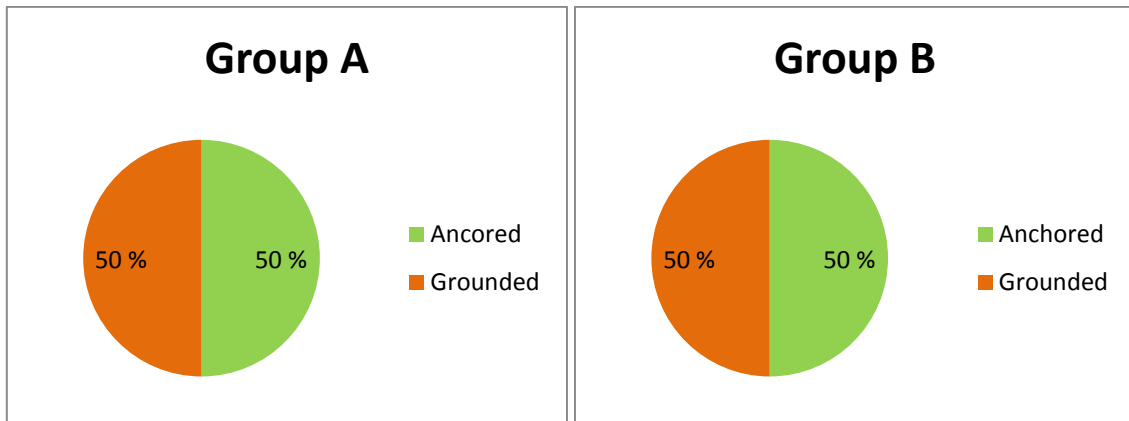

9.8.1 Team specific outcomes

(The order of the teams inside the groups is scrambled in order to maintain anonymity.)

Team A2

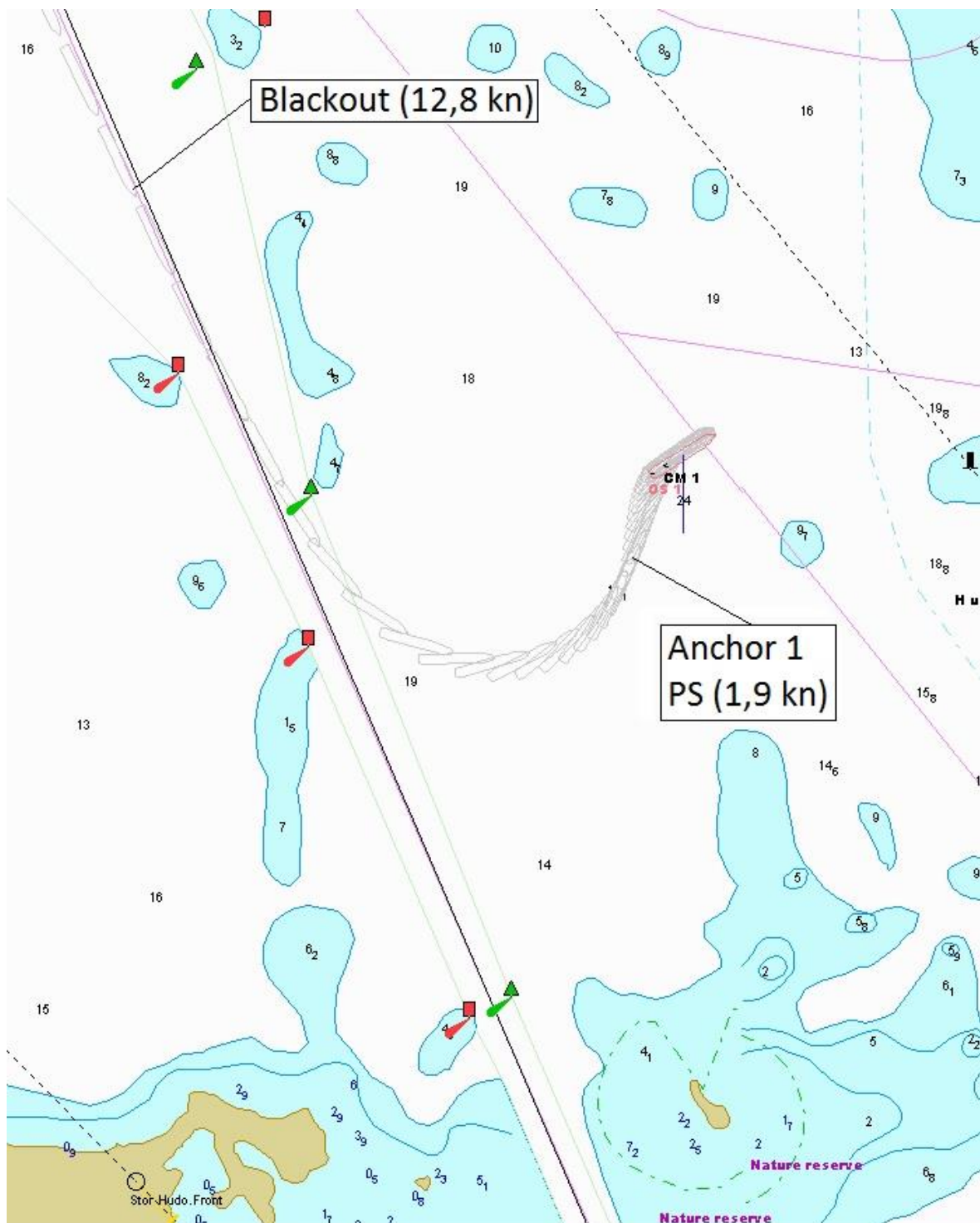

After the blackout the team looked for suitable place to anchor and found one on their port quarter. They executed a hard to port turn after the green buoy and managed to slow down the speed and take the vessel to safe waters. When the speed had dropped to 1,9 knots the team dropped the port side anchor. The anchor held and the team managed to avoid any damage to the ship.

Team A3

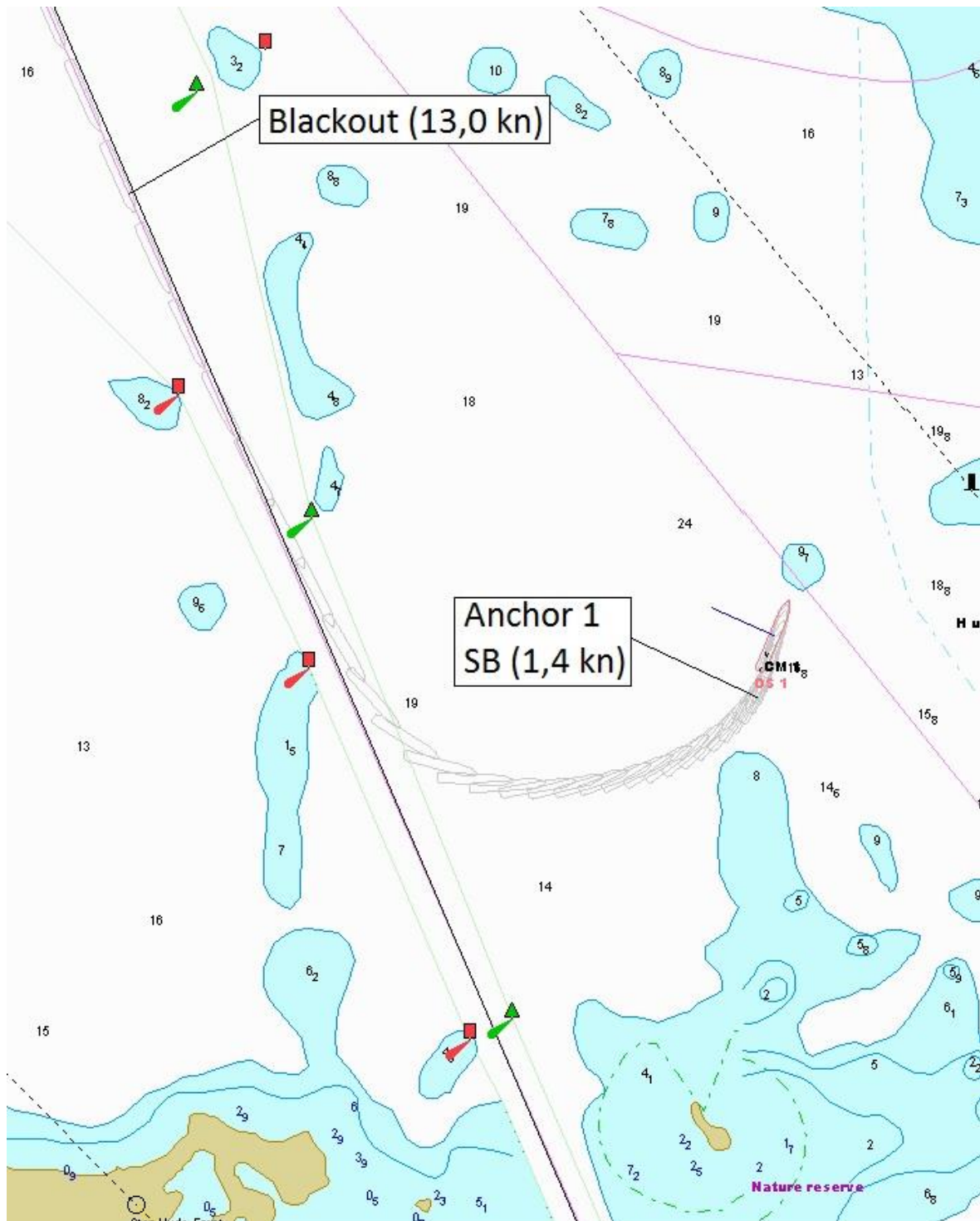

Team A3 followed almost the same path as team A2. The only difference was that they introduced starboard rudder angle during the swing to port. Their plan was to reduce speed with this maneuver but in reality it made their turn radius larger and brought them closer to danger. In the end the team managed to stop the ship using one anchor and they remained anchored in safe waters.

Team A4

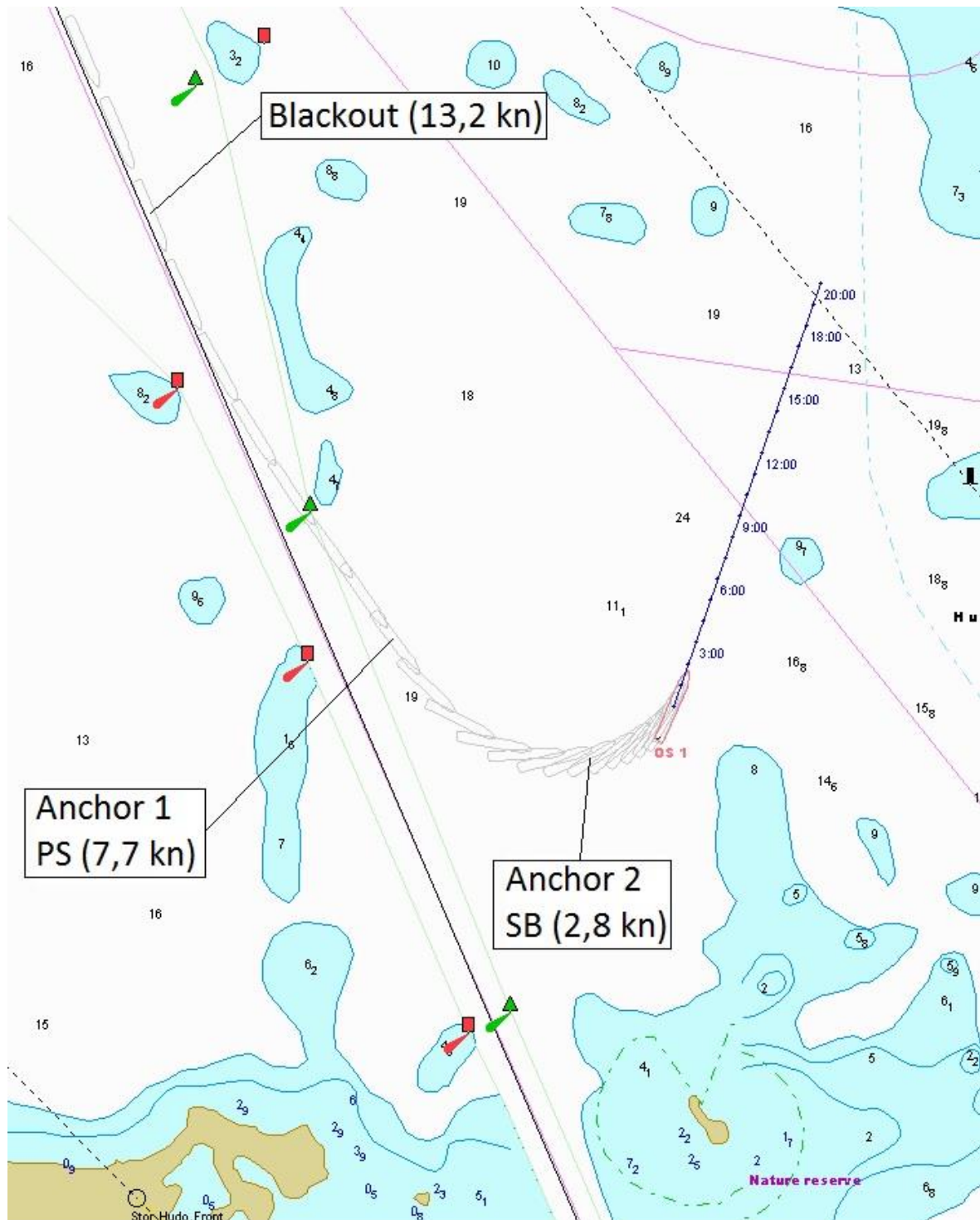

Team A4 also did the swing to port but they dropped the first anchor at too high speed and the chain broke. Second anchor was released while the ship had a speed of 2,8 knots. This was enough to brake the second anchor chain as well. This left the ship drifting and eventually it would have run aground due to Northeast wind. Due to time issues the simulation was stopped when there was nothing to do anymore in order to make the situation better.

Team B1

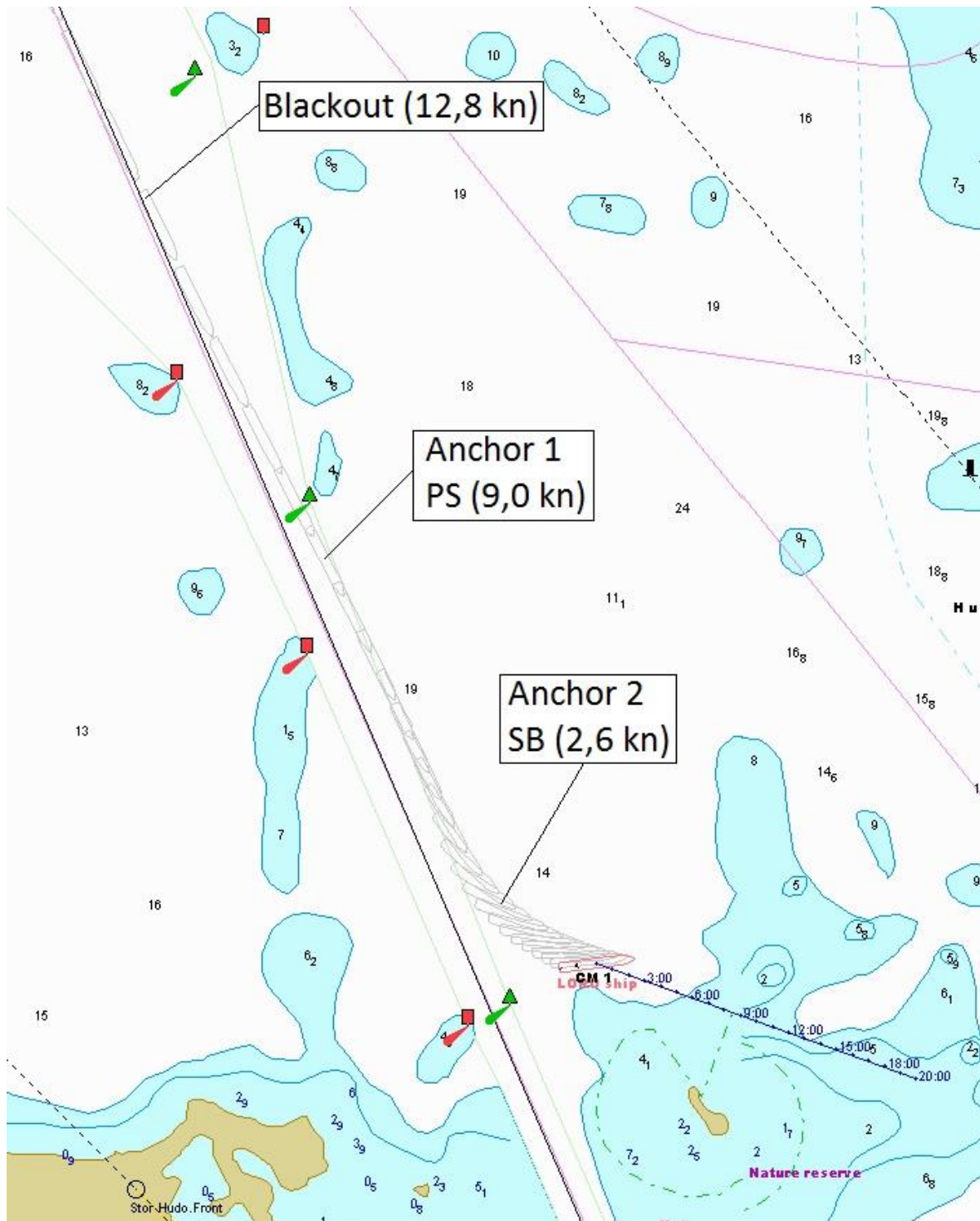

In the beginning team B1 did not use rudder to make the turn but instead dropped port side anchor. Team was planning it would swing the vessel port and slow it down. Due to high speed the chain broke. For a while after losing the first anchor the team used starboard rudder but eventually started turning port. During the turn the team dropped port side anchor but the speed was still too high and the chain broke. Eventually the ship ran aground.

Team B2

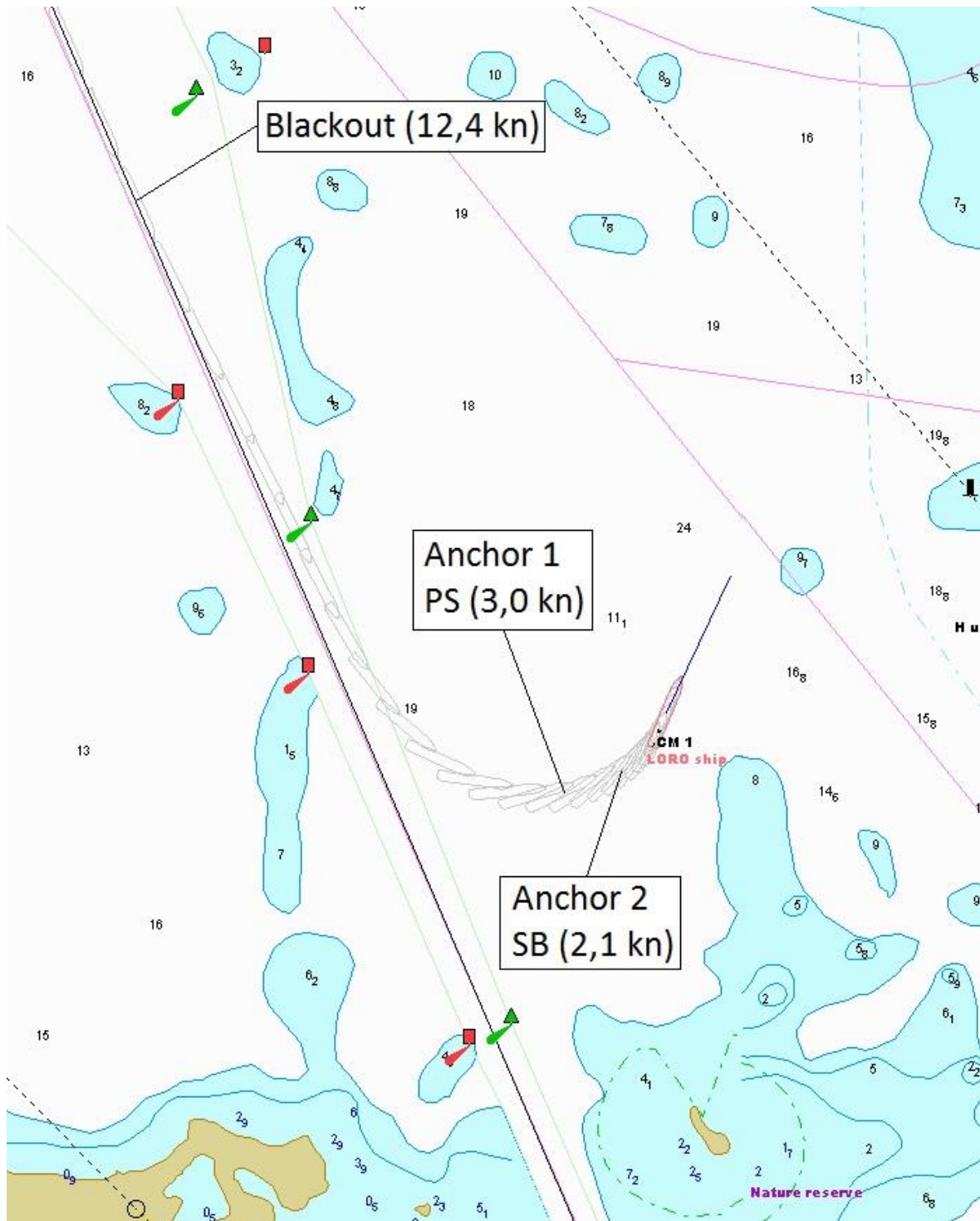

The team informed VTS that they had a blackout onboard. After the announcement the team waited for VTS to provide assistance to deal with this matter. The team was unable to get any additional help from the VTS and they decided to act themselves. They did a port turn and dropped the first anchor with a speed of 3,0 knots. First anchor was lost but second one held. The outcome for this team was that they remained anchored and the ship did not suffer any damage.

Team B3

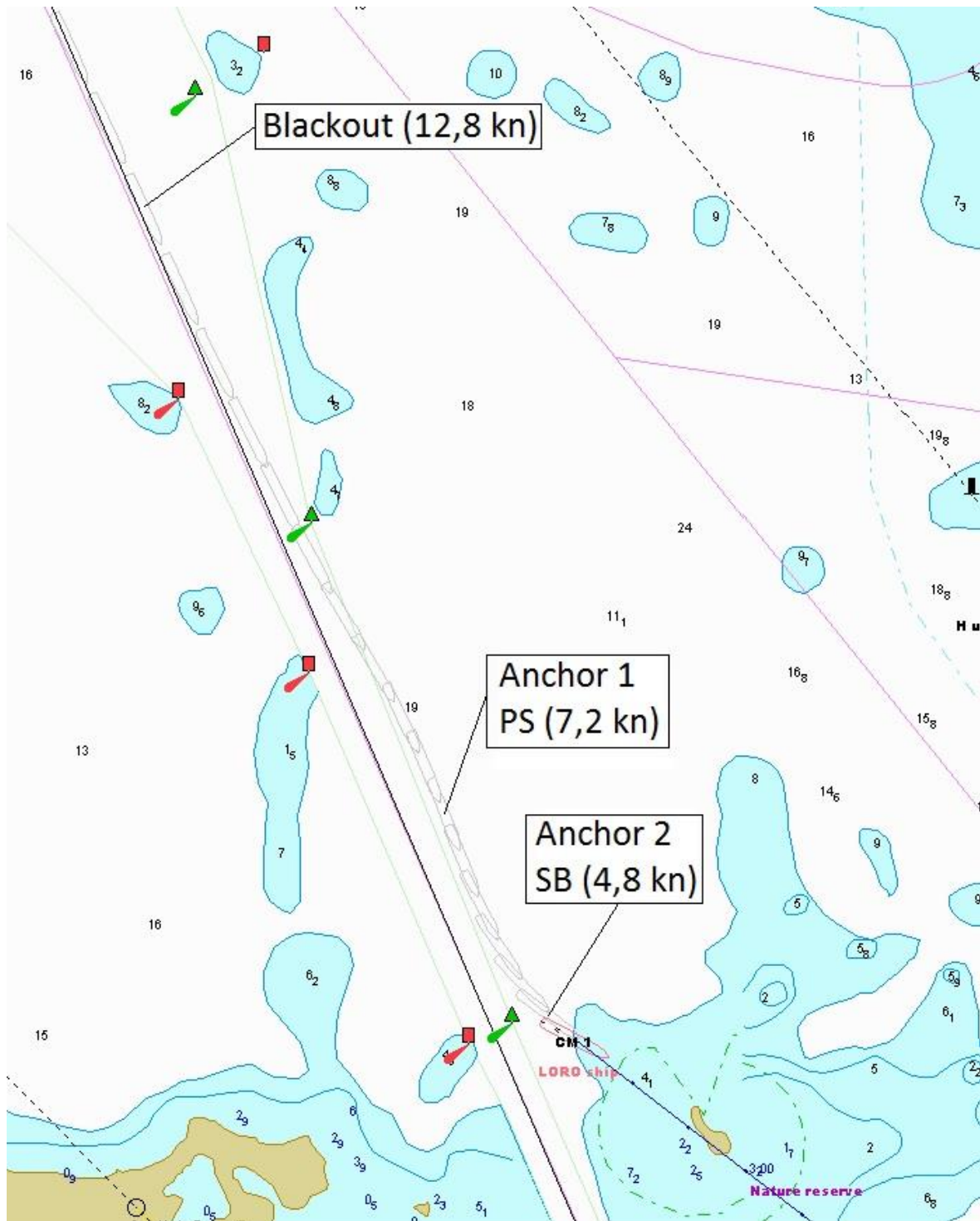

Team B3 tried to maneuver the ship through the narrow channel. They didn't get their heading towards the channel and they dropped their first anchor at 7,2 knots speed but the chain broke. When the green buoy was on their starboard side they had a speed of 4,8 knots and they dropped their second anchor. They had too much speed for the chain to hold and they ran aground with both anchors lost.

Team B4

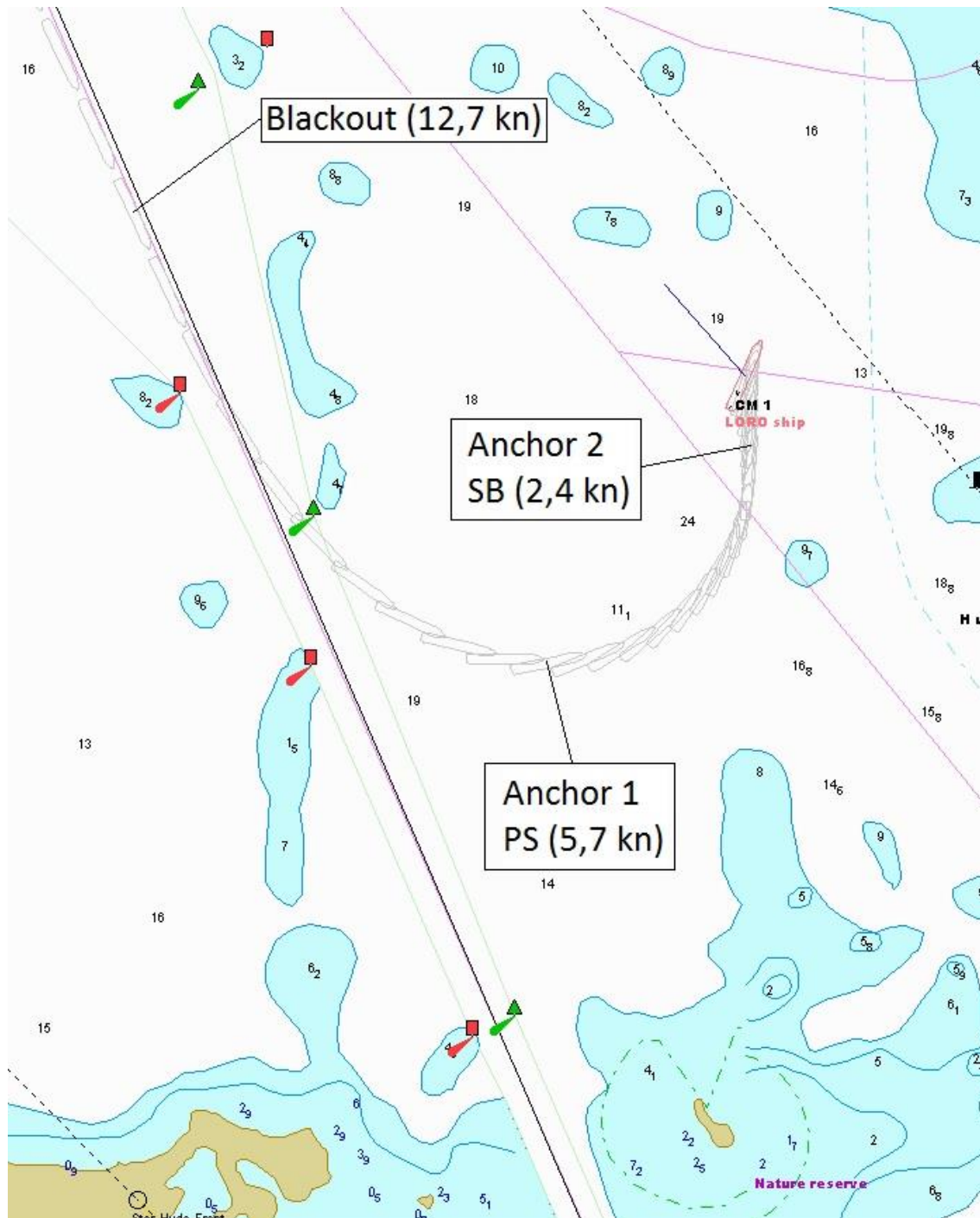

After the blackout the team tried to avoid the first green buoy by introducing starboard rudder angle. After passing the buoy they eliminated any rudder angle and the ship started to turn port because of the wind force. Barely any rudder commands were given during the swing to port. First anchor was dropped when the ship had turned 90 degrees but the speed was enough to break the chain. The ship continued turning and the team released second anchor when the speed had dropped to 2,4 knots. The team remained anchored and avoided any damage to the ship.

9.9 Questionnaire

Question 1: How challenging did you find the situation?

1=not challenging at all

10=very challenging

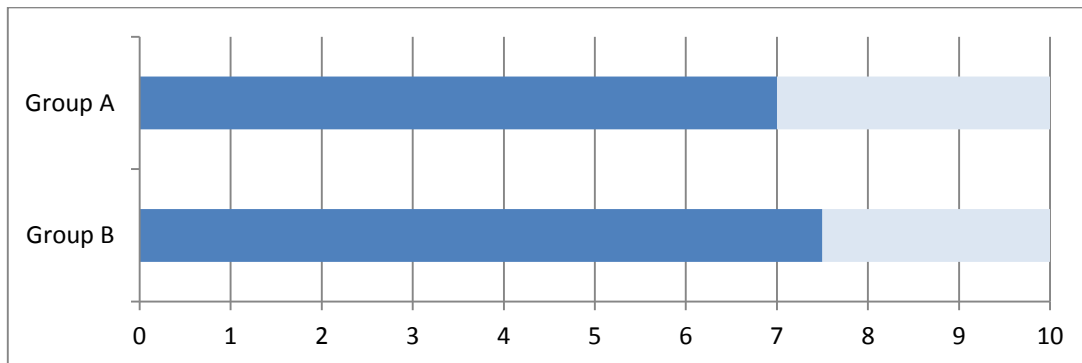

Group A averaged 7,0 and group B averaged 7,5.

Question 2: Do you think you could have managed better by using a checklist?

1=no difference

10=much better

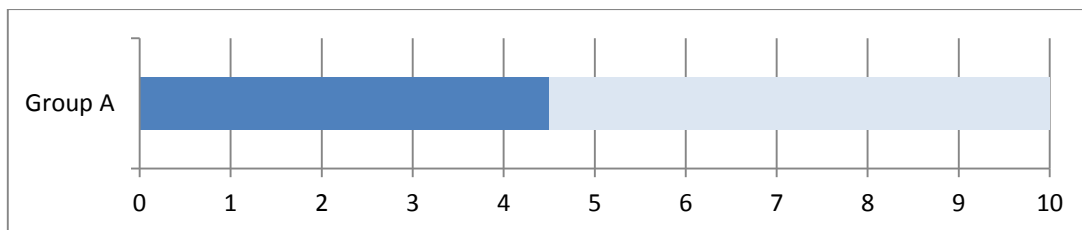

Group A averaged 4,5. Group B did not answer to this question

Question 3: How safe do you think you handled the situation?

1=unsafe

10=safe

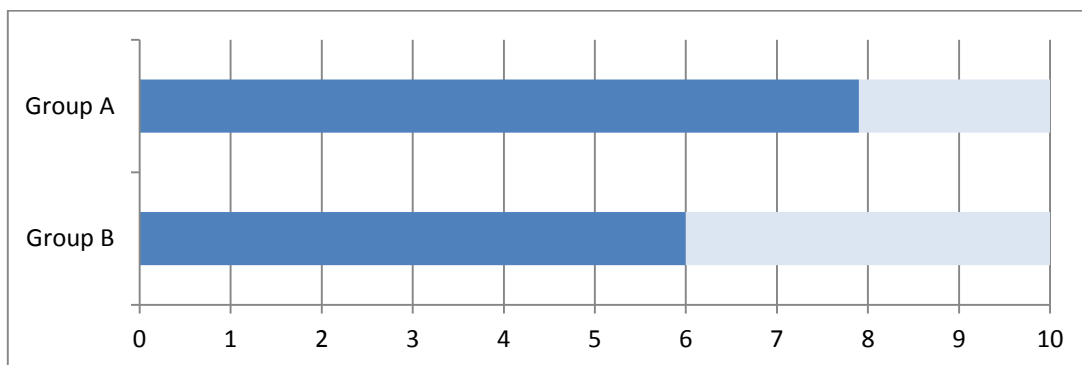

Group A averaged 7,9. Group B averaged 6,0.

Question 4: Are you satisfied with your performance?

1=unsatisfied

10=satisfied

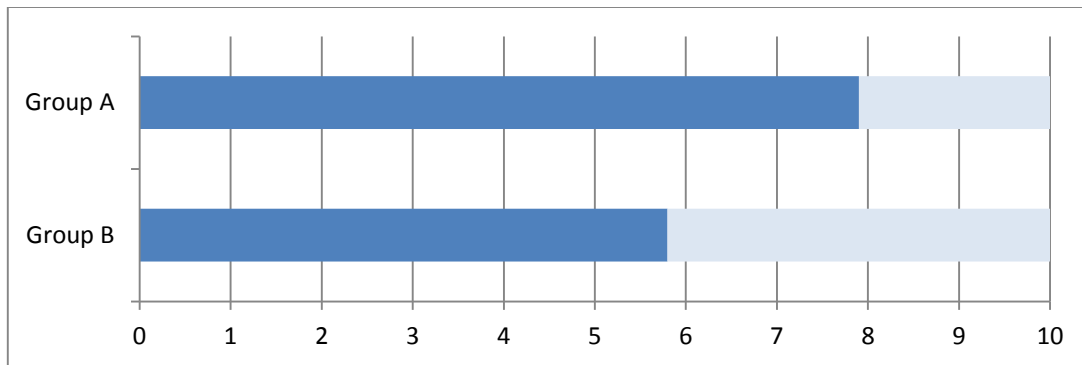

Group A averaged 7,9. Group B averaged 5,8.

Question 5: Estimate what is the probability that you will encounter a blackout situation onboard in real life during your career.

1=probably not

10=most certainly

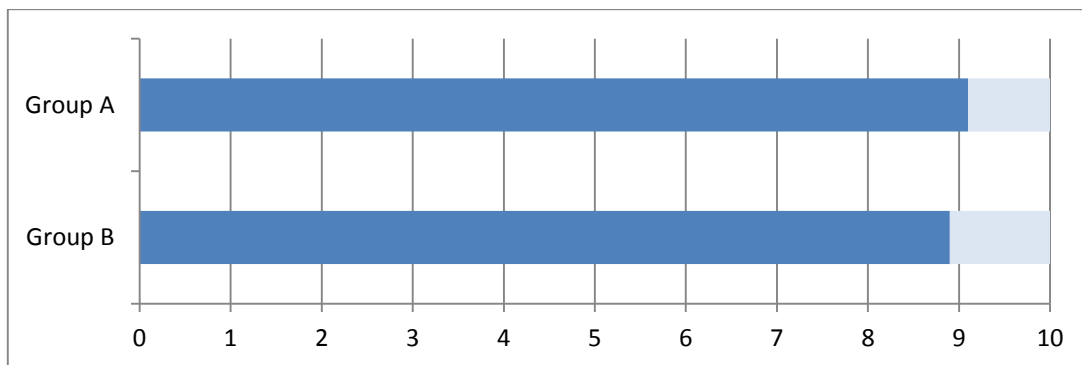

Group A averaged 9,1. Group B averaged 8,9.

9.10 Conclusion

Like statistics about the exercise outcome illustrated no significant difference between groups A and B can be seen when considering whether the ship was safe or not. Performing tasks of small importance improved when using the blackout checklist. These tasks in real situation could lead to bigger problems but this was challenging to point out in a simulator environment. It seems that checklist was not a redeeming feature to survive from an extremely challenging situation.

Questionnaire shows that the teams without the checklist felt like they handled the situation more safely than their colleagues with the checklist. The A group also felt

more satisfied with their performance. This is an interesting fact considering that the performance was actually quite the same between the groups. It might be that the checklist generates fake sensation of safety in situations where you need rapid thinking based on your previous experience and educational background.

Written feedback from the participants pointed out that using a checklist in a crisis situation might even direct ones focus on minor details. Researchers had difficulties of constructing a blackout checklist that would always neglect individual error on decision making and would always direct the ship away from harm's way. It seems like checklists are build for supporting an individual and do not replace the need of situational awareness in a crisis situation.

9.11 Project evaluation

The result of this research is based on a small number of test subjects. 15 people divided into eight groups is not big enough sampling for constructing reliable research data. One of the teams in group B consisted only of one member. Already this fact has impact on 25% of group B data and 12,5% of the whole sampling. Limited amount of simulator facility resources prevented the use of bigger sampling.

The briefing was designed to meet the demands of this simulation and its participants. The briefing contained specific information about the necessary actions to deal with the challenges faced in the exercise. For example anchoring operations were described in detail during the briefing and it probably made the subjects mentally prepared for anchoring even though they were clueless of what they were going to face. This could have made the exercise predictable and the result corrupt. In addition to this the groups did not perform this exercise at the same time so it is possible that also some information was revealed to the later groups from the subjects that had already done the exercise.

The result of this research is based on a checklist made by the researchers themselves. It might be that some other type of checklist could have been able to perform much better in a similar blackout situation.

Providing checklists to group B already gave huge advantage compared to group A because group B teams probably knew to anticipate some kind of a crisis situation to

arise. On the other hand the decoy checklists could have misled some team to strongly expect a wrong kind of crisis to deal with (e.g. preparing for fire alarm).

The surrounding environment and the prevailing traffic conditions in the simulation were predetermined and tested by the researchers when the simulation was constructed. After the blackout the wind pushed the bow of the vessel automatically to port making the subjects instinctively reject the option of turning the vessel starboard instead (the ship was unable to turn to starboard even with high rudder angles). Actually by doing nothing at all made the ship end up in safe waters. This might have aided some students to pick the safest option by coincidence and not because they knew what to do.

In order to ratify our results a subsequent research should take place. A future research could be conducted using a bigger sampling or in a different location with different settings. Also studying psychological factors (stress reaction) during a blackout situation would be a subject for future research.

10 Final words

The thesis was able to deliver answers to the questions given in the introduction part. Theoretical part ignored most of the engine room details which left the technical details of a blackout quite unknown. It is almost important to know the cause for the blackout than it is to react to it. Otherwise theoretical part navigation wise managed to cover most of the important subjects and that was our main goal. Research part provided us with wanted results but the practical implementation was challenging. The sampling was quite narrow and the simulation was done only in one scenario. Bigger amount of participants with different simulation set up could verify our results.

The thesis was constructed as teamwork. This turned out to be very suitable way to work for both of us. The presence of a team mate helped in the moments where lack of motivation was present. It also pursued team members to achieve proper level of quality which was agreed before the work commenced. Both of us learned quite a lot during the process: not only about the subject but also how to be part of a team in a long process and how to contribute towards a common goal.

References

Laivakonetekniikka (2010). *Laivan sähköjärjestelmä*.

<http://laivakonetekniikka.wikispaces.com/Laivan+s%C3%A4hk%C3%B6j%C3%A4rjestelm%C3%A4> (retrieved: 24.2.2015)

Merenkulun perusteet 2 (2nd ed). Piira O., Haavisto J. & Opetushallitus (2008). Helsinki: Edita Prima Oy.

Personal communication with Joonatan Ahlroos, VTS shift supervisor, Turku 25.2.2015

Personal communication with Hannu Yli-Heikkilä, marine engineering specialist at Aboa Mare maritime school, Turku 15.4.2015

Archipelago VTS Masters Guide. Liikennevirasto (2013).

http://portal.liikennevirasto.fi/portal/page/portal/f/ammattiliikenteen_palvelut/meliikenteen_ohjaus/vts/111216_Archipelago_su.pdf.pdf (retrieved: 25.2.2015)

IMO Resolution A.325(IX) Regulation 20 and 21 (1975). *Recommendation concerning regulations for machinery and electrical installations in passenger and cargo ships*.

http://www.imo.org/blast/blastDataHelper.asp?data_id=22175&filename=A325%28IX%29.pdf (retrieved 26.2.2015)

IMO COMSAR/Circ.32 Ref. T2/6-01, page 34 (2004) 7.6 *Harmonization of GMDSS requirements for radio installations onboard SOLAS ships*.

http://www.imo.org/blast/blastDataHelper.asp?data_id=10750&filename=32.pdf (retrieved: 3.3.2015)

SOLAS, Consilidated Edition 2004. IMO (2004) London

Investigation report of Safety Investigation Authority Finland (2014). *Tutkintaselostus M2013-06 M/S Amorella (FIN), sähköhäiriö ja karilleajo Ahvenanmaan saaristossa 14.12.2013*.

http://www.turvallisuustutkinta.fi/material/attachments/otkes/tutkintaselostukset/fi/vesiliikenneonnettomuuskientutkinta/2013/JKQwDPa6B/Tutkintaselostus_M2013-06.pdf (retrieved: 5.5.2015)

M/S Finneagle Blackout checklist. M/S Finneagle Crisis & Alarm Plan (12.5.2015)

Marinersgalaxy (2014), *Black Out on Ship, Recovery and Actions to be taken*

<http://www.marinersgalaxy.com/2014/07/black-out-on-ship-recovery-and-actions.html> (retrieved: 22.4.2015)

ISM Code 2002 edition. IMO (2006), London

Figures

Figure 1:

[http://upload.wikimedia.org/wikipedia/commons/6/66/Standby UPS Diagram SVG.svg](http://upload.wikimedia.org/wikipedia/commons/6/66/Standby_UPS_Diagram_SVG.svg) (retrieved: 27.2.2015)

Figure 2: Engine room blackout checklist. Source kept unnamed. (15.4.2015)

Figure 3: Number of reported blackouts in the Finnish VTS/GOFREP-area 2011-2014, Finnish Transport Agency, senior inspector Kati Westerlund, (7.4.2015)

Figure 4: Promotional photo received from VTS shift supervisor Joonatan Ahlroos (22.4.2015)

Figure 5:

http://www.hafen-hamburg.de/images/image_cache/images/0/fotos/schiffe/9288045_0.jpg (retrieved: 26.1.2016)

Figure 6: Promotional photo received from Aboa Mare Quality Manager Bo Lindroos (27.1.2016)

Appendices

Appendix 1: Simulator exercise datasheet

Datasheet		Group code: _____
1. Background of group members		
	Member 1	Member 2
COC	_____	_____
Seadays	_____	_____
Class	_____	_____
Role	_____	_____
2. Briefing to simulation		
<i>Group A + B</i>		
<ul style="list-style-type: none"> • Check that all controls are set to default! • Ships specifics + ship name + loading condition (full) • Radar + ECDIS • KaMeWa • Logbook • Navigational lights • Override tiller -> as emergency steering • Bow thrusters • Anchoring (calling watchman) • Communication: UHF (watchman) ch: _____, VHF (VTS + other vessels) ch: _____, internal phone (engine room) number: _____ • Inform the group that they are leaving from Loviisa and they must maintain full speed in order to keep up with the schedule • Location (VTS area) and route plan 		
<i>Group B only</i>		
<ul style="list-style-type: none"> • Check-lists: fire, SAR, blackout, MOB 		

3. Actions of the bridge team		
	YES	NO
PRIOR BLACKOUT		
1) Follow planned course and speed	—	—
2) Did the group realize right away what the situation was?	—	—
AFTER BLACKOUT		
1) Inform VTS	—	—
2) Write down time and position	—	—
3) Set lever to zero position	—	—
4) Inform watchman	—	—
5) Use of emergency steering	—	—
6) Use of anchor	—	—
i) which side: _____		
ii) chain length: _____		
iii) did anchor chain brake?	—	—
7) Use secondary anchor if necessary	—	—
8) NUC signal	—	—
9) Inform (final) situation to VTS	—	—
10) Was the checklist used?	—	—
OUTCOME OF THE BLACKOUT		
1. Grounding?	—	—
2. Outside fairway?	—	—
3. Anchored?	—	—
4. Collision?	—	—
5. Drifting?	—	—
6. Abandon ship?	—	—

Appendix 2: Questionnaire

Questionnaire (anonymous)

Give your answers with numerical values from 1 to 10.

1. How challenging did you find the situation?
1=not challenging at all 10=very challenging

2. Do you think that you could have managed better by using a check list (attached)?
1=no difference 10=much better

3. How safe do you think you handled the situation?
1=unsafe 10=safe

4. Are you satisfied with your performance?
1=unsatisfied 10=satisfied

5. Estimate what is the probability that you will encounter a blackout situation onboard in real life during your career.
1=probably not 10=most certainly

6. Free word about the exercise (good/bad, too short/long, was the briefing clear enough)

Appendix 3: Simulator vessel Pilot card

PILOT CARD					
Ship name	LO-RO ship (Dis.19512t) TRANSAS 2.31.41.0 *			Date	11.01.2012
IMO Number	N/A	Call Sign	N/A	Year built	N/A
Load Condition	Full load				
Displacement	19512 tonnes	Draft forward	7.5 m / 24 ft 8 in		
Deadweight	17565 tonnes	Draft forward extreme	7.5 m / 24 ft 8 in		
Capacity		Draft after	8.1 m / 26 ft 7 in		
Air draft	43 m / 141 ft 5 in	Draft after extreme	8.1 m / 26 ft 7 in		

Ship's Particulars			
Length overall	173.5 m	Type of bow	Bulbous
Breadth	23.05 m	Type of stern	Transom
Anchor Chain(Port)	11 shackles		
Anchor Chain(Starboard)	11 shackles		
Anchor Chain(Stern)	N/A shackles	(1 shackle =27.5 m / 15 fathoms)	

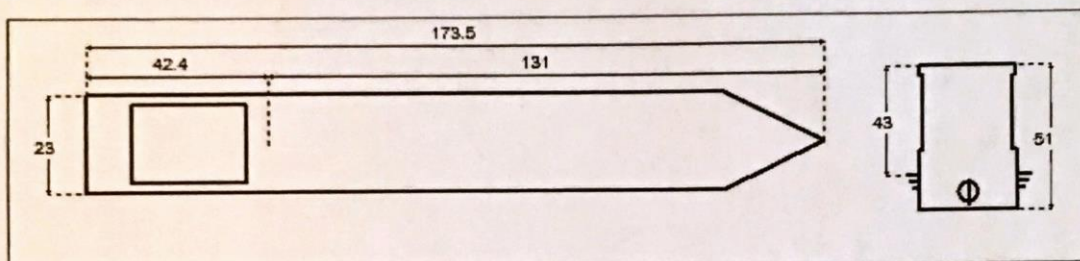

Steering characteristics			
Steering device(s) (type/No.)	Semisuspended / 1	Number of bow thrusters	1
Maximum angle	35	Power	750 kW
Rudder angle for neutral effect	-1.16 degrees	Number of stern thrusters	N/A
Hard over to over(2 pumps)	25 seconds	Power	N/A
Flanking Rudder(s)	0	Auxiliary Steering Device(s)	

Stopping			Turning circle	
Description	Full Time	Head reach	Ordered Engine: 100%, Ordered rudder: 35 degrees	
FAH to FAS	373.6 s	9.55 cbls	Advance	2.79 cbls
HAH to HAS	220.4 s	2.72 cbls	Transfer	1.41 cbls
SAH to SAS	320.6 s	2.91 cbls	Tactical diameter	3.35 cbls

Main Engine(s)			
Type of Main Engine	Slow speed diesel	Number of propellers	1
Number of Main Engine(s)	1	Propeller rotation	Left
Maximum power per shaft	1 x 9540 kW	Propeller type	CPP
Astern power	60 % ahead	Min. RPM	126.94
Time limit astern	N/A	Emergency FAH to FAS	14 seconds

Engine Telegraph Table (Available regimes: ConstRPM/Comby)				
Engine order	Speed, knots	Engine power, kW	RPM	Pitch ratio
100 %	18.2 / 18.1	8590 / 8590	128.3 / 127.7	0.92 / 0.92
80 %	15 / 15.5	5994 / 5994	127.5 / 113.9	0.63 / 0.76
60 %	9.8 / 12.5	4001 / 4001	127.3 / 98.5	0.27 / 0.69
40 %	7.9 / 10.5	2702 / 2702	126.9 / 85	0.18 / 0.64
20 %	5.5 / 7	2303 / 2303	127 / 85	0.11 / 0.31
-20 %	-1.5 / -1.6	1875 / 1875	127 / 85.3	-0.16 / -0.34
-40 %	-2.8 / -3.7	2190 / 2190	127.4 / 85.4	-0.37 / -0.7
-60 %	-4.6 / -5	3310 / 3310	127.3 / 98.4	-0.55 / -0.8
-80 %	-6 / -5.6	5050 / 5050	127.5 / 113.2	-0.74 / -0.88
-100 %	-6.4 / -6.5	7127 / 7127	127.2 / 127	-0.9 / -0.94

Appendix 4: Simulator vessel Wheelhouse poster

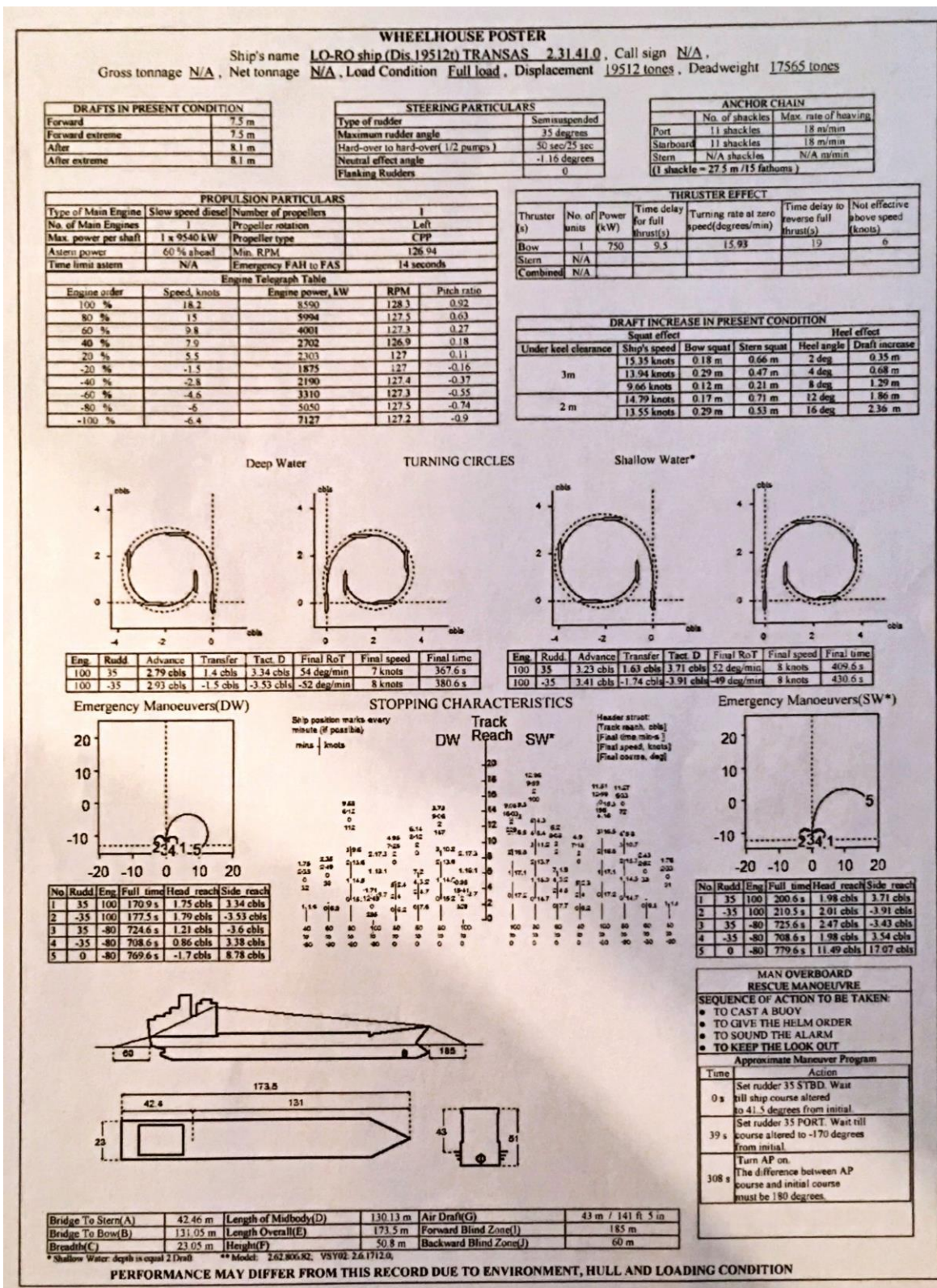

Appendix 5: Blackout checklist for simulator group B members

BLACKOUT CHECKLIST

1. Write down time and position
2. Set KaMeWa lever to zero position
3. Check if the override tiller is working
4. Watchman stand-by to drop anchor
5. Inform VTS and other vessels
6. Find suitable position to drop anchor
7. Signal Not Under Command
8. Inform VTS about the outcome

Appendix 6: Route Plan

LOVIISA - GOFREP										
<i>Wp</i>	<i>Latitude</i>				<i>Longitude</i>		<i>Name</i>	<i>Next wp C</i>	<i>Next wp D</i>	<i>Radius</i>
1	N	60°	24,75'	E	026°	15,71'	Dep. Valko	118°	0,7	1
2	N	60°	24,42'	E	026°	16,94'	Trollholm	175°	1,6	0,3
3	N	60°	22,88'	E	026°	17,18'	Svartholm	157°	3,8	0,6
4	N	60°	19,43'	E	026°	20,20'	Lodgrund	134°	3,6	1,4
5	N	60°	16,93'	E	026°	25,38'	Orregrund	162°	1,4	1,4
6	N	59°	15,58'	E	026°	26,27'	Pilot pos.	203°	4,8	1,4
7	N	59°	11,15'	E	026°	22,48'	GOFREP	N/A	N/A	1,0

Total (nm): 15,9

Appendix 7: Phone numbers

M/S Lo-Ro ship

<u>PHONE NUMBERS</u>		
ENGINE ROOM	phone	102
WATCHMAN	UHF	1
COOK	phone	102
HOSPITAL	phone	102
Kotka VTS	UHF	2