

Saimaa University of Applied Sciences

Technology, Lappeenranta

Double Degree Programme in Construction and Civil Engineering

Shadrina Ekaterina

CHALLENGES OF STRUCTURAL DESIGN OF INDUSTRIAL BUILDINGS ACCORDING TO THE USA REGULATIONS

Thesis 2017

Abstract

Shadrina Ekaterina

Challenges of structural design of industrial buildings according to the USA regulations, 97 pages, 1 appendix

Saimaa University of Applied Sciences, Lappeenranta

Technology, Double Degree Programme in Civil and Construction Engineering
Bachelor's Thesis 2017

Instructors: Lecturer Mr. Heikki Vehmas, Saimaa University of Applied Sciences, Lecturer Ms. Kirsi Taivalantti, Saimaa University of Applied Sciences, Mr. Pekka Narinen, Pöyry Finland Oy, Managing Director Mr. Aleksi Pöyhönen, Pöyry Finland Oy, Managing Director Mr. Robert Wolofsky, Pöyry Montreal Inc., Ms. Victoria Sulina, Pöyry Finland Oy.

This study was commissioned by Pöyry Finland Oy. The purpose of the study was to introduce aspects to be considered during the design of industrial buildings in the United States, to define the difficulties to be faced, to study the main types of solutions and design programs in order to show the design features common in the United States.

In addition, this study is focused on the audience interested in broadening their horizons and seeing the world from designing from another continent.

The topic was selected and coordinated with the assistance of the Head of the construction department, which is the evidence of the construction department interest in this research.

The first part of the thesis is dedicated to the study of the normative documentation, the system of measurement units and the basic methods of calculation.

The second part of the thesis covers the method of load application design, typical solutions and examples of calculations of external loads.

The last part of the study includes typical softwares, typical solutions for floors and exterior walls. This part is also focused on the organization of the construction process within the United States.

As a result of this study, several significant points were identified which could complicate the design process of industrial buildings in the United States.

Keywords: Steel structure design USA, regulations, load combinations

CONTENTS

1 INTRODUCTION	5
2 NORMS AND STANDARDS	8
2.1 General information	8
2.2 Zoning action of norms	9
2.3 Organizations for developing the standards	11
2.4 Point of standardization in the USA	12
2.5 The main standard regulations and codes	12
3 MEASURING SYSTEM	16
3.1 In general.....	16
3.2 How the difference in measurement systems affects in real life	17
4 STRUCTURAL AND FRAME SOLUTIONS	20
4.1 Designer main tasks	20
4.2 Features of designing an industrial building in the United States	21
4.3 The value of the framework in general.....	22
4.4 Fire Protection Techniques for Steel.....	23
4.5 Steel structures as an advantageous option.....	26
4.6 Foundations.....	28
4.7 Columns	32
4.8 Steel beams standards	33
4.9 Bracing	36
4.10 Trusses.....	39
4.11 Corrosion protection	40
5 LOADS.....	42
5.1 Classification of loads	42
5.2 The main provisions of the Allowable Stress Design	43
5.3 The main provisions of the Load Resistance Factor Design.....	45
5.4 Loading combinations.....	47
5.5 Load and Resistance Factor Design.....	48
5.6 Allowable Strength Design.....	49
6 REQUIREMENTS FOR STRUCTURAL ELEMENTS	50
6.1 Deflections and displacements	50
6.2 Structural design loads	50
6.2.1 General.....	50
6.2.2 Dead load	53
6.2.3 Wind load	55
6.2.4. Snow load.....	60
Figure 6.7. Shape coefficients for the following types of roofs according to EN 1991-1-3.....	64
6.2.5. Seismic load	64
6.2.6. Site Soil Classification (for the calculation of foundations)	66
7 DEPENDENCE OF TYPICAL SOLUTIONS ON CLIMATIC ZONES OF THE USA	67
7.1 General.....	67
7.1.1 Weather in the USA: Climate.....	67
7.1.2 Weather in the USA: Types of climate.....	67
7.2 Wall design according to the climate zone.....	69
7.2.1 Wall structure for all climate types.....	69

7.2.2 Hot climate (Zones 1, 2 and 3)	69
7.2.3 Cold climate (Zones 5 to 8)	70
7.2.4 Mixed climate (Zones 3 and 4)	71
7.3 Insulated metal panel wall assemblies.....	75
7.3.1 Field-assembled wall panels	75
7.3.2 Factory-formed metal panels.....	76
8 DRAWINGS	78
9 MOST POPULAR PROGRAMS IN THE UNITED STATES FOR THE DESIGN OF INDUSTRIAL BUILDINGS	80
9.1 S-frame.....	80
9.2 Tekla Tedds 2016.....	80
9.3 Limcon	81
9.4 SPMat.....	82
9.5 SAP2000	84
10 PROJECT AT SITE.....	87
CONCLUSION	90
FIGURES	92
TABLES	94
REFERENCES	95

APPENDICES

APPENDIX 1 So why is America still your other standard?

1 INTRODUCTION

Currently, there are many design companies around the world. Each of them has been trying to develop and occupy a certain niche in the world in the midst of great competition. When a company gets world fame, its projects become recognized all around the world and new offers strew from local and international clients.

After all, it is important for a prosperous company to be successful not only in a local region, but to be in demand abroad as well.

The client of the current thesis is Pöyry Finland Oy, which is an international structural engineering company. The assignments of the company cover all areas of structural engineering. The company has wide experience in operation within Finland, Europe, Russia, the USA and other countries.

The company has enormous experience in conducting their projects in Finland and in many other countries worldwide. Local engineers have experience in industrial design as well as in design of residential and commercial buildings.

In this thesis, the features of the international design of a building in the United States will be considered. When the study began the building had been designed to a great extent. One of the most complex features of this project was the consideration of the US standards in the field of industrial construction.

General issues encountered during participation in the project were: calculations and technical solutions based on international design, preferences in accordance with local practice, and the choice of material that depends on climatic conditions.

Hereinafter, two main objectives of the structure design in accordance with the experience gained will be considered:

- to provide sufficient bearing capacity
- to provide cost-effective solutions

It is very important to design a frame structure which will be safe for the whole lifecycle of a building. In order to guarantee the stability of the structure from the construction phase to the removal from operation in the expiration of the maintenance period, there is a condition that must be fulfilled for each component of a structure:

- Effects of actions < Resistance

During design, it is necessary to pay attention to loads applied. The most challenging aspect for a designer is the ability to define load combinations of interest. If one applies too many loads, then the system will be too heavy and uneconomical. If one applies an insufficient number of loads, the system will be unsafe.

Taking back to history the Babylonian King Hammurabi adopted the concept of safety, about 4000 years ago. He imposed on the builders a law of retribution, and the penalty was proportional to the social class of the members of the parties concerned. In this code, which is the first important example of contract law, it was prescribed (16):

- If a builder builds a house for someone and completes it, he shall give him a fee of two shekels in money for each sar of the surface (16, rule 228).
- If a builder builds a house for someone and does not construct it properly, and the house that he built fall in and kill its owner, then that builder shall be put to death (16, rule 229).
- If it kills the son of the owner the son of that builder shall be put to death (16, rule 230).
- If it kills a slave of the owner, then he shall pay slave for slave to the owner of the house (16, rule 231)

It is important to note the attention given to the concept of durability by this very old code: “even then it was assumed that a fundamental requirement of the construction was no damage should occur during its entire life” (16).

About two centuries ago, Napoleon Bonaparte presented the concept of responsibility entrusted to the first decade of construction. In addition to the builder, it also required the presence of a specialist (for example, a designer) who shared all the responsibilities and, ultimately, the prison, in the event of a crash or damage within a decade after the structure was put into operation.

As for international projects, there is a great responsibility on the shoulders of a designer. This thesis considers some of the difficulties faced by design companies from the US office.

2 NORMS AND STANDARDS

2.1 General information

The norms of building design provide a necessary base for project development and are of great importance for improving the quality of design and creation of cost-effective projects.

At the beginning, building regulations and standardization in the US were heavily influenced by the building norms of England.

Originally, construction standards in the United States were established for certain requirements for the types of houses, the place of their construction and roofing. It all began with the fact that the authorities of cities and states began to study the possibility of developing technical documents taking into account the real practice of construction. They also engaged in the development of basic provisions for the development of settlement plans, the establishment of gaps between buildings, ensuring the strength and reliability of building structures and normal living and working conditions citizens.

The history of the first building code started in the 1927 year. International Conference of Building Officials published the Uniform Building Code, which was based in Whittier, California. Its main difference, from previous standards, is the standardization of requirements for safe construction and assistance with public safety, regardless of the city. Previously, the norms depended on territorial application.

In 2000, UBC was replaced by a new International Building Code (IBC). IBC was published by the International Code Council (ICC), which was a union of three predecessors. Their predecessors published three different building codes. These were:

- NBC (National Building Code), developer - Building Officials and Code Administrators International (BOCA);
- SBC (Standard Building Code), developer - Southern Building Code Congress International (SBCCI);

- UBC (Uniform Building Code), developer - International Conference of Building Officials (ICBO).

The new ICC was intended to provide consistent standards for safe construction and eliminate differences between the three different predecessor codes.

The current norms of the IBC-2009 ICC include the main provisions of all earlier American standards, but they add new requirements for taking into account seismic and wind effects, improving thermal insulation, etc.

Along with the above documents, municipal building codes have become quite widespread in the US. They are usually found in large cities with historically established normative base, which is supported and developed by local scientific and design organizations, but financed by local authorities. Examples of such norms are the Building Code of New York, the United Building Code of San Francisco.

2.2 Zoning action of norms

In the US up to the end of the last century the following basic building codes operated, covering all types of buildings and structures (from simple canopies for storage to multi-store office buildings or sports complexes):

- NBC (National Building Code);
- SBC (Standard Building Code);
- UBC (Uniform Building Code).

Developers of these norms (the main norm-setting organizations of the United States) had been competing for a long time among themselves in order to have a right to adapt these norms by state and local authorities. In reality, however, the three codes are regional in nature, as indicated in Figure 2.1. For example, NBC norms have historically been developed for the conditions of the north-eastern US states, where seasonal freezing of base soils takes place. SBC rates were more often used in those southeastern states where hurricanes are observed, and UBC rates are in the western half of the US, where earthquakes are possible.

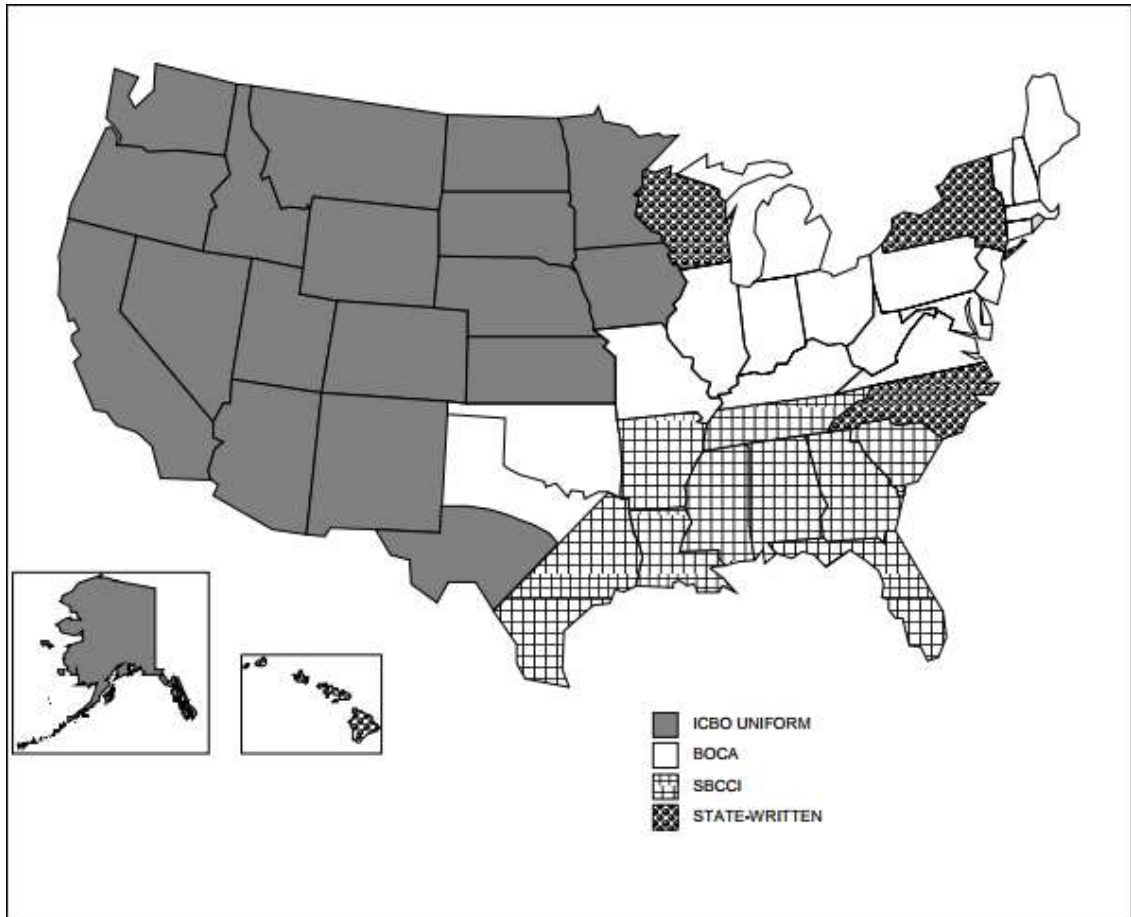

Figure 2.1. Use of Model Building Codes in the United States (21, p. 1-12)

US building codes do not contain detailed specifications for building materials and products. They rely on industry standards and above all on the standards of the American Society for Testing and Materials (ASTM).

There is a number of ASTM standards for the testing, classification and certification of wooden structures, as well as other structures of concrete, masonry and steel. Currently, building codes used in the US refer to ASTM standards.

Building materials that are recognized, but not reflected in the norms or standards, are dedicated to special assessment reports. They are usually developed by specialized and law-making organizations on a commercial basis, commissioned by the manufacturers of materials. In the United States, the National Evaluation Service, Inc. (NES) evaluates the materials used in the basic building codes.

It is important to note that the basis for standardization in the US - regardless of the level and scope of the standards being developed - is the so-called voluntary standardization.

2.3 Organizations for developing the standards

In the United States, the following organizations are in charge of standards development:

- American National Standards Institute (ANSI);
- National Institute of Standards, Technology and Technology (NIST);
- American Society for Testing and Materials (ASTM);
- National Fire Protection Association (NFPA);
- American Institute of Steel Structures (AISC);
- American Concrete Institute (ACI);
- American Institute of Architects (AIA);
- American Society of Civil Engineering (ASCE);
- American Society of Plumbing Engineers (ASPE);
- The National Association of Home Builders (NAHB) and etc.

Despite of the voluntariness of the nature of standardization and the optional nature of most standards, their impact is crucial, since the violation of certain standards practically leads to loss of customers or difficulties with the sale of products.

In addition, "non-mandatory" standards actually become mandatory, but not through administrative approval, but with reference to applicable standards in contract texts and the inclusion in building code standards of standards lists. That is why construction products in the United States are produced by standards.

2.4 Point of standardization in the USA

First of all, this is considered a prerequisite for scientific and technological progress. The adaption of standards is based on economic assessments to ensure production efficiency, reduce costs and improve quality.

The insurance system has its great influence in the development of building codes. In practice, however, a firm or forecaster cannot follow certain standards prepared by insurance companies and approved by the National Institute of Standards, Technology and Technology. If the forerunner refuses to adhere to these agreements, the risk increases and the insured amounts decrease accordingly.

Their compliance with the design, manufacture and use of materials, structures, parts and objects in general allows the creation of reliable, durable and safe buildings and structures and at the same time ensures the rational use of material, labor and energy costs.

Thus, the dynamic structure of standardization and technical regulation in construction has long been established and is developing in the United States. It is important to realize necessity of special documents, which completely outline the main requirements at the modern scientific and technical level.

With such a combination of the design process in the future use of materials in detail designs allows you to create reliable, safe in operation and durable buildings and structures. With such a successful use of materials, energy and labor costs, the full rationality of the construction process is ensured.

2.5 The main standard regulations and codes

General requirements for rolled structural steel plates, bars, sheet piling and shapes are presented in the ASTM A6 (Standard Specification for General Requirements for Rolled Structural Steel Bars, Plates, Shapes and Sheet Piling).

The main specification to apply for the design of steel structures in the United States is ANSI/AISC 360-16 'Specification for Structural Steel Buildings' that addresses steel constructions as well as composite constructions: steel acting compositely with reinforced concrete. This specification states design require-

ments (stability and strength) for steel members and composite constructions, design of connections, fabrication and erection, Quality Control and Quality Assurance.

ACI 301-16 'Specification for Structural Concrete' covers materials and proportioning of concrete; reinforcement and prestressing steel; production, placing, finishing, and curing of concrete; formwork performance criteria and construction; treatment of joints; embedded items; repair of surface defects; and finishing of formed and unformed surfaces. Provisions governing testing, evaluation, and acceptance of concrete as well as acceptance of the structures are included.

ACI 318/318R-14 'Building Code Requirements for Structural Concrete and Commentary' provides minimum requirements for the materials, design, and detailing of structural concrete buildings and, where applicable, non-building structures. A non-building structure is also referred to a structure or system of connected parts used to support a load that was not designed for continuous human occupancy. Non-building structures include all self-supporting structures which carry gravity loads, with the exception of buildings, vehicular and railroad bridges, electric power substation equipment, overhead power line support structures, buried pipelines, conduits and tunnels, lifeline systems, nuclear power generation plants, offshore platforms, and dams (26, chapter 14).

This Code addresses structural systems, members, and connections, including cast-in-place, precast, plain, nonprestressed, prestressed, and composite construction. Among the subjects covered are design and construction for strength, serviceability, and durability; load combinations, load factors, and strength reduction factors; structural analysis methods; deflection limits; mechanical and adhesive anchoring to concrete; development and splicing of reinforcement; construction document information; field inspection and testing; and methods to evaluate the strength of existing structures.

ASCE 37-02 'Loads during Construction' provides minimum design load requirements during construction for buildings and other structures. It addresses partially completed structures and temporary structures used during construc-

tion. The loads specified are suitable for use either with strength design (such as USD and LRFD) or with allowable stress design (ASD) criteria.

ANSI/AISC 341-16 'Seismic Provisions for Structural Steel Buildings' and ANSI/AISC 358-16 'Prequalified Connections for Special and Intermediate Steel Moment Frames for Seismic Applications' cover the seismic resistance of the structures. ANSI/AISC 341-16 provides additional rules for the design and production of steel structure that will be used in seismic zones. ANSI/AISC 358-16 provides design methods for designing connections that will be used in earthquake resistant structures.

Finally, AISC 303-16 'Code of Standard Practice for Steel Buildings and Bridges' addresses design, purchase, fabrication and erection of structural steel.

Very useful tools for the designer are the AISC manuals: the AISC 325 Steel Construction Manual and the AISC 327 Seismic Design Manual. They give many examples that can help in the designing.

Required strength (RS) has to be less or equal to the design strength (LRFD) or allowable strength (ASD) and has to be computed for appropriate loading combinations. RS assumes different values if evaluated in accordance with LRFD or with ASD.

Actually, ASCE/SEI 7-10 document (Minimum Design Loads for Buildings and Other Structures) proposes two different sets of loading combinations for the two methods.

Figures 2.2 and 2.3 depict printed publications of normative publications.

In practice, knowledge of normative documentation is necessary for designing any field of activity. Over time, if you start to study and design according to the norms of the United States, the result will be the same as in the design for Eurocodes. However, if you take a project, without having any knowledge in the field of regulatory documentation, you can form big problems. Each code has its own specifics, which you can learn after a long and diligent study. The task will be much simpler if the company has an office in the United States or Canada. Specialists there have a huge experience in designing by standards, and are familiar with the basic design solutions.

Working drawings (construction documents and specifications) are developed by architectural / engineering consulting companies. The goal is to develop a design that satisfies the customer, obtain a building permit, pass the examination in the "examination" and develop a legal document - "contract" which would indicate that a contractor shall build an object by means of customer's funds. Shop drawings - drawings of the assembly - detailed drawings of any specialty. Usually a consulting company requires these drawings for approval (the project specifies which drawings the contractor must submit for approval to the design organization) and only after approval, stamp and signature these drawings to go into operation.

First step to become a licensed engineer in the USA - complete a four-year college degree. Second one is to work under a Professional Engineer for at least four years. After that an engineer has to pass two intensive competency exams and to earn a license from State's licensure Board. Then, to retain their licenses, PEs must continually maintain and improve their skills throughout their careers. Licensure for engineers in government has become increasingly significant. In many federal, state, and municipal agencies, certain governmental engineering positions, particularly those considered as higher level and responsible positions, must be filled by licensed professional engineers. Only a licensed engineer may prepare, sign and seal, and submit engineering plans and drawings to a public authority for approval, or seal engineering work for public and private clients.(38)



Figure 2.2. ANSI/AISC 360-16



Figure 2.3. ASCE/SEI 7-16

3 MEASURING SYSTEM

3.1 In general

“You, in this country are subjected to the British insularity in weights and measures; you use foot, inch and yard. I am obliged to use that system, but must apologize to you doing so, because it is so inconvenient, and I hope Americans will do everything in their power to introduce the French metrical system... I look upon our English system as a wickedly, brain-destroying system of bondage under which we suffer. The reason why we continue to use it, is the imaginary difficulty of making a change, and nothing else; but I do not think in America that any such difficulty should stand in the way of adopting so splendidly useful a reform”

— William Thomson Kelvin

In Journal of the Franklin Institute (1884).

A lot of great people have spoken out about the fact that a different measurement system is adopted in the United States. There are many caricatures on this subject. One of them is shown in Figure 3.1.

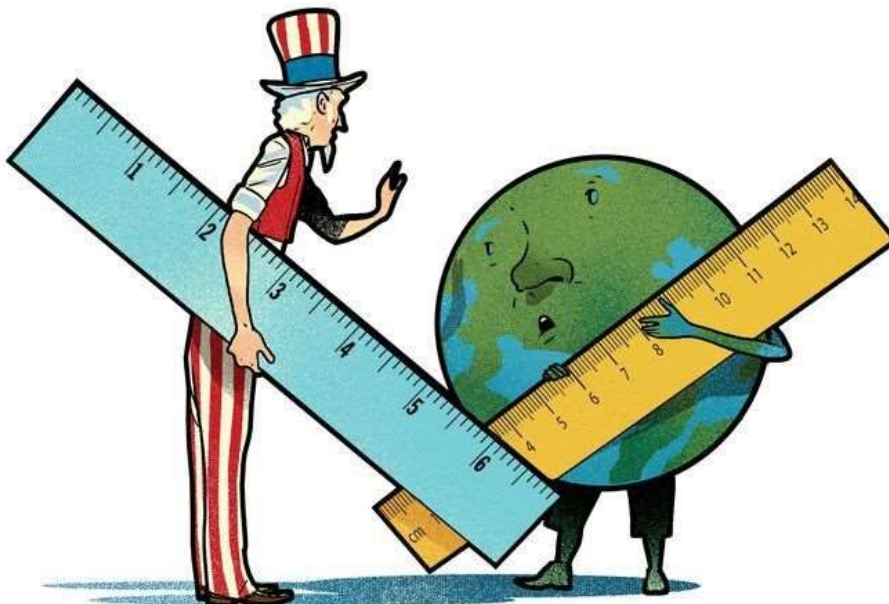

Figure 3.1. The opposition of the system of measuring in the United States to the whole world (39)

There are 2 basic schemes for making measurements of lengths and weights, the Imperial measuring system and the metric complex measuring system. The especially common is the metric system. This scheme is tested worldwide, where people use units like grams and meters, and supplements particles such as kilo, millimeters and centimeters to calculate orders. In the United States, more often people use an elderly imperial system where belongings are estimated in pounds, inches and pounds. At present, the United States is the solely manufactured country in the world that does not enjoy the metric system as its general measurement system.

For each design process, codes have been installed to ensure security in accordance with certain rules and conditions. One hundred and one, each project code is published in accordance with certain criteria, depending on the weather, the properties of building materials in this zone and other circumstances. Thus, the differences must be from the development code to the other. The imperial system is also called the British Emperor. The new US government, after U.S acquired self-sufficiency from the UK, decided to retain this type of measurement, although the metric system at that time became popular.

Instead of the international SI system in the United States, the U.S. Customary System (Traditional US System) has been used. It includes more than three hundred units of measurement of various physical quantities. The difficulty is that many of these units of measurement are called identically, but they mean completely different things.

3.2 How the difference in measurement systems affects in real life

In order to understand how the difference in the units of measurement complicates the work, let us consider one simple and explicit example. In the United States there are at least nine definitions of the term "ton":

- short ton;
- displacement ton;
- refrigeration ton;
- nuclear ton;

- freight ton;
- register ton;
- metric ton;
- assay ton;
- fuel ton;
- ton of coal equivalent.

In addition, despite of all these obvious difficulties, neither in business nor in everyday life of the US a simple, clear and unambiguous metric system is used. The reasons for this lie, as it often happens, in the history of this country.

It is clear that for a European not familiar with inches and feet, the first time is very difficult to adapt. You constantly have to spend time translating units. Nevertheless, it is one thing when it comes to distances, but another thing when it comes to loads. Figure 3.2 shows the translation of the most common measurement units from the American system of measurement. In appendix 1 a more detailed table with an expanded list of values is presented.

The National Institute of Standards and Technology (NIST) is a measurement standards laboratory, and a non-regulatory agency of the United States Department of Commerce. Its mission is to promote innovation and industrial competitiveness.

NIST's activities are organized into laboratory programs that include Nanoscale Science and Technology, Engineering, Information Technology, Neutron Research, Material Measurement, and Physical Measurement.

The National Institute of Standards and Technology published a particular addition 1038. The publication contains recommendations on the use of the International System of Units to assure the use of weights and extents.

If the inch-pound value is expressed by a combination of units such as feet and inches, or pounds and ounces, it should first be converted into the smaller unit.

Examples:

12 feet 5 inches = 149 inches

1 pound 3-1/2 ounces = 19.5 ounces

For example, to convert 10.1 feet to meters multiply by 0.3048:

$$10.1 \text{ feet} \times 0.3048 = 3.07848 \text{ m}$$

At this point it is good practice to keep all of the digits, especially if other mathematical operations or conversions will follow. Rounding should be the last step of the conversion process and should be performed only once.



**United States Department of Commerce
Technology Administration**
National Institute of Standards and Technology
Metric Program, Gaithersburg, MD 20899

METRIC CONVERSION CARD
Approximate Conversions to Metric Measures



<i>Symbol</i>	<i>When You Know</i>	<i>Multiply by</i>	<i>To Find</i>	<i>Symbol</i>
LENGTH				
in	inches	2.5	centimeters	cm
ft	feet	30	centimeters	cm
yd	yards	0.9	meters	m
mi	miles	1.6	kilometers	km
AREA				
in ²	square inches	6.5	square centimeters	cm ²
ft ²	square feet	0.09	square meters	m ²
yd ²	square yards	0.8	square meters	m ²
mi ²	square miles	2.6	square kilometers	km ²
	acres	0.4	hectares	ha
MASS (weight)				
oz	ounces	28	grams	g
lb	pounds	0.45	kilograms	kg
	short tons (2000 lb)	0.9	metric ton	t
VOLUME				
tsp	teaspoons	5	milliliters	mL
Tbsp	tablespoons	15	milliliters	mL
in ³	cubic inches	16	milliliters	mL
fl oz	fluid ounces	30	milliliters	mL
c	cups	0.24	liters	L
pt	pints	0.47	liters	L
qt	quarts	0.95	liters	L
gal	gallons	3.8	liters	L
ft ³	cubic feet	0.03	cubic meters	m ³
yd ³	cubic yards	0.76	cubic meters	m ³
TEMPERATURE (exact)				
°F	degrees Fahrenheit	subtract 32, multiply by 5/9	degrees Celsius	°C

Figure 3.2. Metric conversion card according to NIST (9)

4 STRUCTURAL AND FRAME SOLUTIONS

4.1 Designer main tasks

Design professionals offer a wide range of services to a builder or developer in the areas of land development, environmental impact assessments, geotechnical and foundation engineering, architectural design, structural engineering, and construction monitoring.

In addition, the services of structural designers are usually required:

- when designing large-span ceilings and high-height walls in the presence of large openings or high ceilings;
- to account for extreme loads (for example, from strong winds, seismic impacts, heavy snowfalls or heavy equipment);
- when non-traditional designs or materials are used;
- to take into account unfavorable engineering geological or other local conditions (for example, in the presence of expanding soils, complicated strata of soil with a different bearing capacity, as well as taking into account floods or steep terrain);
- according to the customer's requirements, caused by the need to use special materials and equipment, etc.

Large construction organizations with large amounts of construction and installation work, as a rule, have in their staff of designers. Many construction organizations attract designers as experts or consultants only when necessary. In connection with the expansion of construction in areas prone to natural disasters (for example, with the threat of earthquakes, hurricanes or tornadoes), the demand for design services in the United States is increasing. In some cases, customers attract designers to local inspections and ongoing monitoring of the condition of buildings and structures. Figure 4. shows the organization of the construction department.

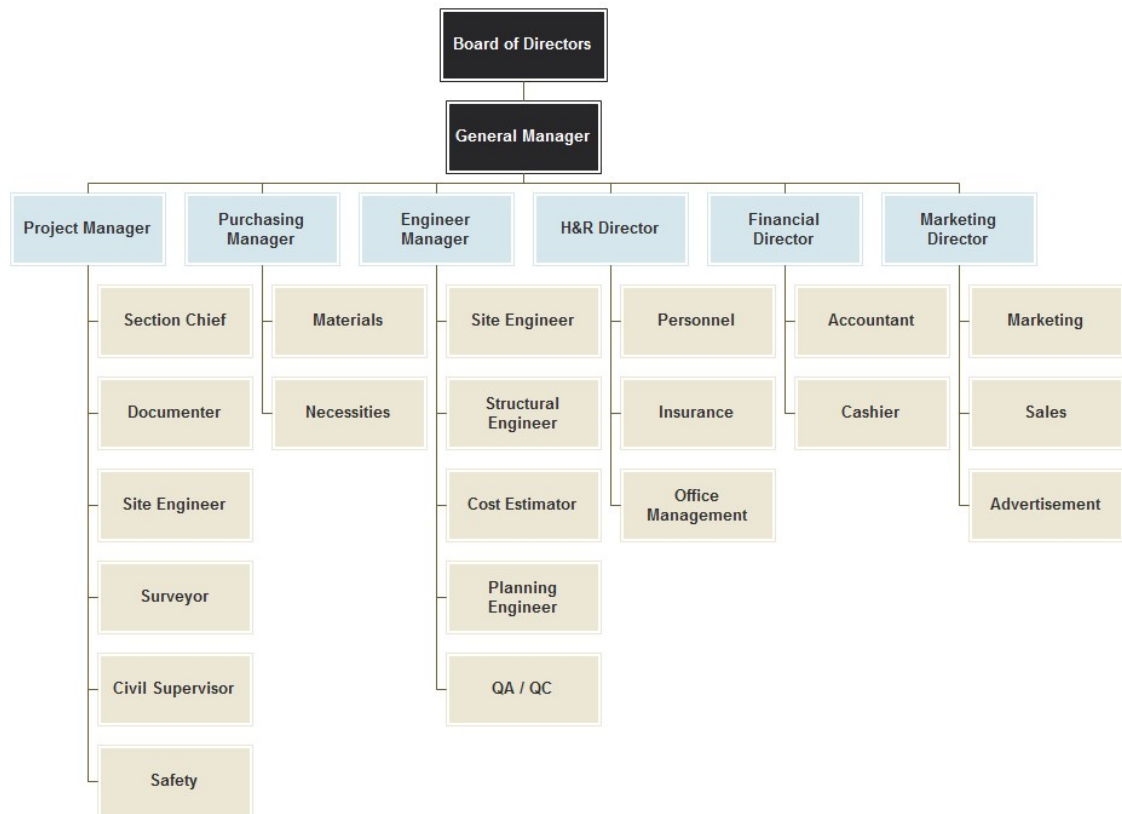

Figure 4. Construction organization chart USA

4.2 Features of designing an industrial building in the United States

Based on the example of an industrial building, the thesis presents aspects a designer faces when designing an industrial building in the United States. During the pre-design of the plant, originally the main material for the bearing frame was chosen reinforced-concrete. Since this design solution is most often used in such buildings.

After meetings with the customer, it was decided to use steel buildings with concrete foundations and concrete slabs for circulation of forklifts or steel platforms for circulation of personnel. If the roof was lightly loaded, structural engineers in the US would use OWSJ (open web steel joist), otherwise purlins and joists. If it is a corrosive environment, the building structures are usually all concrete. In this case the environment was not such.

Industrial buildings - a building system consisting of load-bearing and enclosed or combined structures forming a closed space intended on placing industrial

equipment and providing the necessary conditions for labor of people and operation of technological equipment.

Industrial buildings are used for implementation of any technological process and release of finished products. They are subdivided into the main production halls, auxiliary production or auxiliary shops, power departments, serving to house equipment producing compressed air, steam, electricity, etc. For the execution of technological cycles, industrial buildings are usually equipped with lifting and handling equipment, means of industrial transport, communication facilities, etc. According to the type of structural schemes, industrial buildings are divided into 4 main classes: single-storey buildings, usually used to accommodate heavy equipment, or associated with the manufacture of large-scale products (enterprises of ferrous metallurgy, metalworking, building materials, etc.), single-story pavilion type, in shipbuilding, aircraft construction, etc. .; two-storey, usually multi-span, with warehouses on the first floor, lots with heavy equipment and on the second floor - the main (crowded) production (often with increased requirements for the microclimate); multi-storey buildings are designed for industries that require vertical organization (self-sustaining) technology, as well as for industries equipped with relatively light small-sized equipment (instrumentation, precision engineering, electronics, radio engineering, printing, etc.)

4.3 The value of the framework in general

Enclosing structures protecting the premises from the influence of the external environment, the paths of the internal transport, various platforms, ladders, pipelines and other technological equipment are attached to the frame of the building.

The frame which is a complex of load-bearing structures that perceives and transfers to the foundations the load from the weight of enclosing structures, technological equipment, atmospheric loads and impacts, loads from intra-plant transport (bridge, suspension, cantilever cranes), temperature technological impacts and the like, can be performed from reinforced concrete, mixed (that is, part of the structures - reinforced concrete, part - steel) and steel. The choice of the carcass material is an important technical and economic task.

The steel frame of an industrial building must fully satisfy the purpose of the structure, be reliable, durable and economical.

In industrial buildings, in comparison with others, the influence of production technology on the structural scheme of the frame is most significant, and therefore often the design form is completely determined by the dimensions and arrangement of the equipment, by internal transport, by the way of moving parts and finished products. Technologies for the production of various products are very diverse, and the operational requirements are usually specific, specific for this particular production.

Cranes have an extremely great influence on the work of the building frame. Being dynamic, repetitive and large in size, crane influences often lead to early wear and damage to frame structures, especially crane beams. Therefore, when designing the frame of a building, it is necessary to take into account the mode of operation of bridge cranes, which depends on the purpose of the building and the production process in it.

The operating mode of the cranes and the type of cargo suspension are taken into account in the design of the frames. For example, with cranes of very heavy duty, greater lateral and longitudinal rigidity of the frames, greater reliability and endurance of the crane beams should be provided.

In this regard, before the design of frame buildings should begin, exhaustive data on transport equipment should be obtained and the number of loading cycles of structures for the standard period of their operation (load cycle - change of voltage from zero through maximum to zero) is calculated. For the number of cycles for crane constructions, it is possible to take the number of lifts for the service life.

4.4 Fire Protection Techniques for Steel

Given the significant reduction in the mechanical properties of steel at temperatures on the order of 540 °C (1,000 °F), isolated and unprotected steel members subjected to the standard test-heating environment are only able to maintain their structural integrity for 10 to 20 minutes, depending on the mass and size of the structural member. Unprotected open web steel joists supporting concrete

floors in the ASTM E119 fire test have been tested and collapse in 7 minutes (34). Isolated and unprotected steel box columns 8 inches x 6 1/2 inches formed using 1/4-inch plate and channels in an ASTM E119 fire test collapse in about 14 minutes (35). Consequently, measures are taken to protect loadbearing, steel structural members where the members are part of fire resistant assemblies. A variety of methods are available to limit the temperature rise of steel structural members, including the insulation method and the capacitive method.

Insulation Method: The insulation method consists of attaching insulating spray-applied materials, board materials, or blankets to the external surface of the steel member. A variety of insulating materials have been used following this method of protection, including mineral-fiber or cementitious spray-applied materials, gypsum wallboard, asbestos, intumescent coatings, Portland cement concrete, Portland cement plaster, ceramic tiles, and masonry materials. The insulation may be sprayed directly onto the member being protected, such as is commonly done for steel columns, beams, or open web steel joists. The spray-applied mineral fiber, fire resistive coating is a factory mixed product consisting of manufactured inorganic fibers, proprietary cement-type binders, and other additives in low concentrations to promote wetting, set, and dust control. Air setting, hydraulic setting, and ceramic setting binders can be used in varying quantities and combinations or singly, depending on the particular application.

Alternatively, the insulation may be used to form a “membrane” around the structural member, in which case a fire resistive barrier is placed between a potential fire source and the steel member. An example of membrane protection is a suspended ceiling positioned below open web steel joists. (In order for a suspended ceiling assembly to perform effectively as a membrane form of protection, it must remain in place despite the fire exposure. Only some suspended ceiling assemblies have this capability.) In most of the WTC complex buildings and tall buildings built over the last 50 years, the preferred method has been spray-applied mineral fiber or cementitious materials. Of these 50 years, for the first 20 years the product contained asbestos and for the last 30 years it has been asbestos free. The WTC 1, 2, and 7 incidents are the first known collapses of fire resisting steel frame buildings protected with this type of fireproofing

material. Occasionally, a portion of the steel is protected with a spray or trowel applied plaster or Portland cement (e.g., Gunitite or shotcrete).

Capacitive Method: The capacitive heat sink method is based on the principle of using the heat capacity of a protective material to absorb heat. In this case, the supplementing material absorbs the heat as it enters the steel and acts as a heat sink. Common examples include concrete filled hollow steel columns and water filled hollow steel columns (35). In addition, a concrete floor slab may act as a heat sink to reduce the temperature of a supporting beam or open web steel joist.

The work and longevity of building structures is greatly influenced by the internal environment. The degree of aggressive influence of the internal shop environment on steel structures is determined by the rate of corrosion damage to the unprotected surface of the metal, mm / year. Depending on the concentration of corrosive gases and relative humidity, four degrees of aggressiveness of the medium for steel structures are established: non-aggressive (corrosion rate of unprotected metal to 0.01 mm / year), weak (up to 0.15 mm / year), medium (up to 0.1 mm / year) and strong (over 0.1 mm / year).

Figures 4.1, 4.2 and 4.3 show examples of typical industrial buildings made using a steel frame. Studying industrial buildings in the United States, it was also found out that most of them are made of steel.



Figure 4.1. Gilbert smith forest products



Figure 4.2. Babine forest products



Figure 4.3. Old steel frame building in the US (40)

4.5 Steel structures as an advantageous option

Why is steel construction preferred? Main issues are:

- It is quicker to install and because you do not have cure times, formwork, etc. to consider compared with a concrete structure
- The other benefit is that steel can be erected in winter, whereas pouring concrete in the winter has its own challenges (such as temporarily heating the entire structure)
- Prices for steel company stocks are dropping, so it is not surprising that there is a question as to whether steel is still an ideal material for construction projects
- Steel companies are trying to weather the economic storm just like other businesses, and less construction means fewer production jobs
- Since steel is the main material, there is much more choice among subcontractors in construction, which reduces the cost of building the entire building
- Reduction in the number of mounting elements;

- Minimization of the volume of aggregate assembly at the construction site due to the enlargement of the shipping elements;
- Transportability of structural elements;
- Simplifying the mounting interface of elements;
- Necessary rigidity of the elements during transportation and installation of the metal frame;
- Reduction of design time.

Unification of space-planning and constructive solutions allows to dramatically reduce the number of standard sizes of structural elements of building frames and opens the possibility of developing standard designs for multiple applications.

Sometimes the client has a preference on all concrete anyways but the majority of buildings are steel with girts/steel siding and roof decking for a built-up roof.

There are also requirements for fire protection. Since the building is industrial there is a great risk of a fire.

If there will be a project of the designing of the turbine, for instance, engineers would generally have a fire suppression sprinkler system in place to quench fires and limit flame spread.

FM global is the major insurer of these types of buildings and they usually give guidance on the fire systems. For instance, the roof compositions need to be rated for a certain class of fire resistance to limit spread of flames.

Columns sometimes need to be sprayed with fire resistant foam to avoid collapse of the roof and the building. They would also specify fire rated walls (such as an 8" freestanding block wall) or fire resistant walls (1-hr siding composition) to limit spread of fires to other buildings.

Also note that US electrical rooms are always fire rated walls with slabs for the roof (usually 2-hr rated) so that any fire started in the electrical room can be "contained".

Even though we do use steel frames for the industrial buildings, fire is very much an important aspect in our designs for the buildings as a whole. Architects are usually the ones that review these items in the USA.

4.6 Foundations

The foundation is the most important part of a steel building of the prefabricated structure and a part that over time can cause problems to the superstructure. Consolation cellars, unsettled or sliding walls and possible structural damage can be a result of poor foundation.

Types of foundations:

- Plate foundation (or floating foundations) are concrete slabs with a continuous beam. Propagating directly under the column or strengthening along the bottom, cylinders of continuous quality carry a vertical load of the columns.
- Pier, footing and beam class consist of a square or rectangular support and a class beam wall. Instead of a square or rectangular support, a drill pier can be used. Piers and supports bear most of the vertical loads.

General requirements in the existing regulatory documents for the design of foundations:

- ensuring the strength and operational parameters of buildings and structures (general and non-uniform deformations should not exceed permissible values);
- maximum use of strength and deformation properties of the foundation soils, as well as the strength of the foundation material;
- achievement of minimum cost, material consumption and labor intensity, shortening of construction time.

Compliance with these provisions is based on the following conditions:

- Comprehensive accounting when choosing the type of foundations and foundations of engineering-geological and hydro-geological conditions of the construction site;

- taking into account the influence of structural and technological features of the structure on its sensitivity to uneven precipitation;
- the optimal choice of methods for performing work on the preparation of foundations, the installation of foundations and the underground part of structures;
- calculation and design of foundations, taking into account the joint work of the system "footing - foundations - structure construction".

Thus, the design of foundations includes selection of the type of foundation (natural or artificial), the constructive solution (including the material) and the dimensions of the foundations (the depth of the embankment, the dimensions of the footprint, etc.). Moreover, it also includes the measures used for reducing the influence of deformations of the foundation on the serviceability and durability of the structure.

Figure 4.4 presents minimum dimensional requirements for foundation based on ACI 332.

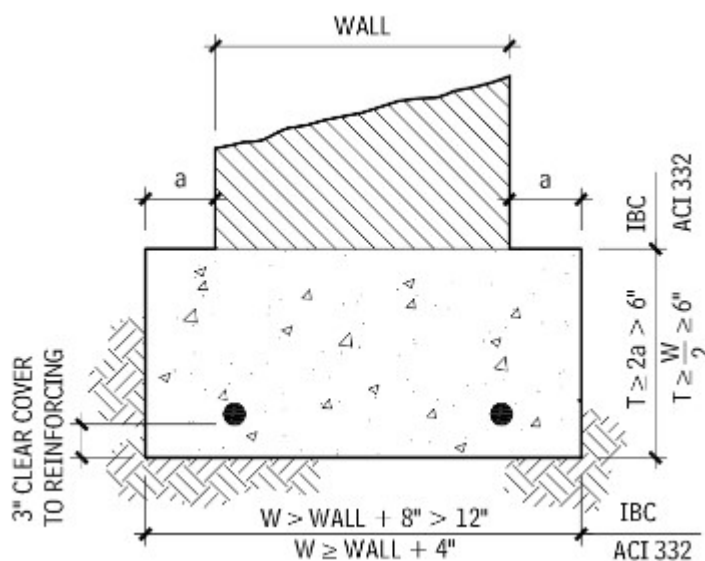

Figure 4.4 Footing minimum dimensional requirements (1, p. 11)

All residential and industrial buildings of a structural type can be divided into two categories - with a frame and without it. In most cases, such a skeleton is equipped for production facilities and therefore columnar foundations for columns (or piles) are mounted for them.

Below, Figure 4.5 shows a typical version of a steel structure with a foundation. It is worth noting that in general the construction is no different from the usual European foundations.

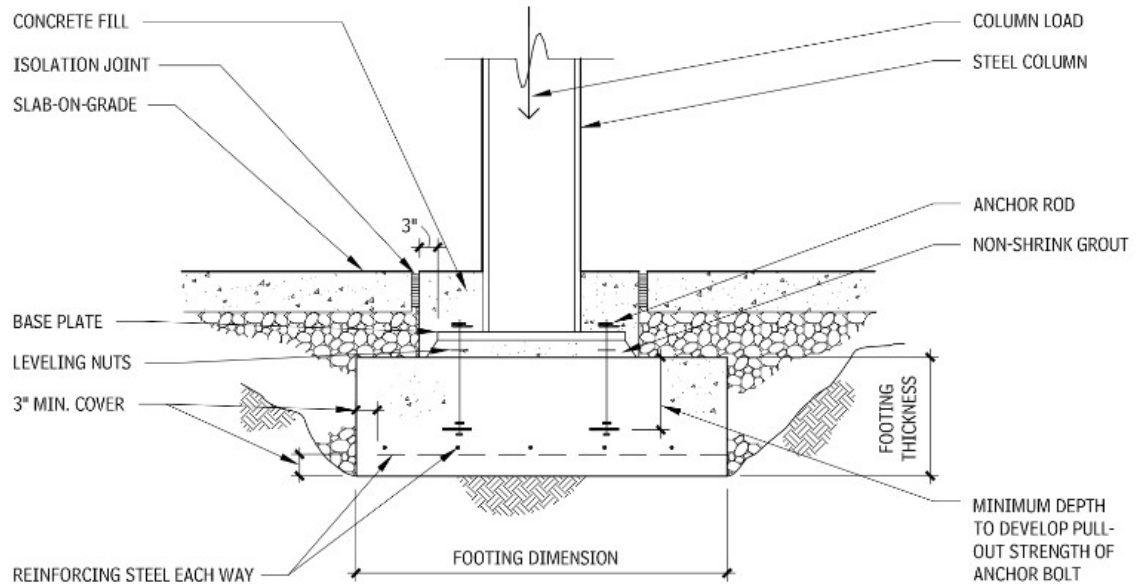

Figure 4.5. Spread footing-steel column (1, p. 12)

The foundations of industrial buildings, with the appropriate technical and economic basis, are arranged with piles. It is recommended for industrial buildings to use progressive types of piles: driven piles (without transverse reinforcement, composite, pyramidal, rhomboid, clavate, pile columns), bored pipes, etc.

The use of piles makes it possible to erect buildings even in particularly difficult conditions: loose soil, high level of groundwater etc. By using piles, harder soil layers can be achieved, which minimizes the negative impact of the above risk factors to increase the reliability and durability of the building. Different types of pile foundations and classification of piles will help you to choose the foundation of a structure. Figures 4.6-4.9 show the examples of the different types of piles.

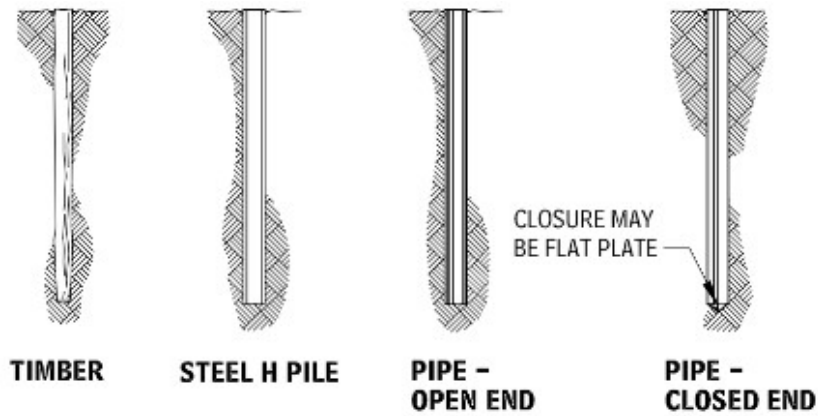

Figure 4.6. Timber and steel piles (1, p. 13)

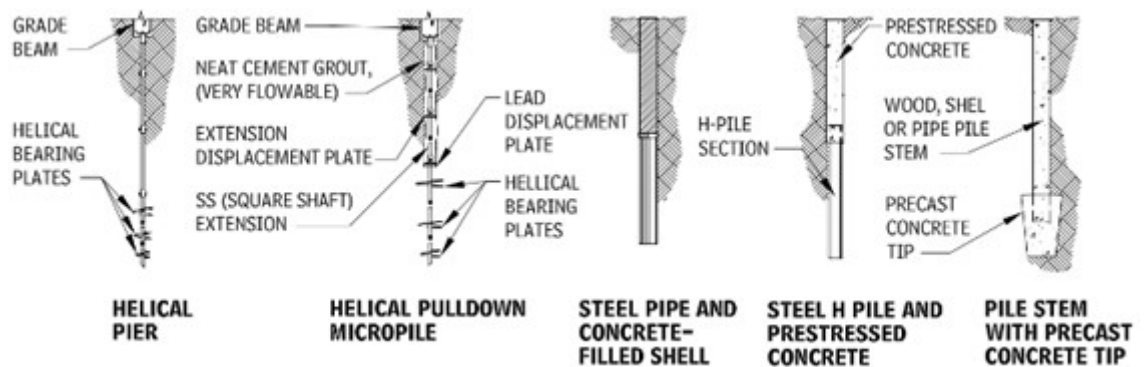

Figure 4.7 Composite piles (1, p. 13)

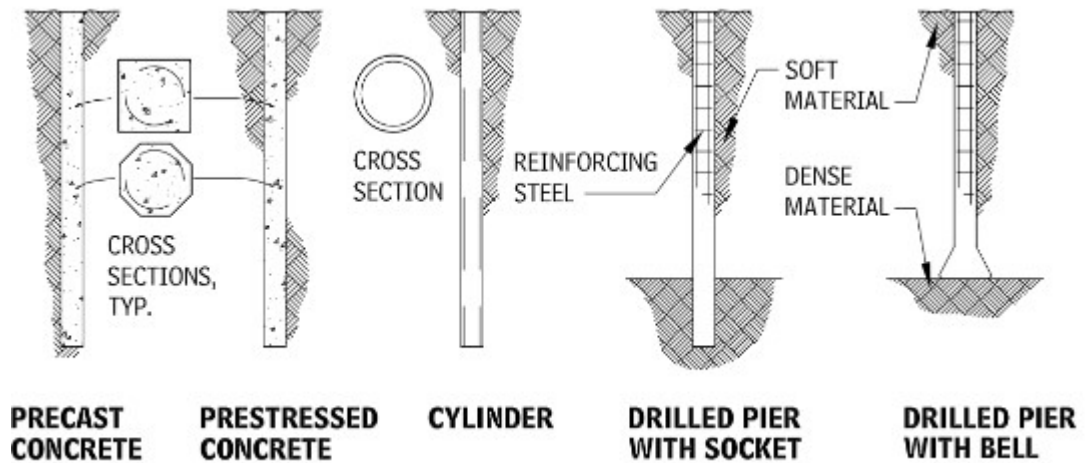

Figure 4.8 Concrete piles part 1 (1, p. 13)

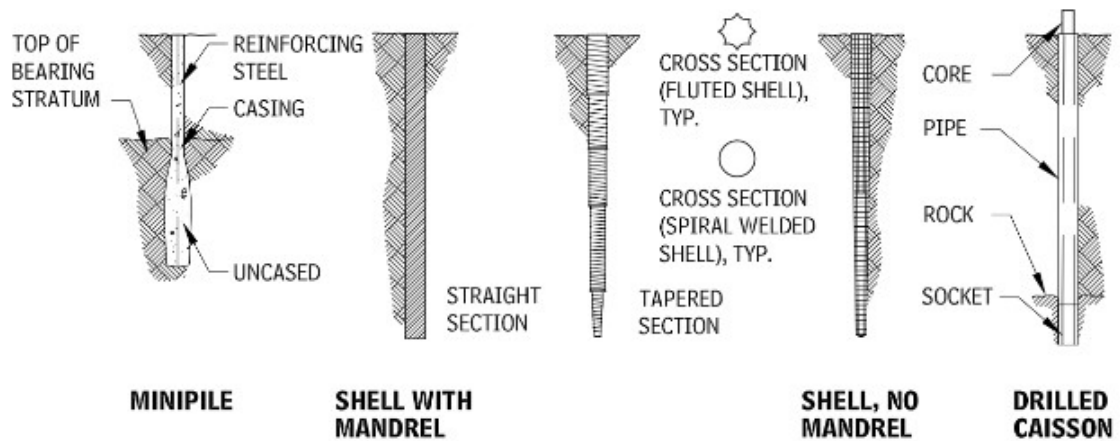

Figure 4.9 Concrete piles part 2 (1, p. 13)

4.7 Columns

Cross-shaped profiles are the most popular steel column profiles. This type - quaternary columns - are made for large spans.

Profile is formed by four corners (Figure 4.10). Due to complete symmetry and peculiar form of the cross-section, this type is often used for aesthetic reasons. For instance it is used for columns that are placed at the intersection of partitions and must be hidden inside them.

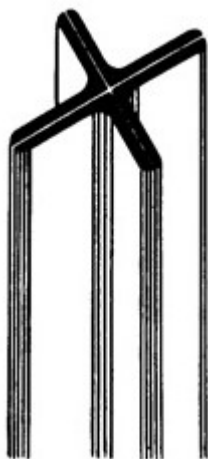

Figure 4.10. Four corners profile (41)

Profiles of the type shown in Figure 4.11, but reinforced with welded steel strips between the corners.

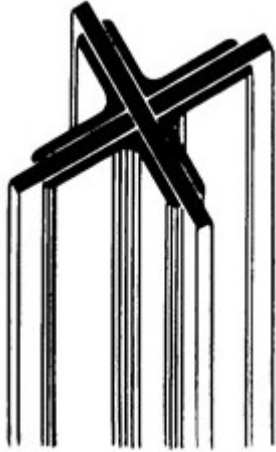

Figure 4.11 Four corners profile with steel strips (41)

Profiles for heavy columns of two W36x150 (W36x135) or sheet steel (Figure 4.12). Such cross-sections are particularly suitable for columns with bending moments in both directions. A combination of different profiles is also often used, such as W30x99 + W36x135.

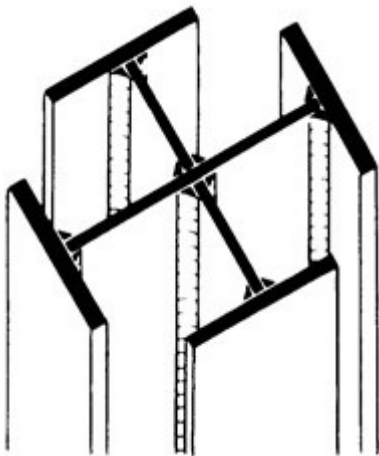

Figure 4.12. Four corners profile (41)

4.8 Steel beams standards

ASTM A6 / A6M - 17 'Standard Specification for General Requirements for Rolled Structural Steel Bars, Plates, Shapes, and Sheet Piling' gives general requirements of this specification to cover a group of technical requirements that, unless stated otherwise in the applicable product specification, apply to rolled bars, sheets, profiles and sheet piles of structural steel subject to each of the following product specifications issued by ASTM.

When faced with the problem of different units, one has to understand that both the load and the profile have to be looked at in terms of units in the head. Another great difference is that in the name of the profile of the I-beam its height and weight are registered. The standard method for specifying the dimensions of a W21x147, this means that its height is approximately 21 in (more specifically 22.1) and the weight is 147 lb / ft.

I-shaped cross-section beams:

Britain: Universal Beams (UB) and Universal Columns (UC)

Europe: IPE. HE. HL. HD and other sections

US: Wide Flange (WF) and H sections

There is another problem with the units of measurement. We have to focus not only on the dimensions, but also on the load. To do this, it will be useful to have a formula at hand for transferring some units of measurement to others.

In table 4.1 six different beam steel profiles are compared. Table 4.2 shows an example of the dimensions of the I-beam adopted in the United States.

Table 4.3 shows an example of the dimensions of the I-beam adopted in Europe.

For ease of translation, you can use the following abbreviations

- $1 \text{ cm}^4 = 10^{-8} \text{ m}^4 = 10^4 \text{ mm}^4$
- $1 \text{ in}^4 = 4.16 \times 10^5 \text{ mm}^4 = 41.6 \text{ cm}^4$
- $1 \text{ cm}^3 = 10^{-6} \text{ m}^3 = 10^3 \text{ mm}^3$

We will make a small comparison of several I-beams. Below in the table there are six beams of pairwise compared. As we see, they have about the same dimensions and weight. Proceeding from this, it can be concluded that there is a unified system for the production of beams, independent of the system for measuring quantities.

Table 4.1: Comparison of I-beams

Designation	Depth (mm)	Width b (mm)	Web thickness t_w (mm)	Flange thickness t_f (mm)	Sectional Area (cm^2)	Weight kg/m
W8x15	206	102	6.2	8	28.6	22.5
IPE 200	200	100	5.6	8.5	28.5	22.4
W12x65	308	305	9.9	15.4	123	97
HEA 320	310	300	9	15.5	124.4	97.6
W16x45	410	179	8.8	14.3	85.2	66.9
IPE 400	400	180	8.6	13.5	84.5	66.3

Table 4.2: IPE beams with parallel flange according to Euronorm 19-57 (23)

Designation	Dimensions					Area	Weight	Dimensions for detailing					Surface	
	h mm	b mm	t_w mm	t_f mm	r mm	A mm ²	G kg/m	h_i mm	d mm	Ø	Pmin mm	Pmax mm	A _L m ² /m	A _G m ² /t
IPE 80	80	46	3.8	5.2	5.0	764	6.0	69.6	59.6	-	-	-	0.328	54.64
IPE 100	100	55	4.1	5.7	7.0	1030	8.1	88.6	74.6	-	-	-	0.400	49.33
IPE 120	120	64	4.4	6.3	7.0	1320	10.4	107.4	93.4	-	-	-	0.475	45.82
IPE 140	140	73	4.7	6.9	7.0	1640	12.9	126.2	112.2	-	-	-	0.551	42.70
IPE 160	160	82	5.0	7.4	9.0	2010	15.8	145.2	127.2	-	-	-	0.623	39.47
IPE 180	180	91	5.3	8.0	9.0	2390	18.8	164.0	146.0	M10	48	48	0.698	37.13
IPE 200	200	100	5.6	8.5	12.0	2850	22.4	183.0	159.0	M10	54	58	0.768	34.36
IPE 220	220	110	5.9	9.2	12.0	3340	26.2	201.6	177.6	M12	60	62	0.848	32.36
IPE 240	240	120	6.2	9.8	15.0	3910	30.7	220.4	190.4	M12	66	68	0.922	30.02
IPE 270	270	135	6.6	10.2	15.0	4590	36.1	249.6	219.6	M16	72	72	1.041	28.86
IPE 300	300	150	7.1	10.7	15.0	5380	42.2	278.6	248.6	M16	72	86	1.160	27.46
IPE 330	330	160	7.5	11.5	18.0	6260	49.1	307.0	271.0	M16	78	96	1.254	25.52
IPE 360	360	170	8.0	12.7	18.0	7270	57.1	334.6	298.6	M22	88	88	1.353	23.70
IPE 400	400	180	8.6	13.5	21.0	8450	66.3	373.0	331.0	M22	96	98	1.467	22.12
IPE 450	450	190	9.4	14.6	21.0	9880	77.6	420.8	378.8	M24	100	102	1.605	20.69
IPE 500	500	200	10.2	16.0	21.0	11600	90.7	468.0	426.0	M24	102	112	1.744	19.23
IPE 550	550	210	11.1	17.2	24.0	13400	106.0	515.6	467.6	M24	110	122	1.877	17.78
IPE 600	600	220	12.0	19.0	24.0	15600	122.0	562.0	514.0	M27	116	118	2.015	16.45
***	***	***	***	***	***	***	***	***	***	***	***	***	***	***

Table 4.3: Wide Flange Beams according to ASTM A6 / A6M – 17

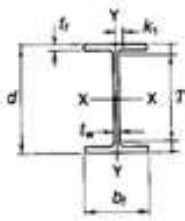

W Shapes Dimensions

Shapes	Area A	Depth d		Web		Flange				Distance		
				Thickness t _w		Width b _f		Thickness t _f		k _f	T	Work- able Gage
				in.		in.		in.		in.	in.	in.
W 33 x 118	34.7	32.9	32%	0.550	9/16	11.5	11 1/2	0.740	3/4	1 1/8	29 5/8	5 1/2
x 130	38.3	33.1	33 1/8	0.580	9/16	11.5	11 1/2	0.855	7/8	1 1/8	↓	↓
x 141	41.6	33.3	33 1/4	0.605	5/8	11.5	11 1/2	0.960	15/16	1 1/8	↓	↓
x 152	44.8	33.5	33 1/2	0.635	5/8	11.6	11 5/8	1.06	1 1/16	1 1/8	↓	↓
x 169	49.5	33.8	33%	0.670	1 1/16	11.5	11 1/2	1.22	1 1/4	1 3/8	↓	↓
W 33 x 201	59.2	33.7	33%	0.715	1 1/16	15.7	15 3/4	1.15	1 1/8	1 3/8	29 5/8	5 1/2
x 221	65.2	33.9	33%	0.775	3/4	15.8	15 3/4	1.28	1 1/4	1 3/8	↓	↓
x 241	71.0	34.2	34%	0.830	13/16	15.9	15 7/8	1.40	1 3/8	1 1/4	↓	↓
x 263	77.5	34.5	34 1/2	0.870	7/8	15.8	15 3/4	1.57	1 9/16	1 1/4	↓	↓
x 291	85.7	34.8	34%	0.960	15/16	15.9	15 7/8	1.73	1 3/4	1 5/8	↓	↓
x 318	93.6	35.2	35 1/8	1.04	1 1/16	16.0	16	1.89	1 7/8	1 5/8	↓	↓
x 354	104.0	35.6	35 1/2	1.16	1 3/16	16.1	16 1/8	2.09	2 1/16	1 3/8	↓	↓
x 387	114.0	36.0	36	1.26	1 1/4	16.2	16 1/4	2.28	2 1/4	1 7/8	↓	↓

4.9 Bracing

The bearing structures of industrial buildings form a load-bearing frame designed to perceive and transmit existing loads to a base of the building. Bearing skeleton, as a rule, accept on the frame scheme formed by vertical bearing elements on which the frame bolts rest. Frames can have either rigid or articulation of elements. In one-story industrial buildings, as usual, a structural scheme is used with the articulation of the crossbar of a frame with a column and rigid sealing of the columns in foundations, for example a two-hinged scheme. Other schemes can also be used (three-hinged, hinge less).

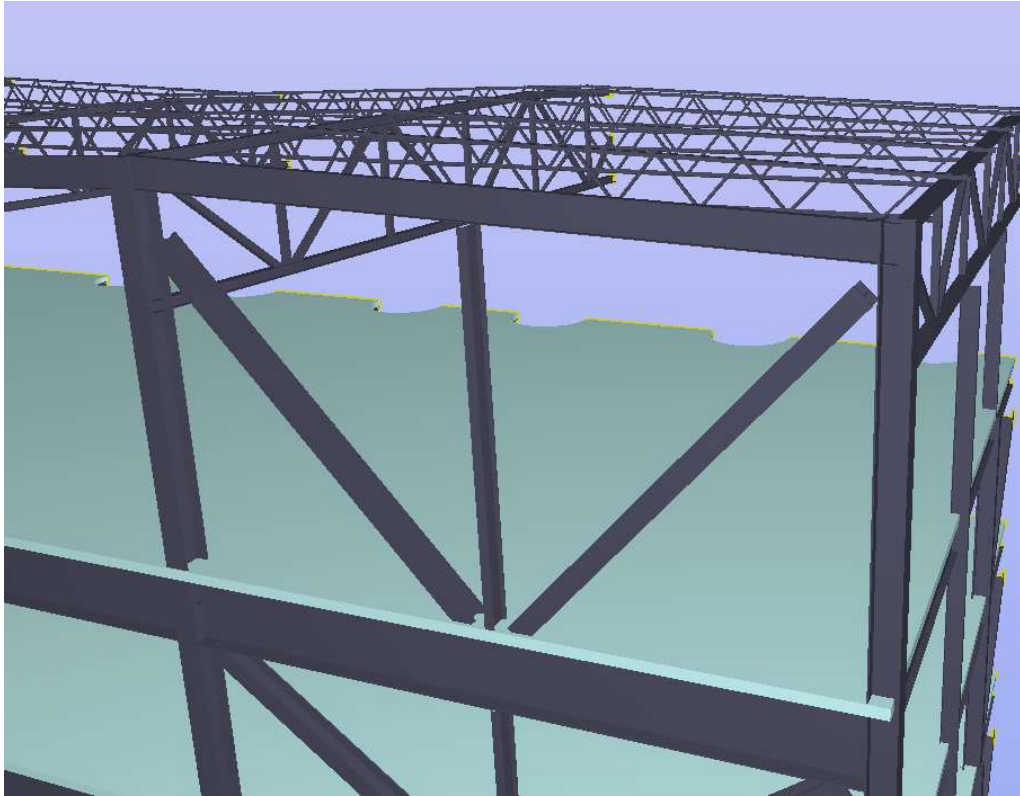

Figure 4.13. Cross bracing

The spatial rigidity of the building in the longitudinal direction is provided by the foundation beams, as well as by the discs of the covering and overlapping and by the ties.

Vertical bracing located along the line of the building columns creates stiffness and geometric invariability of the frame columns in the longitudinal direction (Figure 4.13). They are arranged for each temperature block. A temperature block is a section along the length of the building between the temperature seams or between the temperature seam and the nearest outer wall of the building.

In the buildings of low height (at a column height of up to 7 ... 8 m), connections between the columns cannot be arranged. In buildings of higher altitude, cross or portal connections are envisaged. Cross connections are applied at a step of 6 m, gantry (Figure 4.14) - at 12 m; they are made from rolling corners and connected to columns by welding the headscarf with cross pieces.

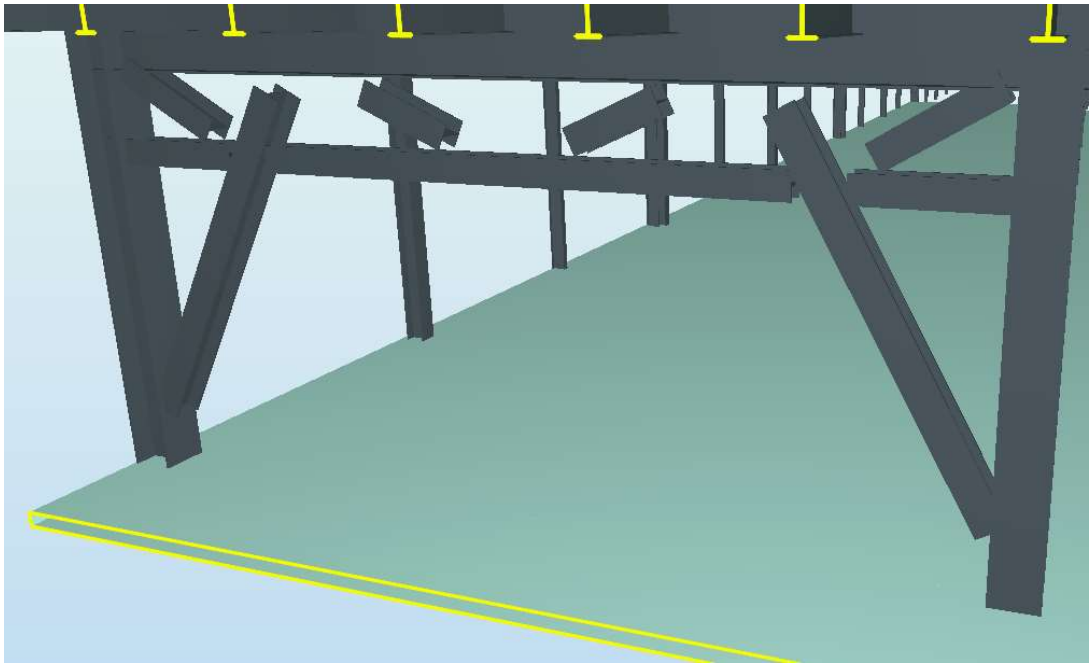

Figure 4.14. Portal bracing

Figure 4.15 shows the bracing arrangement in the building with steel primary floor beams spanning 40 ft., and figure 4.16 shows the bracing arrangement. The primary beams support secondary steel beams which support the concrete floor slabs. The beams and concrete slab act in composite action and the concrete slab also acts as a diaphragm providing stability to the interior bays by transferring lateral loads to the exterior braced frames. The roof composition consisting of membrane and insulation is carried by steel roof deck supported by secondary beams. The secondary beams are supported by steel trusses spanning 80 ft. The top chord of the roof trusses are inclined providing slopes of 1:30 to the roof for drainage.

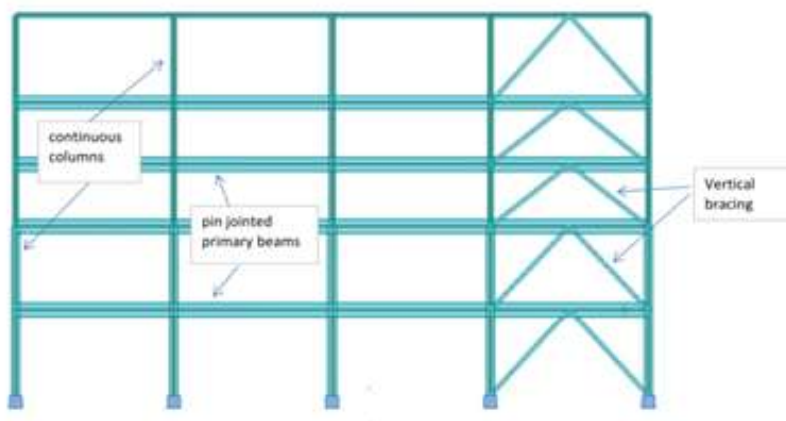

Figure 4.15. Bracing arrangement 1

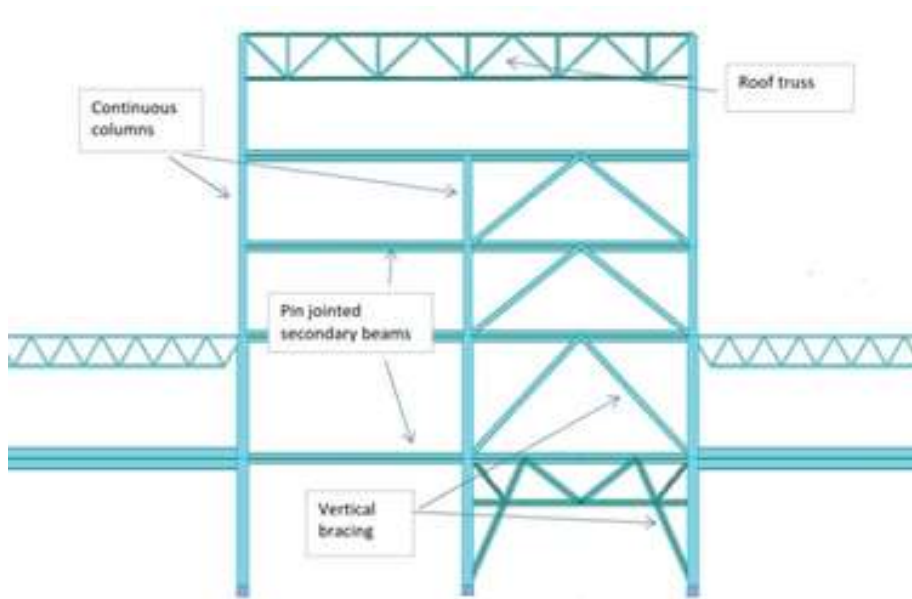

Figure 4.16. Bracing arrangement 2

4.10 Trusses

Steel pitched truss are outlined with parallel belts, polygonal and triangular. Steel farms are used for almost any spans. Certain lattice systems are used in trusses of different shapes. The choice of the type of grating depends on the scheme of application of loads, outline of belts and design requirements. To reduce the complexity of manufacturing, a farm shall be as simple as possible and with a minimum number of elements (Figure 4.17 and 4.18).

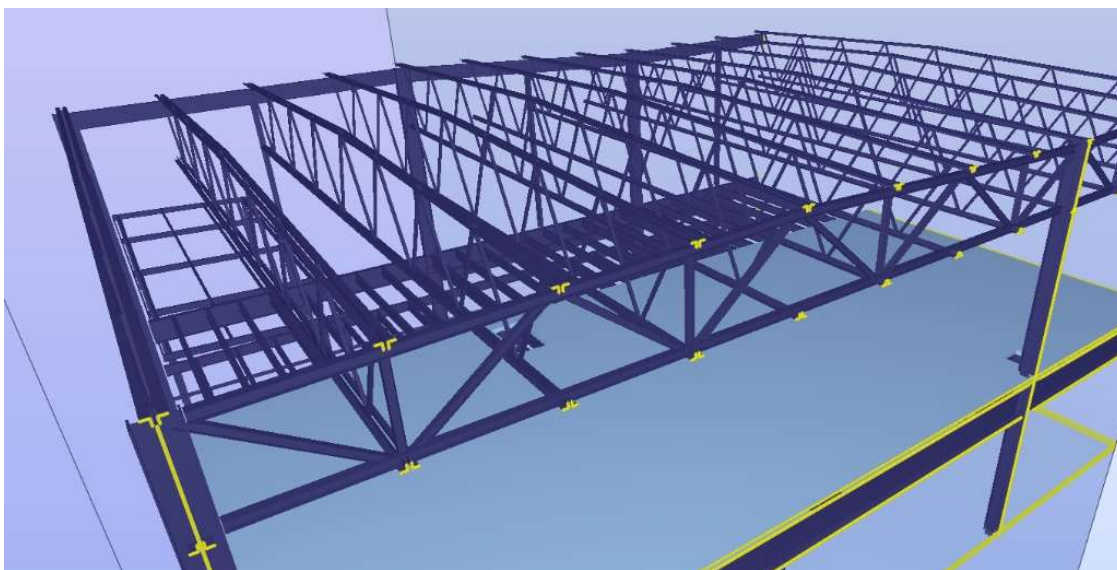

Figure 4.17. Pitched truss 1

Uniform trusses (with parallel upper and lower chords) are designed from L-shaped sections with normal or reduced truss height. Constructions of normal height trusses are intended for heated industrial buildings with coated reinforced concrete slabs or from steel profiled decking laid on purlins. Trusses with reduced height are used only for coverings from profiled flooring.

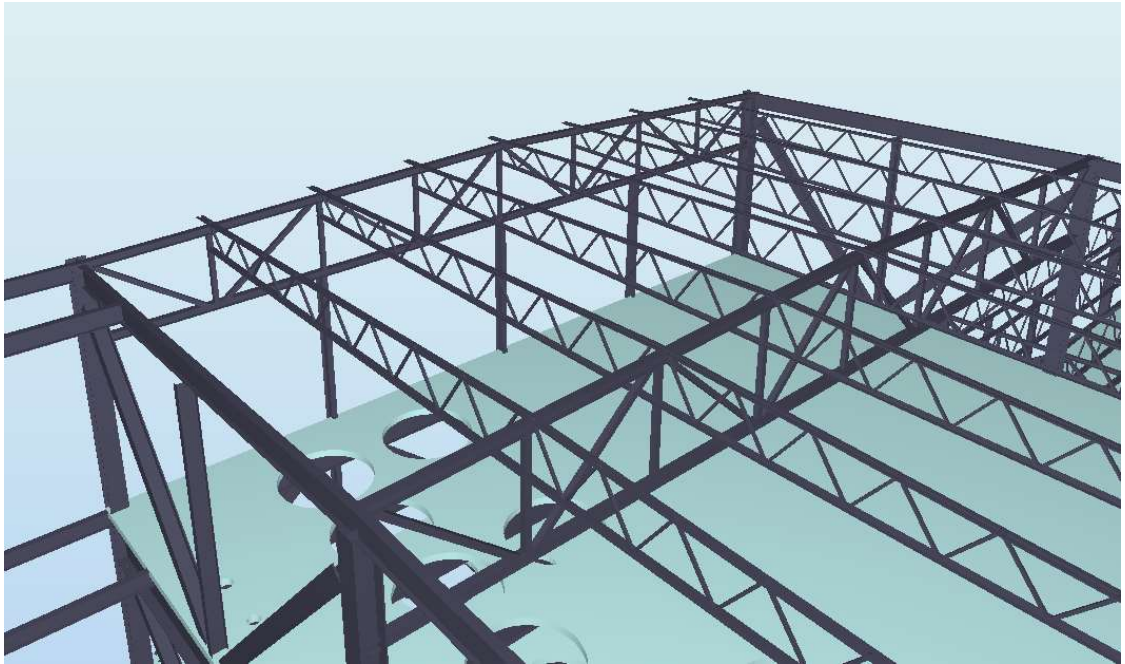

Figure 4.18. Pitched truss 2

4.11 Corrosion protection

Corrosion protection of structures shall be considered to intervene in this process in order to prevent the reaction, or to greatly reduce the rate of corrosion. Cost effective corrosion protection of structural steelwork shall present little difficulty for common applications and environments if the factors that affect durability are recognized from the outset.

The purpose of this guide is to explain, in terms of concepts, the basic requirements for protecting structural steel with paint and metallic coatings, the systems commonly used, and their significance in relation to the protective properties required (Figure 4.19).

In external or wet environments, design can have an important bearing on the corrosion of steel structures. In dry heated interiors, no special precautions are

necessary. The prevention of corrosion shall, therefore, be taken into account during the design stage of a project.

The standard corrosion protection system can be broadly classified into two categories:

- Paint Coating system
- Metal Coating system

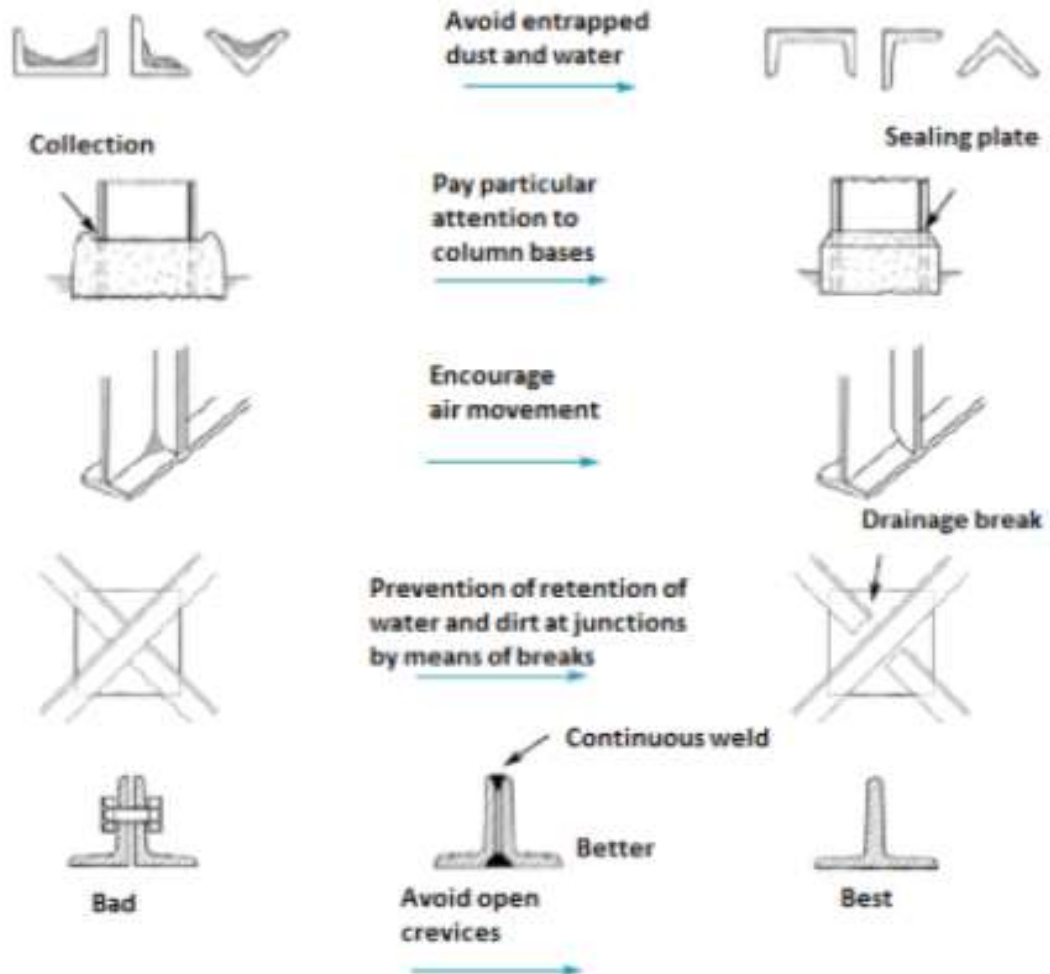

Figure 4.19 Detailing to minimize corrosion (37).

5 LOADS

5.1 Classification of loads

Loads on buildings and structures in accordance with the requirements of US building codes are conventionally divided into vertical and horizontal (or side) loads (Table 5.1.).

Table 5.1: Building Loads Categorized by Orientation

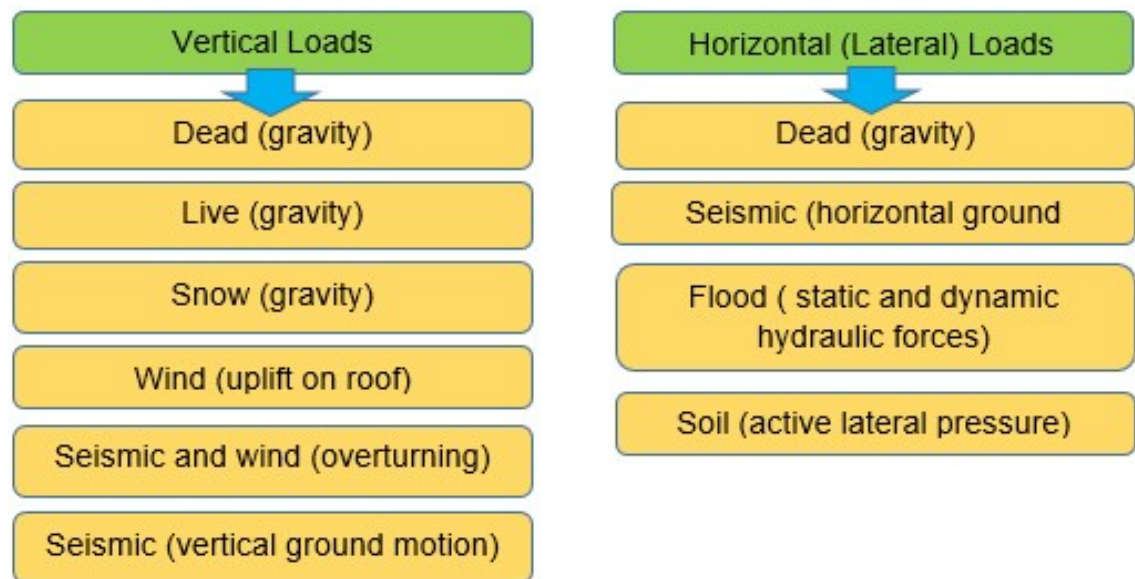

Loads are defined in the US based on the concept of a period of recurrence. This concept characterizes the time during which a certain load value is expected to be reached or once exceeded. At the same time, they are considered as annual extremes (the greatest loads, possible once in any year), and the maximum values of loads for the entire lifetime of the structure.

Historically, safety factors according to the allowable stress method corresponded to loads with a repeat period of 50 years. With the development of the limit state method, repeatability periods for some loads have been corrected. The methods for determining the loads depend on their type, as well as on the sufficiency and reliability of the initial data for estimating the loads. For example, wind loads are determined based on probabilistic analysis of wind speeds measured at weather stations. For wind speeds, as a rule, the absence of the required volumes of long-term measurements is typical.

Snow loads are based on the data of the snow depth at ground level, and they shall be led to the roof level using transition coefficients derived from the results of experimental studies. Seismic loads are defined taking into account historical information on various models, directly or indirectly confirming the consequences of past earthquakes. Estimation of seismic hazard is inherent significant uncertainties. This is especially true for areas with historically low seismicity, but with great potential for serious seismic events.

Temporary loads from people and equipment installed are modeled based on data of loading conditions, taking into account-simplified hypotheses.

There is no accidental load case which is specifically identified. There are many little nuances described in the code that engineers shall apply in order to avoid accidents (tolerances in construction & erecting, overloading of beams, material variations, etc.).

It is important to apply a notional load case which is equal to the vertical load times 0.005 and to apply it in horizontal direction. This takes into account stability of the structure (i.e. out of plane of columns, fabrication tolerances, etc.) For an accidental load, it is substantial what you are designing. For instance, a pipe rack shall withstand loads, which are not specified in the code, and there are great research papers already done on that subject. Moreover, when engineers use the LRFD method they “protect” a structure from structural failure by reducing the probability that such an error would occur.

In general, the loads are determined taking into account the accumulated data, drawing on the opinions of experts, which have been reflected in the construction norms and specifications.

5.2 The main provisions of the Allowable Stress Design

When designing by the method of permissible stresses, the resistance of the structure is compared with the loading effect, and the following relation must be observed:

$$\frac{R}{S.F.} \geq L \quad (1)$$

where R nominal resistance (or design stress), usually based on the fifth percentile strength property of interest (also known as the characteristic strength value), $S.F.$ - the safety factor ($R/S.F.$ is known as the allowable stress); L - the load effect caused by the nominal design load combination (in units of R)

Safety factors are always taken more than one. At the same time, the smallest safety factors are used when considering "noncritical" destruction, and the largest - in the design of critical structures, which are characterized by the greatest uncertainties (for example, links). In addition, increased safety factors are adopted when designing elements that are characterized by a sharp failure without the appearance of warning signs.

In connection with the variability of the properties of materials, the characteristic strength is determined in the United States by the results of statistical processing of material testing data. This processing and evaluation of the characteristic strength values are carried out in accordance with standard procedures (different for concrete, wood or steel). In most cases, the characteristic strength is taken with a 5% security, at which less strength values have less than 5% of samples.

An increase in the safety factor leads to an increase in the reliability of structures, and vice versa. Table 5.2. shows how the safety factors affect the level of reliability of the structure. As it can be seen, an increase in the safety factor has a disproportionate (nonlinear) effect on the reliability characteristic.

In general, safety factors by the method of permissible stresses in the US are assigned on the basis of the results of generalization of historical information and data of theoretical studies taking into account common sense. They can not be specially "tuned" to certain applications (for example, only for housing construction). In practice, various safety factors are used, which ensure different levels of structural reliability.

Table 5.2: Effect of Safety Factor on Level of Safety in ASD for a Typical Hurricane-Prone Wind Climate (21, p. 2-19)

A	B	C	D	E	F
ASD Safety Factor	Equivalent Wind Speed Factor (\sqrt{A})	Design Wind Speed (mph gust)	“Ultimate” Event Wind Speed B x C (mph, gust)	“Ultimate” Event Return Period (years)	Chance of Exceedance in a 50- Years Period
1,0	1,00	120	120	50	63,46%
2,0	1,41	120	170	671	7,18%
3,0	1,73	120	208	4,991	1,00%
4,0	2,00	120	240	27,318	0,18%

Note: The calculated wind speed is determined by multiplying the wind speed with a 50-year repeat period by an equivalent coefficient equal to the square root of the safety factor, due to the fact that the wind load is proportional to the square of the wind speed.

5.3 The main provisions of the Load Resistance Factor Design

When designing by the method of limiting states, the characteristics resistance with a sum of load effects:

$$\varphi R \geq \sum_i^N \gamma_i L_i \quad (2)$$

where φ is the resistance factor (phi); R - resistance (or voltage), usually 5% of the security (also known as the characteristic strength value); γ_i - overload factor for each i-th load in the considered combination of N loads; L_i is the stress created by each load in a nominal design load combination (in units of R).

The format of the method of limiting states is conservatively calibrated to the level of reliability achieved by the method of allowed voltages. In the USA, using the limit state method, the coefficients of two kinds are used, one of which relates to the loading effect, and the other to the resistance (or strength). It is be-

lieved that this is more correct from the point of view of providing reliability in relation to the method of allowable stresses.

The resistance coefficient φ is applied to the normative strength of the material. This coefficient is in the range 0.5 - 0.9 (with low values for the most variable strength characteristics or with the possibility of sudden failures without the appearance of warning signs). The coefficient of resistance also depends on the normative value of strength (the average value refers to it, or with 5% security, or the smallest of the test data set).

Overload factors γ_i are applied to each i -th load as part of a combination of N loads in order to account for the variability of the given load. They depend on the periods of repeatability of loads. In addition, in the USA, the overload factors take into account the nature of load distribution in combination (allow for the correlation between the probable values of loads in the case when one of the loads takes the maximum value). By the method of limiting states, the load factor for the maximum load in the combination of loads is in the range 1.0 - 1.6. For other loads in this combination, the coefficients are slightly less than 1. As a result, the level of reliability is determined by the resulting effect of the resistance and overload factors on the resistance and load side, respectively.

Figure 5.1 depicts the variable nature of building loads and resistance and the safety margin relative to design loads and nominal resistance.

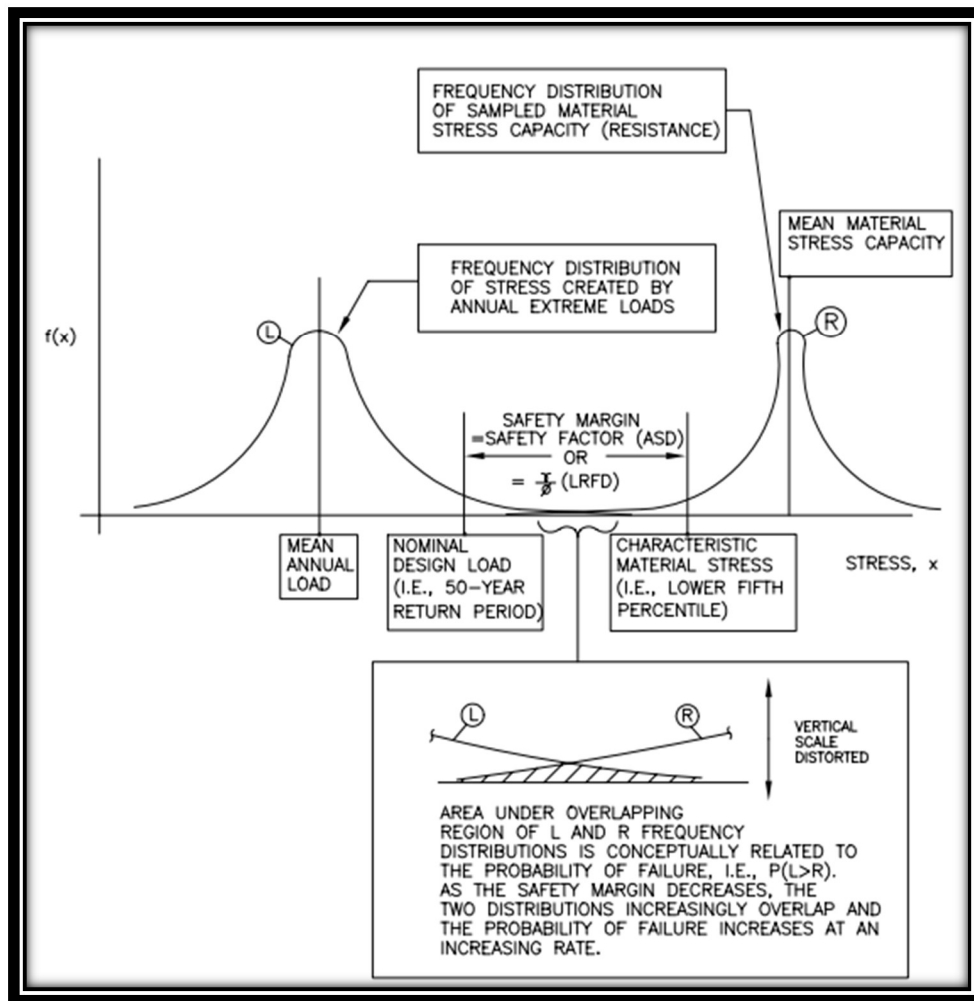

Figure 5.1. Basic Concept of Safety in LRFD and ASD Considering the Variability of Loads and Resistance (21, p. 2-21)

5.4 Loading combinations

Table 5.3 presents the load combinations according to the Load Resistance Factor Design and the Allowable Stress Design.

ASCE 7-05 provides load combination equations for both LRFD and ASD. The ones that you will use will depend on which of the two design philosophies that have been chosen for your project.

You will note that several of the load combination equations have multiple permutations due to use of "or" or "+" in the equations (both wind, W , and seismic, E , are considered to be + loads). This is true of both the LRFD and ASD combinations.

Table 5.3: LRFD and ASD load combinations, according to ASCE 7-10.

LRFD method:	ASD method:
1. $1.4D$	1. D
2. $1.2D + 1.6L + 0.5(L_r \text{ or } S \text{ or } R)$	2. $D + L$
3. $1.2D + 1.6(L_r \text{ or } S \text{ or } R) + (L \text{ or } 0.5W)$	3. $D + (L_r \text{ or } S \text{ or } R)$
4. $1.2D + 1.0W + L + 0.5(L_r \text{ or } S \text{ or } R)$	4. $D + 0.75L + 0.75(L_r \text{ or } S \text{ or } R)$
5. $1.2D + 1.0E + L + 0.2S$	5. $D + (0.6W \text{ or } 0.7E)$
6. $0.9D + 1.0W$	6a. $D + 0.75L + 0.75(0.6W) + 0.75(L_r \text{ or } S \text{ or } R)$
7. $0.9D + 1.0E$	6b. $D + 0.75L + 0.75(0.7E) + 0.75S$
	7. $0.6D + 0.7E$
	8. $0.6D + 0.6W$

where D is the dead load, E is the earthquake load, L is the live load, L_r is the roof live load, R is the rain load, S is the snow load and W is the wind load.

5.5 Load and Resistance Factor Design

If you chose to use LRFD for your design philosophy, then you are to make sure that your structure is capable of supporting the loads resulting from the seven ASCE 7-05 basic load combination equations.

LRFD applies load factors to service level loads so that they are safely comparable to member strengths (which are generally inelastic) while maintaining the actual (service) loads in the elastic region. Member strength (the maximum load that the member will support) is generally between 1.3 to 1.4 times the forces that will cause yielding in a member. These load factors are applied in the load combination equations and vary in magnitude according to the load type.

The magnitude of the LRFD load factors reflect the predictability of the loads. For example, the load factor for D is generally lower than the load factor for L in any given equation where there is equal probability of simultaneous occurrence of the full value of each load type. This is because dead loads are much more

predictable than live loads and, hence, do not require as great of a factor of safety.

Example:

Analysis of a structure shows that a particular member supports 5 kips dead load and 6 kips live load. Using LRFD LC-2, the combined design load equals 1.2 times the dead load plus 1.6 times the live load, or 15.6 kips. The factor for dead load (1.2) is lower than the factor for live load (1.6) because dead load is more predictable than live load. The load factors are all greater than 1.0 since we want to compare the result to the ultimate strength of the member instead of the yielding strength of the member yet we do not want yielding to occur. The ultimate strength is generally about 1.3-1.4 times the yield strength of the member.

5.6 Allowable Strength Design

For ASD there are eight basic load combination equations. You will notice that the large load factors found in the LRFD load combinations are absent from the ASD version of the ASCE 7-05 load combination equations. In addition, the predictability of the loads is not considered. For example, both D and L have the same load factor in equations where they are both likely to occur at full value simultaneously. The probability associated with accurate load determination is not considered at all in the ASD method. Hence, the major difference between LRFD and ASD.

Example:

Analysis of a structure shows that a particular member supports 5 kips dead load and 6 kips live load. Using ASD LC-2, the combined design load equals the dead load plus the live load, or 11.0 kips. The factor for dead load (1.0) is the same as the factor for live load (1.0), hence not accounting for the fact that the dead load is more predictable than the live load. The result of the load combination equation is then generally compared against the yielding strength of the member to ensure elastic behavior.

6 REQUIREMENTS FOR STRUCTURAL ELEMENTS

6.1 Deflections and displacements

Limiting values for allowed deflections in serviceability limit state:

- Platform beams, total load $f \leq L/300$
- Secondary platform beams, total load $f \leq L/240$
- Roof beams, total load $f \leq L/240$
- Roof purlins, total load $f \leq L/200$
- Gratings $f \leq L/200$
- Wall purlin, wind load $f \leq L/150$
- Beams supporting main equipment
 - Total load $f \leq L/400$
 - Live load $f \leq L/600$
- Deflection of steel frame, wind load $f \leq H/400$
- Deflection of the columns between bracing levels $f \leq H/400$

6.2 Structural design loads

6.2.1 General

It should be noted that absolute reliability for any structure is almost unattainable. Any theory or calculation technique used to assess reliability is relative. The results of their application should be interpreted taking into account the inherent uncertainty. The characteristics of reliability should take into account historical experience. It is important to understand the place of risk associated with design failures, with respect to other risks, as well as assess the economic consequences of structural damage. Economic considerations become more important over time, and they are necessarily taken into account when adjusting building norms.

Constructive reliability is a multifaceted characteristic, reflecting a number of objective and subjective project aspects, and among them:

- strength characteristics (taking into account the properties of materials and their variability in space and time);
- the magnitude of the loads (taking into account statistical representations and the uncertainty of these representations);
- various uncertainties associated with the competence of designers and the accuracy of calculation methods, as well as with construction technologies, the durability of structures.

The following initial data are used in the design:

- characteristic strength of materials (for example, metal, wood, concrete, etc.);
- rated loads and their combinations;
- an acceptable level of reliability (or margin of safety).

Various probabilistic concepts are widely used in designing. The involvement of these concepts is especially necessary for understanding the meaning of the safety factor considered in the design by the allowable stress method

Load Combinations – per 2012 IBC Section 1605, and ASCE 7-10 Chapter 2

Occupancy Group - International Building Code 2012 (IBC 2012) Chapter 3

Live loads

Table 6.1 shows some values of the action variables (L.L.), defined for different building types. You can see the difference in the coefficients. In some cases, the observed differences reached 60% of the increase in the intensity of the live load.

Table 6.1: Comparison of variable action intensities in different studied codes

Use	Code	Corridors (kN/m ²)	Balconies (kN/m ²)	Stairs (kN/m ²)	Floors (kN/m ²)
Residential	ACI 318-14	4.80	4.80	4.80	1.90
	ASCE 7-10	4.79	2.88	4.79	1.92
	EC2	2.00	4.00	3.00	2.00
Offices	ACI 318-14	4.80	4.80	4.80	2.40
	ASCE 7-10	3.83	3.60	4.79	2.40
	EC2	3.00	3.00	3.00	3.00
Shops	ACI 318-14	6.00	-	4.80	6.00
	ASCE 7-10	6.00	-	4.79	6.00

Live loads

Each floor will be designed to support the live loads listed below in addition to the equipment loads, piping loads, and electrical loads supported by the floor.

- Elevated Floors
- Heavy maintenance areas
- Light maintenance areas (including walkways)
- Control Room
- Electrical Rooms
- Slabs on Grade
- Areas accessible by forklifts front axle load
- Corridors, stairs
- Equipment platforms
- structural members
- grating w/ limited access
- Roof loads
- Minimum Live Load (Snow)
- Wind load

Use and Occupancy Classification (Live loads):

1. Assembly: Groups A-1, A-2, A-3, A-4 and A-5
2. Business: Group B
3. Educational: Group E
4. Factory and Industrial: Groups F-1 and F-2
5. High Hazard: Groups H-1, H-2, H-3, H-4 and H-5
6. Institutional: Groups I-1, I-2, I-3 and I-4
7. Mercantile: Group M
8. Residential: Groups R-1, R-2, R-3 and R-4
9. Storage: Groups S-1 and S-2
10. Utility and Miscellaneous: Group U

ASCE 7-10

6.2.2 Dead load

Dead loads on the platforms, as listed below (including secondary beams)

- Platform generally
- Platform on hauling areas
- Roof
- Walls

Table 6.2: Risk Category of Buildings and Other Structures for Flood, Wind, Snow, Earthquake, and Ice Loads (ASCE 7-10, Table 1.5-1)

Risk Category of Buildings and Other Structures for Flood, Wind, Snow, Earthquake, and Ice Loads	
Use or Occupancy of Buildings and Structures	Risk Category
Buildings and other structures that represent low risk to human life in the event of failure.	I
All buildings and other structures except those listed in Risk Categories I, III, and IV.	II
Buildings and other structures, the failure of which could pose a substantial risk to human life. Buildings and other structures, not included in Risk Category IV, with potential to cause a substantial economic impact and/or mass disruption of day-to-day civilian life in the event of failure. Buildings and other structures not included in Risk Category IV (including, but not limited to, facilities that manufacture, process, handle, store, use, or dispose of such substances as hazardous fuels, hazardous chemicals, hazardous waste, or explosives) containing toxic or explosive substances where the quantity of the material exceeds a threshold quantity established by the authority having jurisdiction and is sufficient to pose a threat to the public if released.	III
Buildings and other structures designated as essential facilities. Buildings and other structures, the failure of which could pose a substantial hazard to the community. Buildings and other structures (including, but not limited to, facilities that manufacture, process, handle, store, use, or dispose of such substances as hazardous fuels, hazardous chemicals, or hazardous waste) containing sufficient quantities of highly toxic substances where the quantity of the material exceeds a threshold quantity established by the authority having jurisdiction and is sufficient to pose a threat to the public if released. Buildings and other structures required to maintain the functionality of other Risk Category IV structures.	IV

6.2.3 Wind load

Wind loads will be calculated in accordance with Section 1609.1.1 of IBC 2012, which refers to ASCE 7-10. IBC 2012 1609.6 Alternative all-heights method may be utilized for wind load determination, if conditions of that section are met, as an alternative to ASCE 7- 10 Chapters 27 & 30.

Ultimate Wind Speed

Nominal Wind Speed

Exposure Categories can have a significant effect on the design wind pressures for fenestration products such as vehicular access doors. For such doors, the design wind pressure values can vary by 30% or more, resulting in doors with a great difference in materials needed. This article will overview some easy-to-recognize conditions that would help distinguish between Exposure B and Exposure C, two common alternatives to choose from at a building site.

What are Exposures B and C?

It is important to know how ASCE 7, Minimum Design Loads for Buildings and Other Structures, describes each category. ASCE 7 is the standard by which wind pressures are determined, and is referenced in model codes adopted as base codes by every U.S. state.

Exposure Categories are based on "surface roughness", defined as follows for buildings less than 30 feet high.

Exposure B: Urban and suburban areas, wooded areas, or other terrain with numerous closely spaced obstructions having the size of single-family dwellings or larger, prevailing for a distance greater than 1,500 feet in any direction from the installation.

Exposure C: Open terrain with scattered obstructions having heights generally less than 30 feet. (Commonly associated with flat open country and grasslands).

A Word about Exposure D

Exposure D involves a structure a close distance (typically within 600 feet) from an "open waterway" one mile or more across. This category is readily distin-

guishable, where the locally enforced code very likely has considered this in their requirements.

Figures 6.1 and 6.2 present examples of Wind Exposure Categories:



Figure 6.1. Exposure B Example (Source: ASCE 7-10)



Figure 6.2. Exposure C Example (Source: ASCE 7-10)

Importance Factor is determined from Design Loads for Buildings and Other Structures (ASCE 7) based on the Occupancy Category. It is utilized in calculat-

ing flood, wind, snow, seismic and ice design loads. They are shown in Table 6.3. The Importance Factor is a multiplier that increases or decreases the base design loads. Typically, the base design loads are outlined by the code as a 2% annual probability of exceedance (2% in 50 years for seismic loads). Therefore, an elevated Importance Factor creates proportionally higher design loads (i.e., a wind Importance Factor of 1.15 is a 15% increase in design wind loads).

Table 6.3: Importance Factor (ASCE 7-10,Table 1.5-2)

Occupancy Category	Importance Factors		
	Wind, I_w	Snow, I_s	Earthquake, I_E
I	0.87	0.80	1.00
II	1.00	1.00	1.00
III	1.15	1.10	1.25
IV	1.15	1.20	1.50

Directionality Factor:

The directionality factor (K_d) (Table 6.3) used in the ASCE 7 wind load provisions for components and cladding is a load reduction factor intended to take into account the less than 100% probability that the design event wind direction aligns with the worst case. Directionality Factor K_d has been calibrated with combinations of loadsuiling aerodynamics.

Table 6.3: Wind Directionality Factor, K_d (ASCE 7-10, Table 6-4)

Structural Type	Directionality factor K_d
Buildings	
Main Wind Force Resisting System	0.85
Components and Cladding	0.85
Ached Roofs	0.85
Chimneys, Tanks, and Similar Structures	
Square	0.90
Hexagonal	0.95
Round	0.95
Solid Freestanding Walls and Solid Freestanding and Attached Signs	0.85
Open Signs and Lattice Framework	0.85
Trussed Towers	
Triangular, square, rectangular	0.85
All other cross sections	0.95

Topographic Factor

The wind speed-up effect shall be included in the calculation of design wind loads by using the factor K_{zt}:

$$K_{zt} = (1 + K_1K_2K_3)^2$$

where K₁, K₂, and K₃ are given in Figure 6.3.

Wind speed-up effects at isolated hills, ridges, and escarpments constituting abrupt changes in the general topography, located in any exposure category, shall be included in the determination of the wind loads when buildings and other site conditions and locations of structures meet all of the following conditions.

The hill, ridge, or escarpment is isolated and unobstructed upwind by other similar topographic features of comparable height for 100 times the height of the topographic feature (100H) or 2 mi (3.22 km), whichever is less. This distance shall be measured horizontally from the point at which the height H of the hill, ridge, or escarpment is determined.

The hill, ridge, or escarpment protrudes above the height of upwind terrain features within a 2-mi (3.22-km) radius in any quadrant by a factor of two or more.

The structure is located as shown in Figure 6.3 in the upper one-half of a hill or ridge or near the crest of an escarpment.

$$H/L_h \geq 0.2$$

H is greater than or equal to 15 ft (4.5 m) for Exposure C and D and 60 ft (18 m) for Exposure B. An example of the Topographic Multipliers for Exposure C shown in table 6.4.

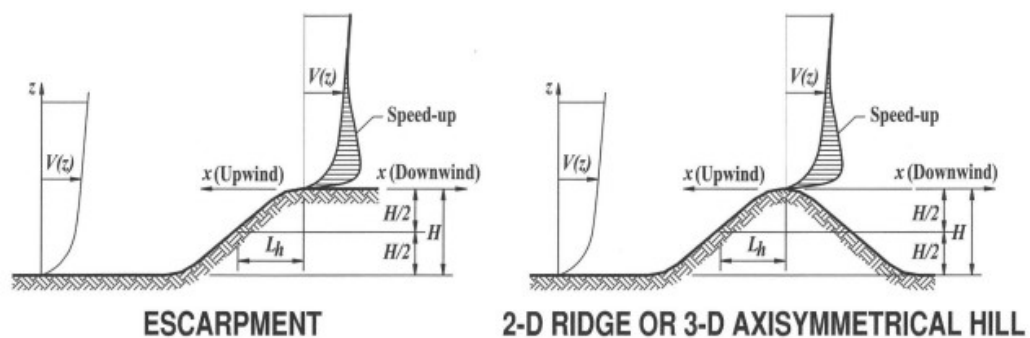

Figure 6.3. Topographic Factor, K_{zt} (ASCE 7-10)

Table 6.4: Topographic Multipliers for Exposure C (ASCE 7-10, Table 26.8-1)

Topographic Multipliers for Exposure C										
H/L_h	K_1 Multiplier			x/L_h	K_2 Multiplier		z/L_h	K_3 Multiplier		
	2-D Ridge	2-D Escarp	3-D Axisym Hill		2-D Escarp	All Other Cases		2-D Ridge	2-D Escarp	3-D Axisym Hill
0.20	0.29	0.17	0.21	0.00	1.00	1.00	0.00	1.00	1.00	1.00
0.25	0.36	0.21	0.26	0.50	0.88	0.67	0.10	0.74	0.78	0.67
0.30	0.43	0.26	0.32	1.00	0.75	0.33	0.20	0.55	0.61	0.45
0.35	0.51	0.30	0.37	1.50	0.63	0.00	0.30	0.41	0.47	0.30
0.40	0.58	0.34	0.42	2.00	0.50	0.00	0.40	0.30	0.37	0.20
0.45	0.65	0.38	0.47	2.50	0.38	0.00	0.50	0.22	0.29	0.14
0.50	0.72	0.43	0.53	3.00	0.25	0.00	0.60	0.17	0.22	0.09
				3.50	0.13	0.00	0.70	0.12	0.17	0.06
				4.00	0.00	0.00	0.80	0.09	0.14	0.04
							0.90	0.07	0.11	0.03
							1.00	0.05	0.08	0.02
							1.50	0.01	0.02	0.00
							2.00	0.00	0.00	0.00

The gust-effect factor for a rigid building or other structure is permitted to be taken as 0.85.

6.2.4. Snow load

The design snow load for roofs will be calculated considering the shape of the roof, drift effects and sliding effects in accordance with Section 1608 of IBC. The ground snow load is according to ASCE 7-10, Figure 6.4.

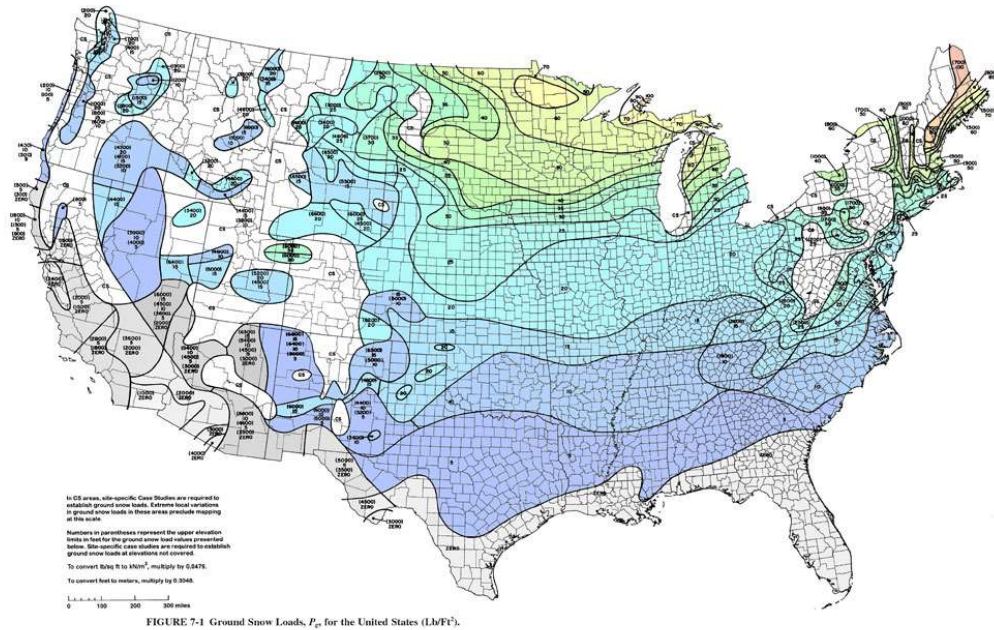

Figure 6.4 Ground Snow Loads, P_g , for the United States (Lb/Ft²) (ASCE 7-10)
 Importance Factor for Snow Ice, and Earthquake Loads

The values of the importance factors shall be determined from Table 6.5 based on the Risk Category from Table 6.1.

Table 6.5: Importance Factors by Risk Category of Buildings and Other Structures for Snow, Ice, and Earthquake Loads (ASCE 7-10, Table 1.5-2)

Risk Category from	Snow Importance Factor, I_s	Ice Importance Factor-Thickness, I_i	Ice Importance Factor-Wind, I_w	Seismic Importance Factor, I_e
I	0.80	0.80	1.00	1.00
II	1.00	1.00	1.00	1.00
III	1.10	1.25	1.00	1.25
IV	1.20	1.25	1.00	1.50

Figures 6.5, 6.6 and 6.7 show the coefficients of snow loads, depending on the shape of the roof. It can be concluded that in both cases there is dependency of

snow factors from the shape of the roof. For inclined roofs in accordance with ASCE 7-10, there are two ways of loading, and in EC3 with this type of roof, it is necessary to consider 3 loading cases.

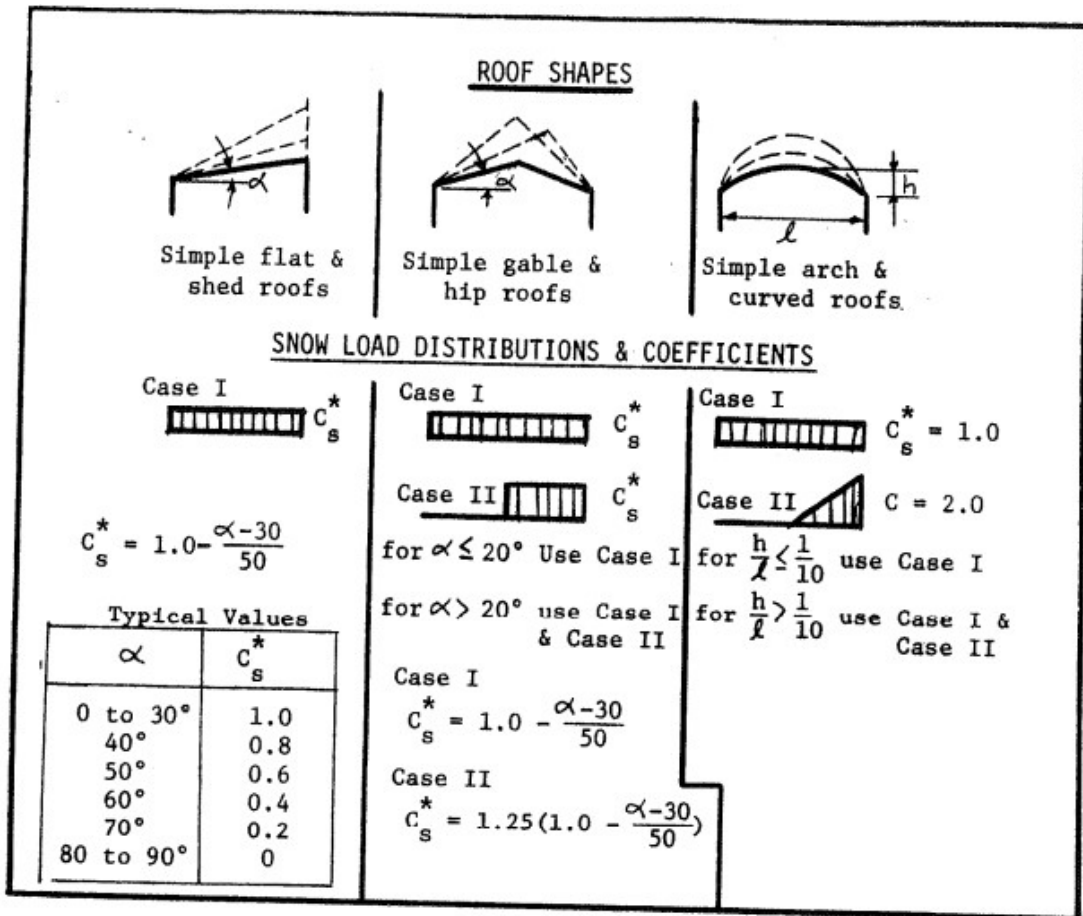

Fig C2-1
Flat & Shed Roofs

Fig C2-2
Gable or Hip Roofs

Fig C2-3
Arch Roofs

Notes:

1. In Figs C2-1 & C2-2 the term $\frac{\alpha - 30}{50}$ is only valid for slopes greater than 30°.
2. C_s^* = coefficient to be applied to Basic Roof Snow Load.
3. C = coefficient to be applied to Basic Ground Snow Load.

Figure 6.5 Roof shapes and snow load coefficients for flat, shed, gable, hip, arch roofs (33, p.105)

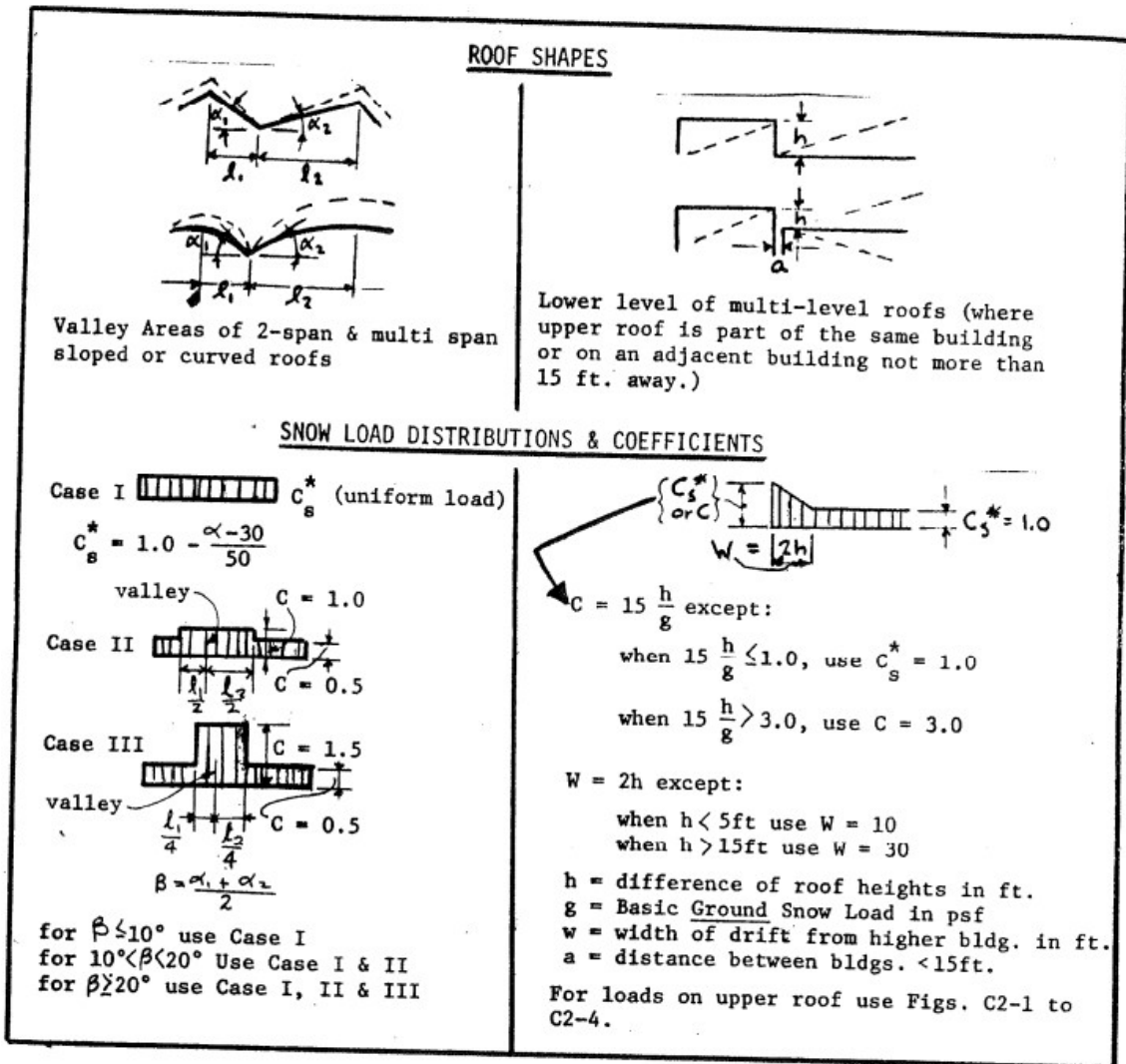

Fig. C2-4
Valley Areas of 2-span & Multi Span Sloped or Curved Roofs.

Fig. C2-5
Lower Roof of Multi-Level Roofs.

Notes:

1. In Fig C2-4 the term $\frac{\alpha - 30}{50}$ is only valid for slopes greater than 30° .
2. C_s^* = coefficient to be applied to Basic Roof Snow Load.
3. C = coefficient to be applied to Basic Ground Snow Load.

Figure 6.6 Roof shapes and snow load coefficients for valley areas of 2-span, multi span slope, curved, lower and multi-level roofs (33, p.106)

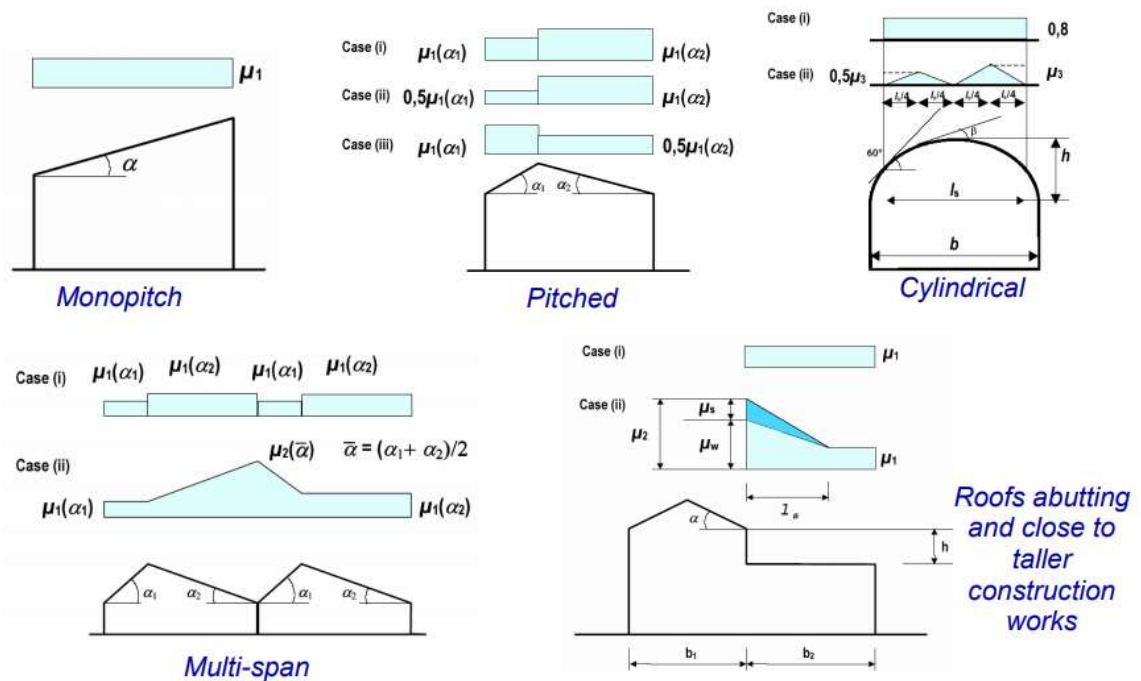

Figure 6.7. Shape coefficients for the following types of roofs according to EN 1991-1-3.

6.2.5. Seismic load

Seismic loads shall be calculated in accordance with Section 1615 of IBC.

A Seismic Design Category is a classification according to the table 6.6 assigned to a structure based on its occupancy or use (Occupancy Category) and a level of expected soil modified seismic ground motion.

Table 6.6: Meaning of Seismic Design Category

Seismic Design Category	What does it mean?
A	Very small seismic vulnerability
B	Low to moderate seismic vulnerability
C	Moderate seismic vulnerability
D	High seismic vulnerability
E and F	Very high seismic vulnerability and near a major fault

All other structures shall be assigned to a seismic design category based on their risk category and the design spectral response acceleration parameters, S_{DS} and S_{D1} .

Each building and structure shall be assigned to the more severe seismic design category in accordance with Table 6.7, irrespective of the fundamental period of vibration of the structure, T .

Determine the 5% damped design spectral response accelerations S_{DS} at short period and S_{D1} at long period in accordance with IBC 1613.3.4.

$$S_{DS} = (2 / 3) S_{MS}$$

$$S_{D1} = (2 / 3) S_{M1}$$

where:

S_{MS} = the maximum considered earthquake spectral response accelerations for short period as determined

S_{M1} = the maximum considered earthquake spectral response accelerations for long period as determined

Table 6.7: Seismic Design Category Based on Short Period Response Acceleration Parameter (ASCE 7-10, Table 11.6-1)

Value of S_{DS}	Risk Category	
	I or II or III	IV
$S_{DS} < 0.167$	A	A
$0.167 \leq S_{DS} < 0.33$	B	C
$0.33 \leq S_{DS} < 0.50$	C	D
$0.50 \leq S_{DS}$	D	D

6.2.6. Site Soil Classification (for the calculation of foundations)

The site soil shall be classified in accordance with Table 6.8 based on the upper 100 ft (30 m) of the site profile. Where site-specific data are not available to a depth of 100 ft (30 m), appropriate soil properties are permitted to be estimated by the registered design professional preparing the soil investigation report based on known geologic conditions. Where the soil properties are not known in sufficient detail to determine the site class, Site Class D shall be used unless the authority having jurisdiction or geotechnical data determine Site Class E or F soils are present at the site. Site Classes A and B shall not be assigned to a site if there is more than 10 ft (10.1 m) of soil between the rock surface and the bottom of the spread footing or mat foundation.

Table 6.8: Site Classification (ASCE 7-10, Table 20.3-1)

Site Classification			
Site Class	\bar{v}_s	\bar{N} or \bar{N}_{ch}	\bar{s}_u
A. Hard rock	>5,000 ft/s	NA	NA
B. Rock	2,500 to 5,000 ft/s	NA	NA
C. Very dense soil and soft rock	1,200 to 2,500 ft/s	>50	>2,000 psf
D. Stiff soil	600 to 1,200 ft/s	15 to 50	1,000 to 2,000 psf
E. Soft clay soil	<600 ft/s	<15	<1,000 psf
Any profile with more than 10 ft. of soil having the following characteristics: —Plasticity index $PI > 20$, —Moisture content $w \geq 40\%$, —Undrained shear strength $s_u < 500$ psf			
F. Soils requiring site response analysis	See Section 20.3.1		
For SI: 1 ft./s = 0.3048 m/s; 1 lb./ft ² = 0.0479 kN/m ² .			

7 DEPENDENCE OF TYPICAL SOLUTIONS ON CLIMATIC ZONES OF THE USA

7.1 General

7.1.1 Weather in the USA: Climate

Due to the size of the country, its long duration and the wide variety of geographical features on the territory of America, areas with almost each climatic characteristic are represented. Nevertheless, at the same time, most of the country (states north of 40 degrees north latitude) is located in a temperate zone, while the subtropical climate prevails south of the state of Hawaii and the southern part of Florida lie in the tropics, and the north of Alaska belongs to the polar regions. The great plains located on the west of the 100th meridian belong to the semi-deserts, the Great Basin and the areas around it are arid, and the coastal regions of the State of California are a Mediterranean climate. It is interesting to note that the type of climate within the boundaries of one belt varies significantly depending on the relief, proximity of the ocean and other factors. A favorable climate, at one time, had a considerable influence on the settling of the continent by Europeans.

7.1.2 Weather in the USA: Types of climate

As noted above, almost all the existing climatic zones are located in the USA. Typical types of climate:

- tropical (Hawaii),
- temperate and subtropical (Pacific coast),
- continental marine (coast of the Atlantic Ocean),
- continental (internal plateaus and plateau of the Cordillera),
- arctic (central and southern parts of Alaska).

Figure 7.1 shows the climate zones for United States Locations according to the location.

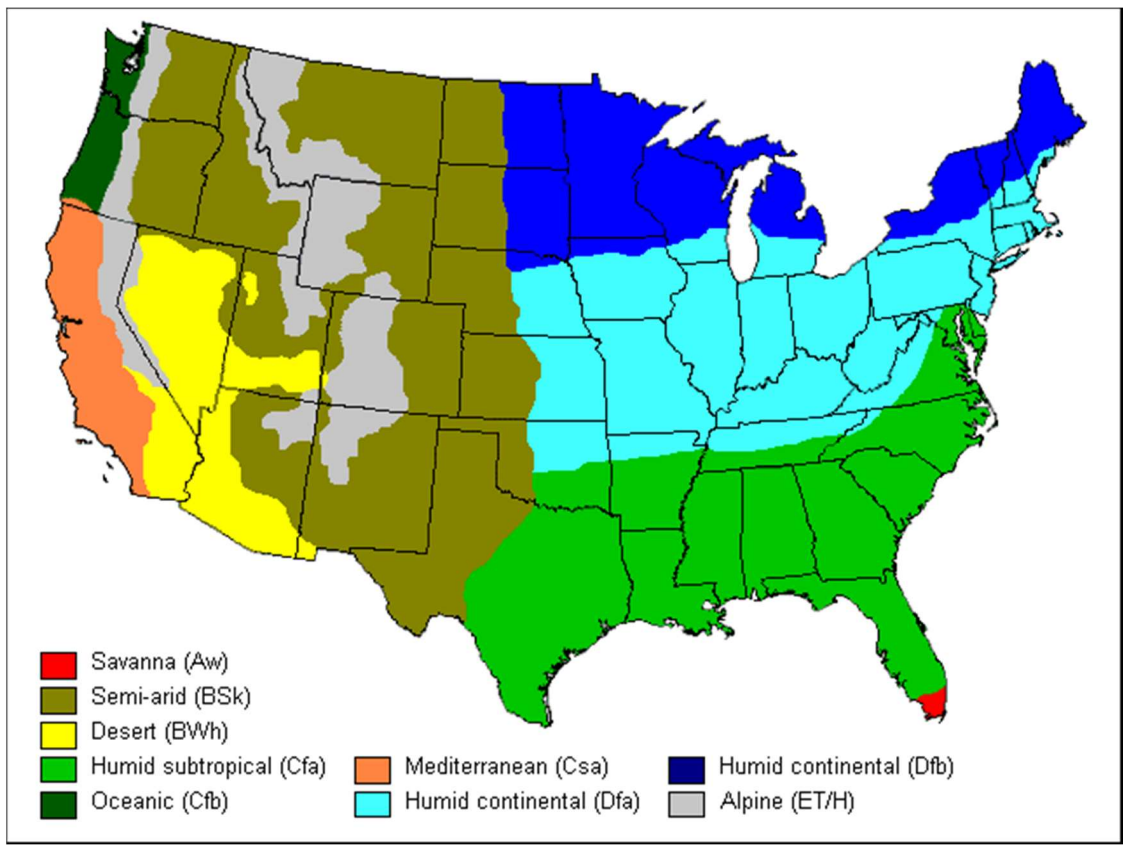
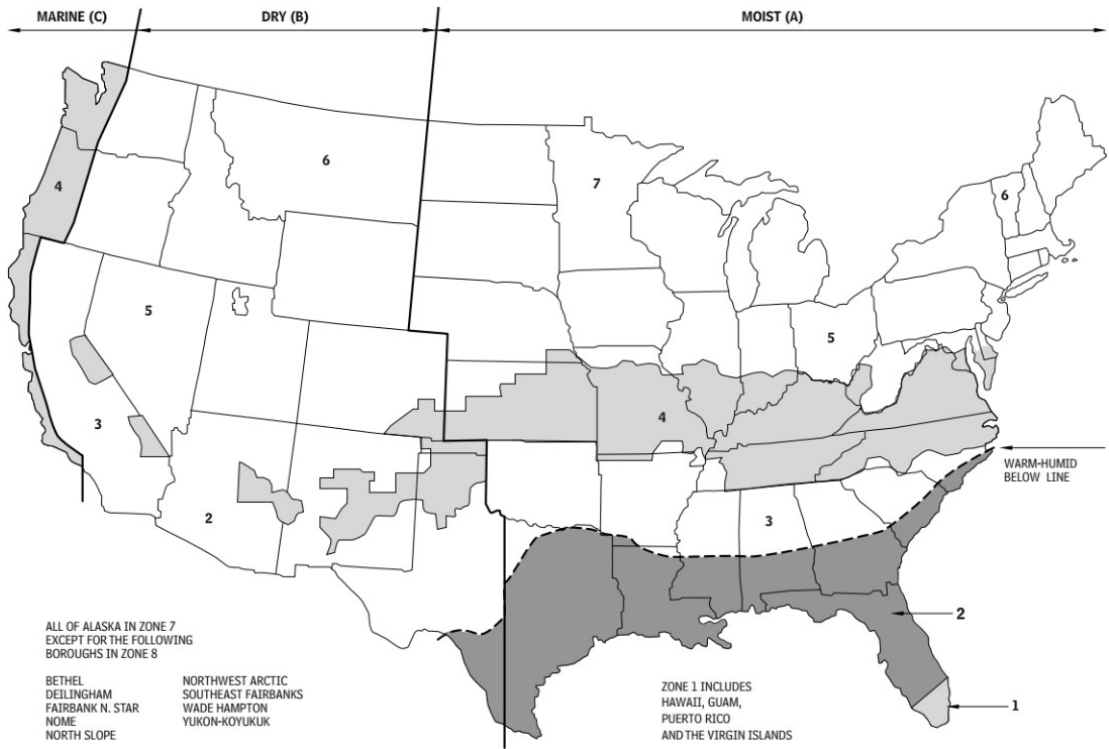

Figure 7.1. Climate zones for United States Locations (1, p. 26)

7.2 Wall design according to the climate zone

7.2.1 Wall structure for all climate types

- Highly reliable cabinet system for controlling HAM in all climatic conditions of the zones, not relying on the creation of mechanical systems for drying indoor air.
- Thermal insulation, located outside the structure and facing the walls. It is easy to install continuous air barriers and vapor retarders.
- Thermal insulation must be continuous to prevent the steam retarder from reaching the dew point.
- Excellent choice for CMU cladding or metal pins backup system. If metal stud backup systems are used, do not install thermal insulation between the studs.
- Any paint or wall covering can be used for interior finishing.

Figure 7.2 presents the example of the common wall used in the all climates in the US.

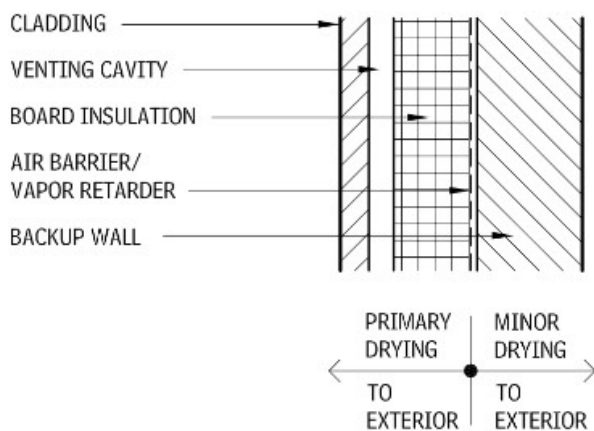

Figure 7.2. All climates wall design (1, p. 28)

7.2.2 Hot climate (Zones 1, 2 and 3)

- The mechanical system must ensure that the internal air is to be dried.
- Avoid any vapor impermeable internal surfaces (for example, a vinyl wall covering that catches moisture).
- A radiant barrier can be inserted into the cavity.

- Film sheath connections, insulation or combination of sides can provide an air barrier.
- The air barrier is critical to limiting the transfer of moisture through imperfections in the steam moderator.

Another example is shown in Figure 7.3, type of structure for hot and humid climates.

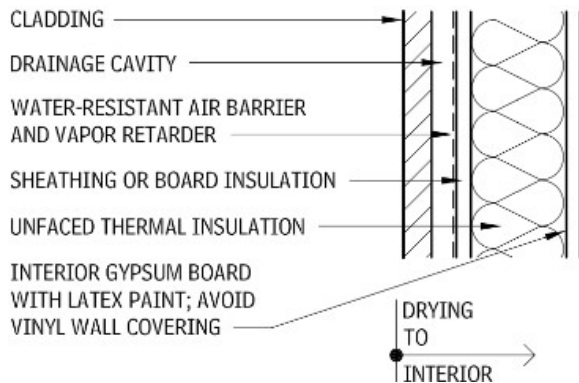

Figure 7.3. Hot, humid climates wall design (1, p. 28)

7.2.3 Cold climate (Zones 5 to 8)

- Materials should be more permeable, as they are closer to the outside face.
- Any paint or wall covering can be used for interior finishing.
- A mechanical system is not required to dry indoor air.
- A malfunction of the construction paper can lead to accumulation of moisture, which cannot be overcome by drying.
- Elements that penetrate the thermal insulation (for example, beams supporting the projection of an awning or a pallet for a roof pan) can cause condensation problems if they are not insulated with closed cell insulation or heat insulation with retarder vapor to prevent moisture from entering these surfaces. This is especially true for people with high humidity, (including residences, hospitals, museums, swimming pools).

Figure 7.4 shows the types of wall used in cold climates.

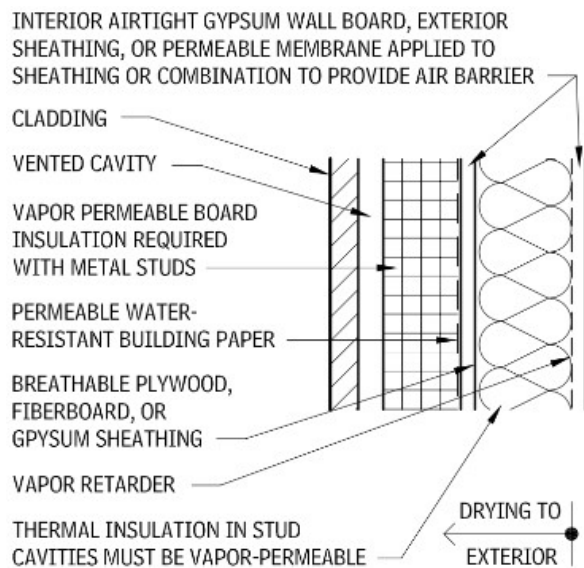

Figure 7.4. Cold climates wall design (1, p. 28)

7.2.4 Mixed climate (Zones 3 and 4)

- All materials must be relatively vapor permeable for drying in both directions, because the seasons change the direction of heating of the stream and steam.
- Detailed system with internal and external lateral permeable air barriers to limit moisture transfer and infiltration / extra filtration.
- It is possible to use an insulating board with ribbon connections, like a shell that forms a vapor retarder if the board and blanket insulation has approximately the same U-value.

The shell of the building must have its own measure of integrated thermal protection. A designer shall be informed of methodological capabilities to quickly define which of the designs has led to the deterioration of the complex characteristic and how much a structure needs to be "duttet". Building thermal envelope shall meet the requirements of Table 7.1. Minimum thermal resistance (R-value) of the insulation material installed either between the roof framing or continuously along the roof assembly shall be (as specified in Table 7.1) based on construction materials used in the roof assembly. Building envelope requirements are based on the climate zones where the building shall be built. Depending on the building destination there are requirements for roofs, walls, slab-on-grade floors, opaque doors.

Table 7.1: Building envelope requirements – opaque assemblies (27, Chapter 5)

CLIMATE ZONE	1	2	3	4 except Marine	5 and Marine 4	6	7	8
Roofs								
Insulation entirely above deck	R-15 ci	R-15 ci	R-15 ci	R-15 ci	R-20 ci	R-20 ci	R-25 ci	R-25 ci
Metal buildings (with R-5 thermal blocks ^a) ^b	R-19 + R-10	R-19	R-19	R-19	R-19	R-19	R-19 + R-10	R-19 + R-10
Attic and other	R-30	R-30	R-30	R-30	R-30	R-30	R-38	R-38
Walls, Above Grade								
Mass	NR	NR	R-5.7 ci ^{c, e}	R-5.7 ci ^c	R-7.6 ci	R-9.5 ci	R-11.4 ci	R-13.3 ci
Metal building ^b	R-13	R-13	R-13	R-13	R-13 + R-13	R-13 + R-13	R-13 + R-13	R-13 + R-13
Metal framed	R-13	R-13	R-13	R-13	R-13 + R-3.8 ci	R-13 + R-3.8 ci	R-13 + R-7.5 ci	R-13 + R-7.5 ci
Wood framed and other	R-13	R-13	R-13	R-13	R-13	R-13	R-13	R-13 + R-7.5 ci
Walls, Below Grade								
Below grade wall ^d	NR	NR	NR	NR	NR	NR	R-7.5 ci	R-7.5 ci
Floors								
Mass	NR	R-5 ci	R-5 ci	R-10 ci	R-10 ci	R-10 ci	R-15 ci	R-15 ci
Joist/Framing	NR	R-19	R-19	R-19	R-19	R-30	R-30	R-30
Slab-on-Grade Floors								
Unheated slabs	NR	NR	NR	NR	NR	NR	NR	R-10 for 24 in. below
Heated slabs	R-7.5 for 12 in. below	R-7.5 for 12 in. below	R-7.5 for 12 in. below	R-7.5 for 12 in. below	R-7.5 for 24 in. below	R-10 for 36 in. below	R-10 for 36 in. below	R-10 for 48 in. below
Opaque Doors								
Swinging	U – 0.70	U – 0.70	U – 0.70	U – 0.70	U – 0.70	U – 0.70	U – 0.70	U – 0.50
Roll-up or sliding	U – 1.45	U – 1.45	U – 1.45	U – 1.45	U – 1.45	U – 0.50	U – 0.50	U – 0.50

Figure 7.5 presents wall design mixed climates.

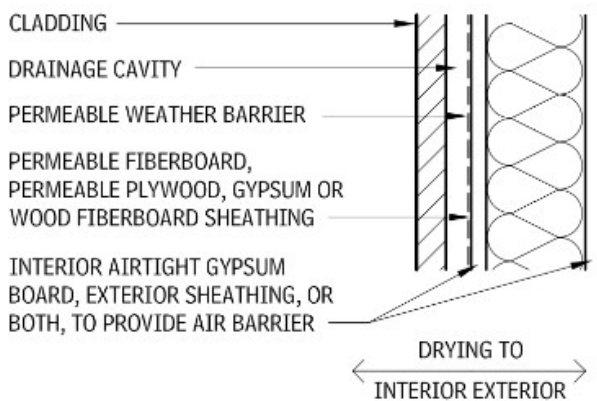

Figure 7.5. Mixed climates wall design (1, p. 28)

Table 7.2 shows the types of overlaps most common in industrial buildings with a steel frame.

Table 7.2: Floor structure assemblies

		Depth of assembly (in.)	Standard member sizes (in.)	Dead load of structure	Suitable live load range (psf)	Span range (ft)	Dimensional stability
Steel joist	Figure 7.6	9–31	Steel joists 8–30	8–20	30–40	16–40	Deflection
Steel joist	Figure 7.7	11–75	Steel joists 8–72	30–110	30–100	16–60 (up to 130)	Deflection
Lightweight steel frame	Figure 7.8	7–12	Consult manufacturers' literature	6–20	30–60	10–22	
Structural steel frame	Figure 7.9	9–15		35–60	30–100	16–35	Deflection
Structural steel frame	Figure 7.10	8–16	Precast Structural Concrete W4–48 W4–12 D	40–75	60–150	Up to 50; generally below 35	Deflection and creep

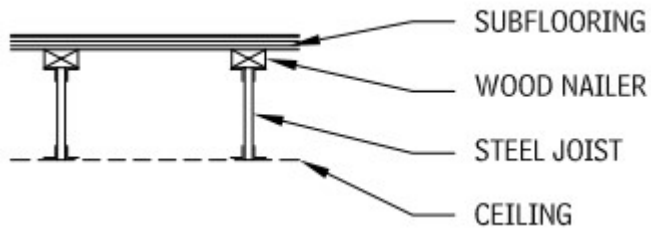

Figure 7.6. Steel joist (1, p. 30)

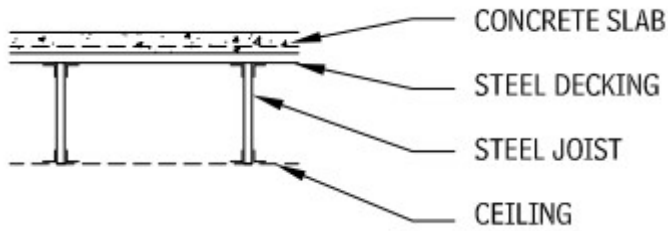

Figure 7.7. Steel joist (1, p. 30)

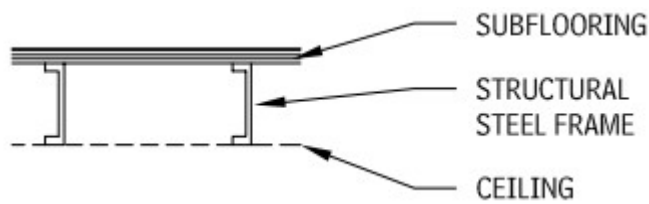

Figure 7.8. Lightweight steel frame (1, p. 30)

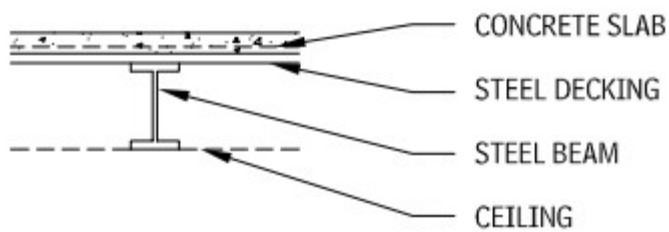

Figure 7.9. Structural steel frame (1, p. 30)

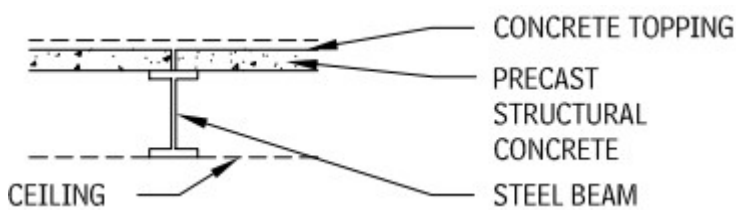

Figure 7.10. Structural steel frame (1, p. 30)

7.3 Insulated metal panel wall assemblies

Metal wall panels fall into two main categories: field and produced at the factory. Metal wall panels range from 4 to 15 feet, depending on the thickness of the metal, panel thickness and wind load. Finish on metal panels can be untreated galvanized sheet or any number various factory applications from baked enamel to highly effective polyvinylidene coatings (PVDF).

7.3.1 Field-assembled wall panels

In Figure 7.11 you can see the main parts of a typical insulated field-assembled wall panel.

The assembly order for these panels is as follows:

1. Metal facing panels are fixed on structural cuffs with self-preparation, self-tapping screws. Linear panels are typically 24 inches wide. The depth of the cladding panel is determined by the required insulation (2 to 4 inches).
2. Semi-liquid mineral wool insulation, located on the inner lining panel.
3. Bends are screwed to the flanges of the cladding panel.
4. External metal panels are screwed to the lining. External panels can be corrugated, standing seam, stand or formed in the form of a box. Fasteners that normally open, but hidden fasteners are available.

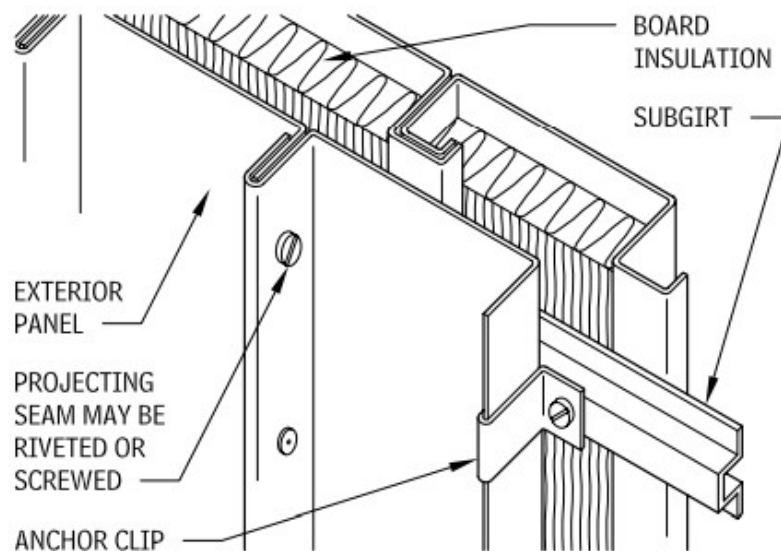

Figure 7.11. Typical insulated field-assembled wall panel (1, p. 108)

7.3.2 Factory-formed metal panels

Figure 7.12. shows factory-formed insulated metal panels.

Panels usually range from 24 to 36 inches in width, up to 40 feet in length, and 2 to 4 inches. Panels are made by either laminating inner and outer sheath of sheet metal for rigid insulation or injecting an expanding foam between the two skins. Panels can be oriented horizontally or vertically and are available in large quantities profiles. Horizontally oriented panels provide a design in the style of rain joints.

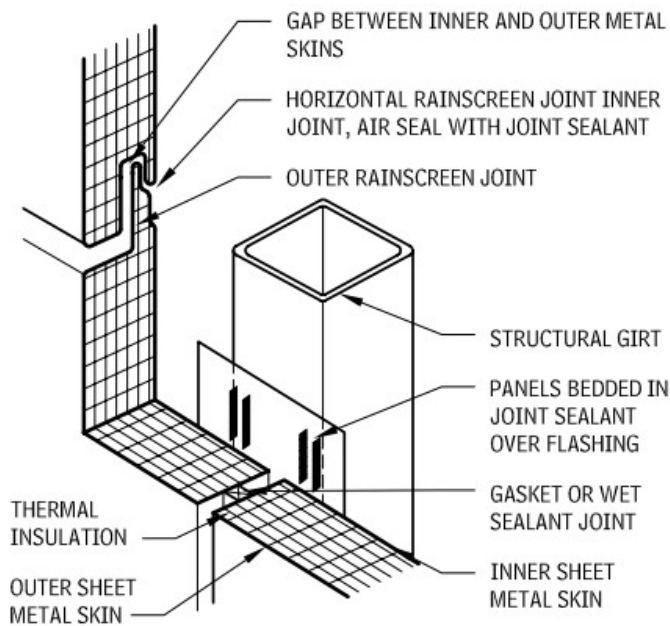

Figure 7.12. Factory-formed insulated metal panels (1, p. 108)

For example, consider fastening of wall panels to a metal frame. Figure 7.13 shows the basic components of the construction of external walls. They are typical in such buildings.

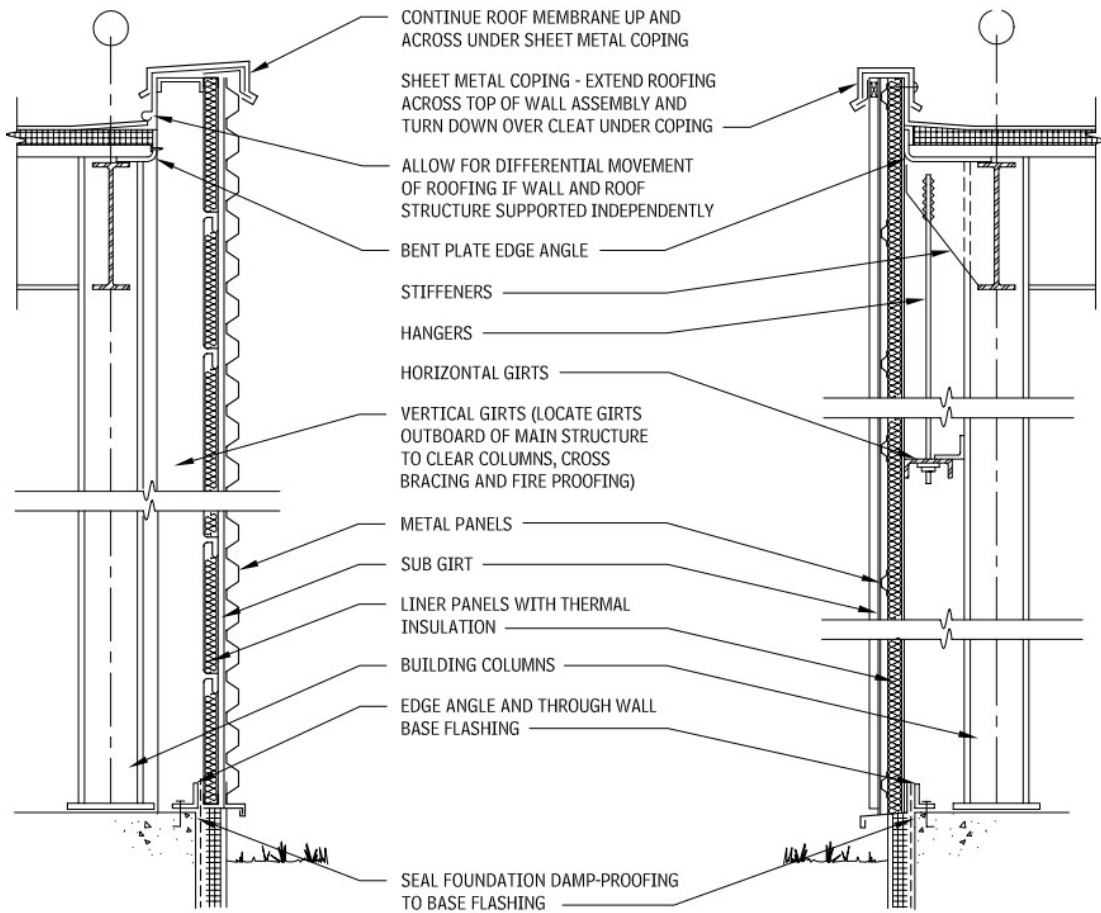

Figure 7.13. Typical section of the wall panel when fastened with a steel frame (1, p. 108)

8 DRAWINGS

The method of forming projections and their placement on the drawing, which we use, is called European. The American method differs significantly from the European one. In most countries of the world, the drawings are made according to European rules or very close to them. An experienced person, having received a drawing executed in the United States, on its design will determine the origin of the document and sort it out.

The basic rules that need to be followed when designing drawings are shown in Table 8.2.

Table 8.2: List of rules for designing of the drawing

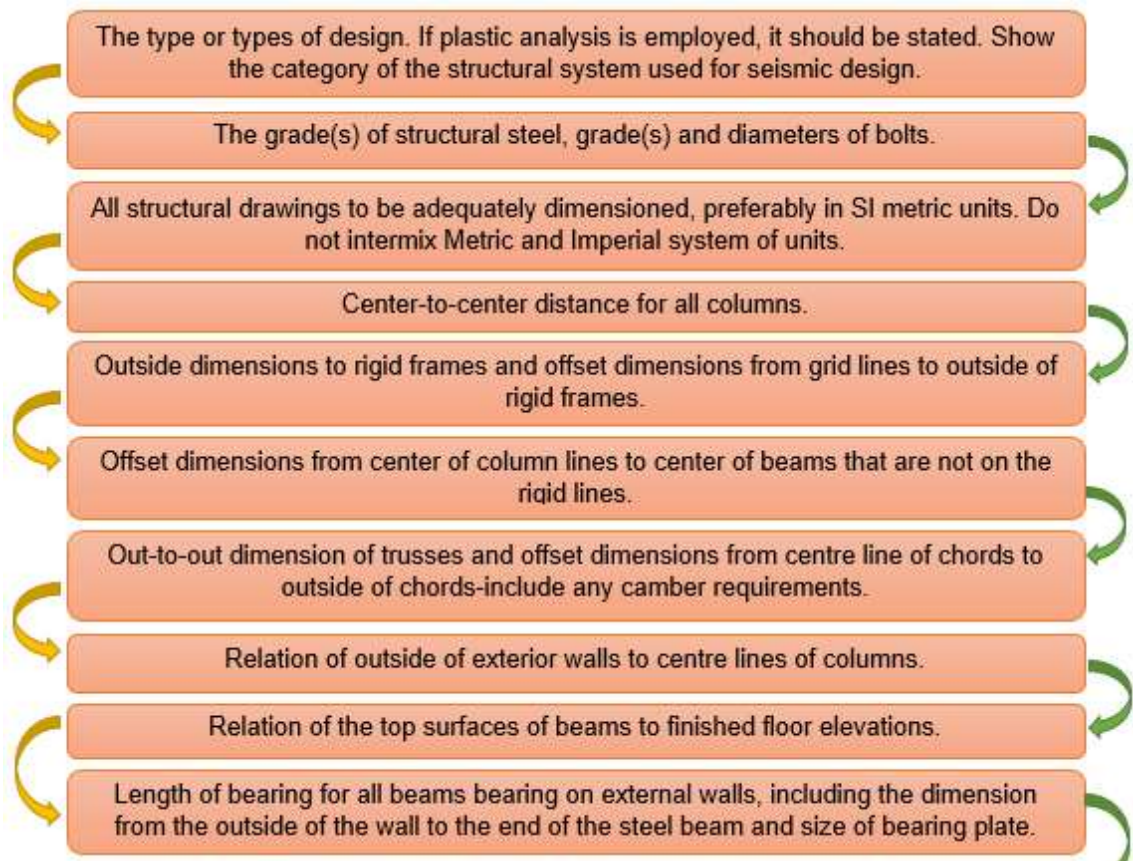

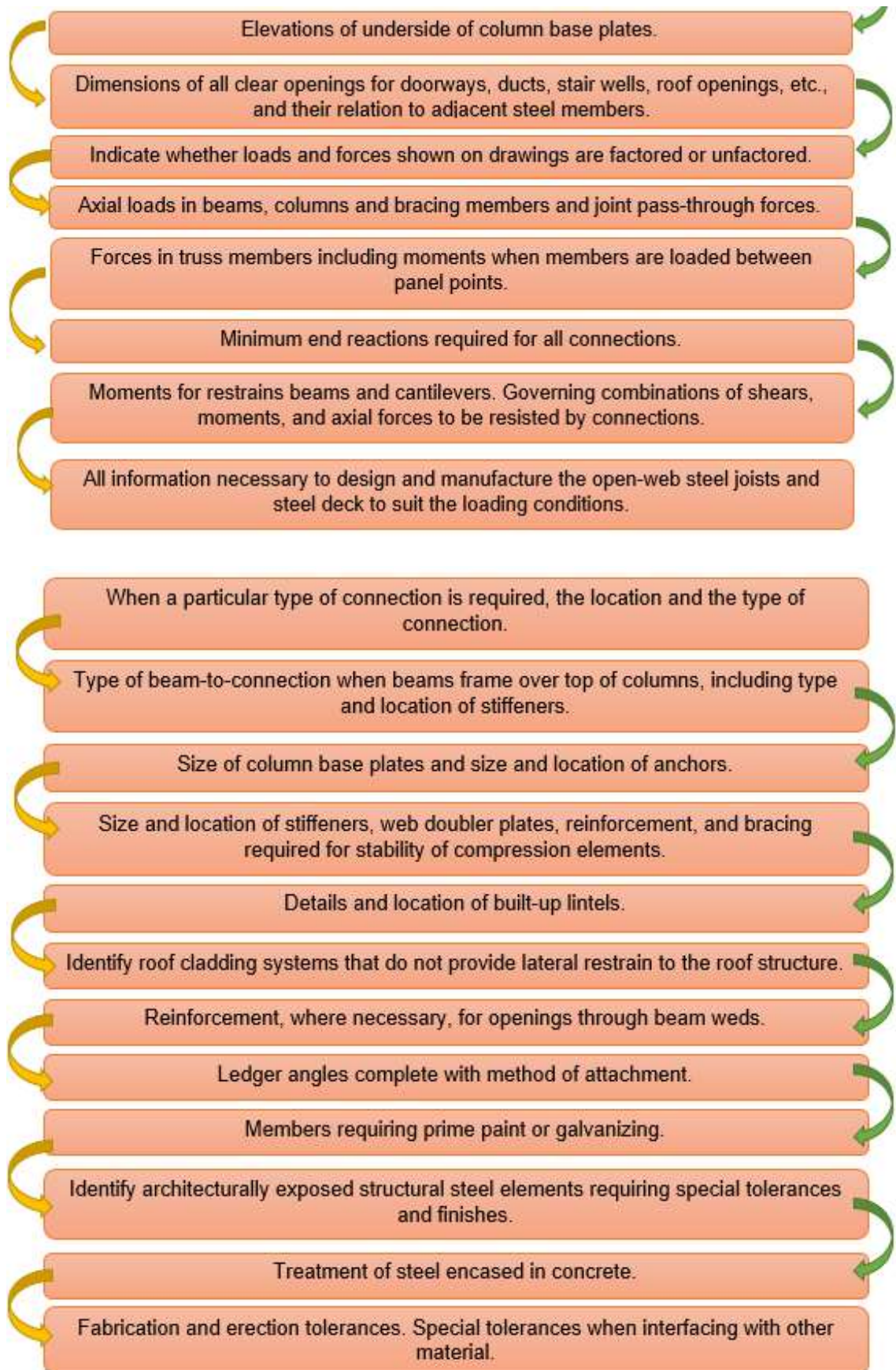

9 MOST POPULAR PROGRAMS IN THE UNITED STATES FOR THE DESIGN OF INDUSTRIAL BUILDINGS

9.1 S-frame

Developing links using the application-programming interface Tekla API includes writing code to connect to an open in the Tekla model and query or manipulate the model. In this case, the communication was developed using the S-Frame and Tekla application programming interfaces. To manage the elements transferred between Tekla Structures and S-Frame, the library database is used.

In general, the process includes the following steps: import into S-Frame, display imported items and export from S-Frame.

9.2 Tekla Tedds 2016

The new version of Tekla Tedds, a solution for automating repetitive settlement calculations, is complemented by functions in accordance with the wishes of customers. New functions provide greater flexibility and analysis and design capabilities for load-bearing walls, foundations and steel and concrete.

Trimble-Tekla-2016

Automatic calculations facilitate and accelerate the work, and allow users to avoid human errors in the calculation of loads. Templates of documents that can be brought into line with company standards, including custom layouts and logos, save time and improve the presentation quality. An example of correction with Tedds 2016 is shown in Figure 9.1.

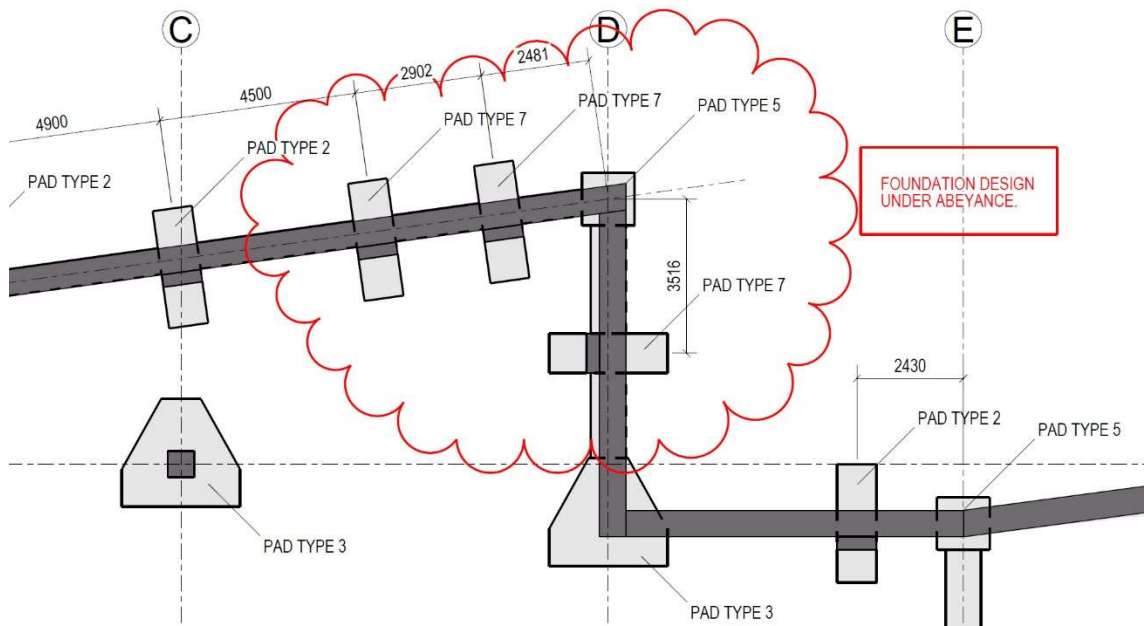

Figure 9.1. Comments example in Tedds 2016 (13)

9.3 Limcon

Limcom is used to design steel joints, this is the responsibility of the manufacturers. Thanks to the library of international standards, connection types save time and money, quickly develop connections and execute CAD drawings in one convenient application. You can easily check the results of the development of connections and quickly publish a short project report, which summarizes all the checks and connection states.

- Compliance with seismic requirements
- Design and detailing of the structure, taking into account seismic loads that meet construction standards. These forces are considered in detail in the design of the elements and, where applicable, the projected flat and bulk structures.
- Construction of structural steel joints
- Design and detailing of joints of metal structures, including beam connections, beam column, slices, anchors and complex multi-element connections. Simplify the arrangement of plates, stiffeners, bolts and welded joints using the full library of standard connection types. It is easy to compare the economics and practicality of various joint options.

- Design in accordance with international standards
- Registration of project documentation
- Automatically create documentation for building structures, including the necessary plans and sections that are used to convey the intentions of the project. Changes made to the three-dimensional model are automatically updated in the drawings.
- Development of elements of building structures
- Compile detailed 2D drawings directly from the results of the design model. Configure the style and format of the drawings using the options offered in the software.
- Verification on AISC 360, CSA S16, BS 5950, EC3, AS 4100, NZS 3404.
- SI is a metric or an American conventional unit.

An example of a detail modeled by Limcon is shown in Figure 9.2

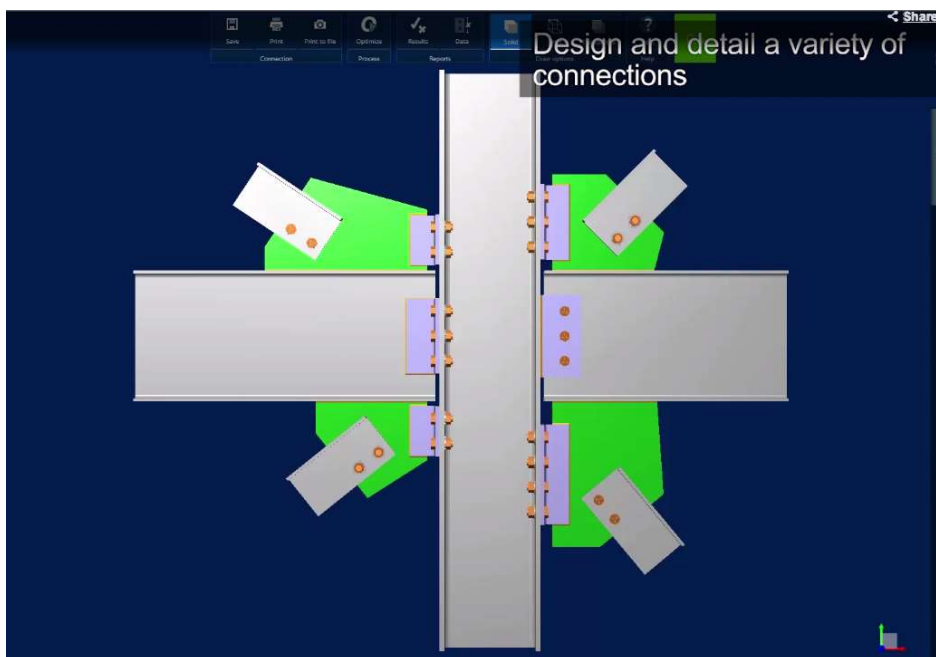

Figure 9.2. Detail of connection with software Limcon (12)

9.4 SPMat

SmartPlant Materials is a system for managing and administering materials for process plants. Its main applications are:

- Design, design and construction of oil refineries for the chemical, pharmaceutical and petroleum industries
- Construction of industrial pipelines
- Construction of a power station

Shipbuilding and assembly of the materials of SmartPlant support the management of materials in all disciplines, including pipelines (and pipe supports), structural steel devices and equipment (for example, vessels). SmartPlant's materials provide ongoing support at all stages of project management.

This support includes:

- Pre-project phase of parts and standards specifications
- Design and financial planning (Figure 9.3)
- Definition of material requirements
- Procurement and planning
- Pre-assembly and installation
- Time and cost of tracking

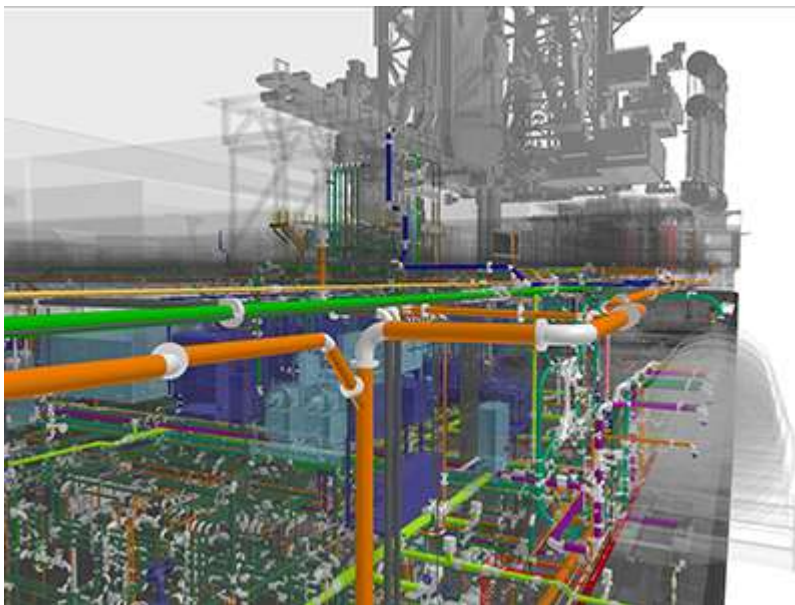

Figure 9.3. Structures of pipes at SPMat (11)

9.5 SAP2000

Model templates, convenient tools for creating and editing a model, and intuitive management make the modeling process in SAP2000 fast and comfortable. Modeling is object-oriented, which means that the user operates elements such as a rod, plate, body, while the program breaks down into finite elements independently. There are several methods of stakeout, including automatic. In addition, with a disconnected grid and the function combining edges, the program complex automatically connects the edges of adjacent elements and considers the construction to be a single entity, even if there are no common nodes in the elements.

In SAP2000, in addition to standard material and profile libraries, there is a built-in section constructor and a material editor. The section constructor allows you to create sections of any shape elements from any available materials and include them in the model. The material editor is used to create material models. It should be noted that the materials could be isotropic, orthotropic and anisotropic. It is possible to determine the dependence of deformation properties on temperature, stress-strain diagrams, and other properties.

The following types of linear calculations are available:

- static linear calculation;
- calculation of forms and frequencies of natural oscillations (Figure 9.4);
- calculation of natural frequencies by the Ritz method for implicitly determined problems;
- calculation of response spectra;
- linear dynamic modal calculation with development in time;
- linear dynamic calculation by the method of direct integration with development in time;
- calculation of amplitude-frequency characteristics;
- spectral density analysis;
- calculation of stability (linear formulation).

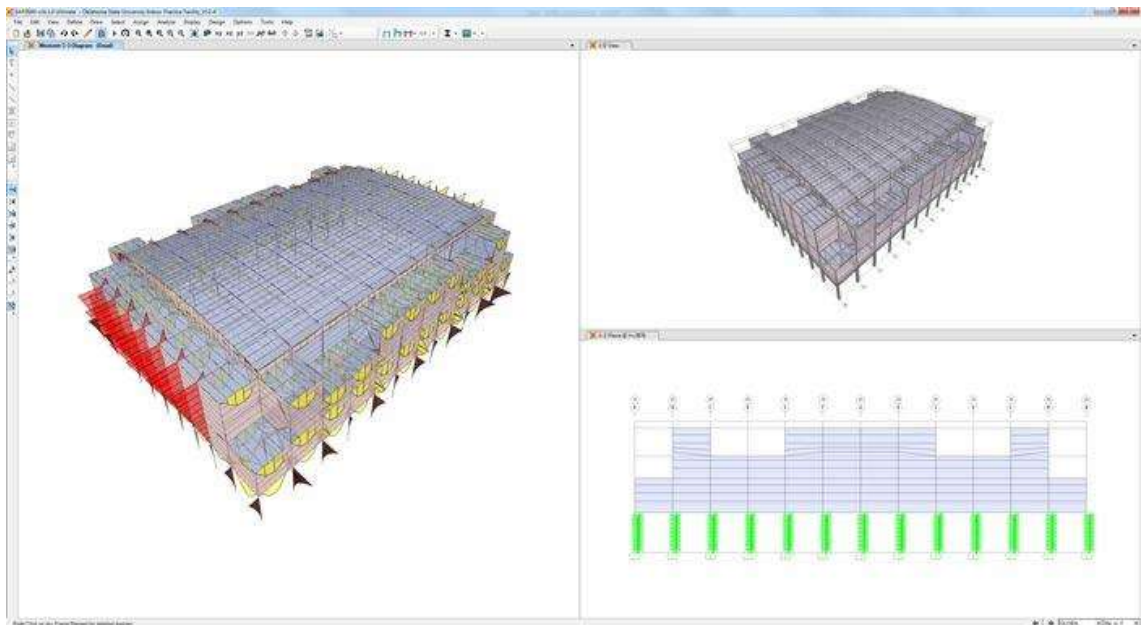

Figure 9.4. Calculation of loaded structures (10)

9.6 Navisworks

Similar to the transition from paper to CAD, users face much greater opportunities when switching from CAD to BIM than simply reduces errors and increases productivity.

There are special names for models containing additional data:

4D - three-dimensional BIM-model with information on the timing or cost of construction

5D - the same, only the data is about the timing, and the cost

To work with the model at this level, Autodesk has a special product - Autodesk Navisworks. The program allows you to collect together a large number of different data (including from "non-Autodesk" applications), and very quickly work with them.

In the list of basic opportunities:

- assemble large amounts of data and efficient work with them
- check for intersections (unlike Revit, support for conflict statuses, pre-notes, assignments of responsible persons, and much more)

- analysis of geometric characteristics with the help of an avatar (known to many "walking a little man")
- addition of calendar schedules of construction (design and actual), visualization of construction (4D)
- in the Navisworks 2013 version - cost accounting (5D)
- connecting databases to object properties
- obtain visualization, video files

In the USA they use Autocad Smartplant. Engineers then create a global model in Navisworks (civil, mech, piping, elec.). Sometimes clients get their navismodels in order to get quick access to entire project. BIM gives all parties an access to a model, including the fabricator and erector and they may modify it as well.

BIM models are very useful in the pre-project stage. They contribute in better connection between a client and a designer group. Superintendents use models to control the situation on the site. Currently the USA is one of the leading countries in the use of BIM technology in the engineering industry.

10 PROJECT AT SITE

Most of the building standards across the United States are very similar and they were formed as a result of many years of practice and tough competition of builders, manufacturers of building materials, developers, and also largely take into account the local climatic characteristics, national characteristics of the majority of local residents. For example, in Miami it is forbidden to build basements (frequent storms and storms flood them), in some cities and even states it is forbidden to use plastic windows (PWC Windows), install Siding, install wooden fireplaces (Woodburn Fireplace), install a centralized sewage system or water supply. In many cities, the maximum height of buildings, the width of roads, sidewalks, the capacity of built-in garages, the ratio of the area of the house spot to the total area of the plot, the distance between the buildings, the comprehensible electrical power, the distance from the house to the public road, etc. are legislatively fixed. Many cities prohibit the installation of fences, outdoor lighting, and the use a water pipe for watering lawns. Many cities tightly limit the maximum size of the area of houses, and used construction (especially outdoor) materials. Strong enough in recent years have become requirements for thermal insulation of buildings.

The construction department of the local municipality carries out construction supervision. In their person, state architectural construction supervision is carried out. The control begins with the coordination of the project documentation (takes from 2 to 12 months), issuance of the site plan. During construction, the inspector will come to you no more than 4-5 times, only to take hidden work and upon completion of construction. The most important building control is the representative of the creditor bank. If the controller finds errors that are critical to home security, he can (and does) stop the construction with a written injunction to fix the violations.

All the works and their results must necessarily comply with the technical regulations, approved projects, engineering survey data. Construction control in construction is:

- implementation of management of construction processes;
- quality inspection of supplied building materials, tools and components

- implementation of acceptance measures;
- maintenance of all documentation accompanying construction work.

During long-term construction a large number of modifications may occur in a project, caused by financial or technical reasons. According to the requirements of construction supervision, all changes introduced should not adversely affect the safety of the erected building.

Table 10.1: Requirements for building control

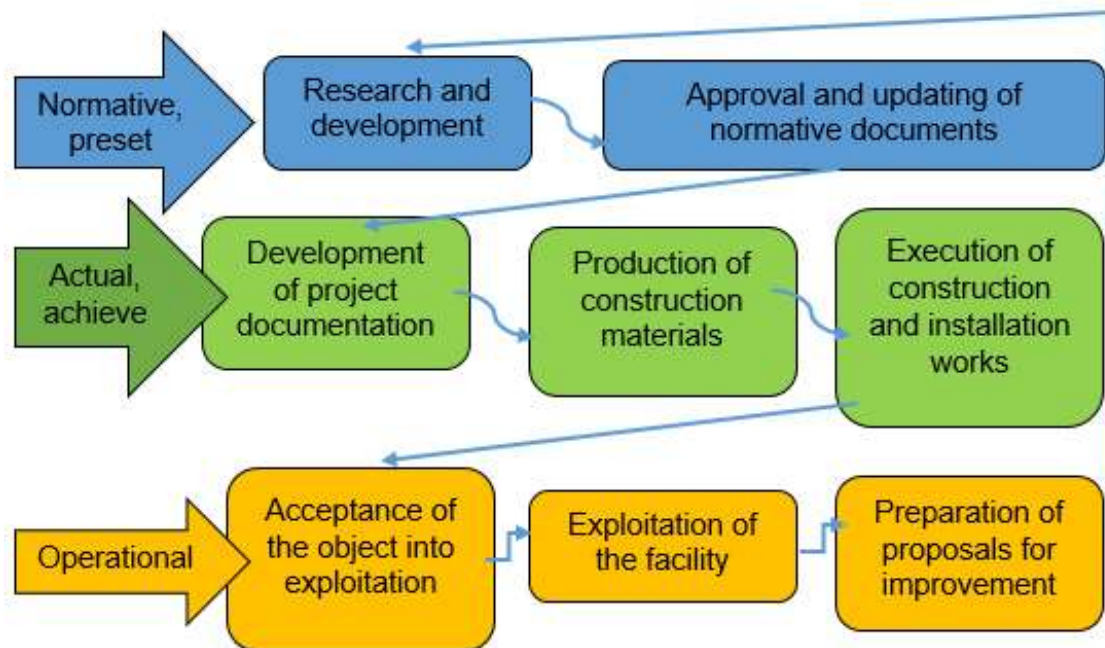

Without exception, all construction, carried out at the expense of the local budget, is made only by winners of an open tender for a contract.

For many types of construction work it is necessary to obtain a construction license from a local authority (architecture, plumbing, electricians, ventilation, roofing works, mechanization, improvement, concrete works, external utilities, roads, removal and disposal of construction debris, etc.)

Most US cities have long-term development plans and clear zoning for low-rise, multi-storey buildings, industrial and recreational areas, waste disposal areas, trade areas, public parking and transportation, etc. The planning is based on long-term forecasts of economic development and financing opportunities. All plans have substantial financial and technological background.

One of the positive experiences of the US is the implementation of a qualification policy that provides for the reservation of federal projects for contracting firms that allocate funds for research and implementation of new technology, which are a division of risks between governments and contractors that develop and use estimates.

CONCLUSION

The topic considered is in demand at the moment. One of the main difficulties is a different measurement system. It takes time to adapt and acquire a constant recalculation of sizes, from the methodical measurement system that we are familiar with. In addition, great attention shall be definitely given to regulatory documentation of the design of industrial buildings in the US. In order to conduct the project, it is significant to have specialists with the appropriate amount of experience in the calculation of load-bearing structures and design features according to the US standards. Due to the fact that there is no single normative document in the United States, it is necessary to fully follow all recommendations and norms.

As it was already mentioned, the norms themselves are not mandatory, but the customer and insurance companies prescribe their necessary use. Moreover, while designing, it is necessary to pay attention to climatic zones, since the building temperature regime depends on its influence. It is worth repeating that for a framework solution it is typical to use a steel frame. This has both technical justification and the impact of the labor market. For the customer it is more profitable to hire subcontractors for the implementation of metal frames. It is more beneficial for the cost of the work performed, as well as it increases the speed of structure erection and ease of installation work in comparison with the reinforced concrete frame. To sum up the great role of practical experience is a vital factor.

Undoubtedly not diminishing the importance of theoretical understanding it is substantial to own considerable experience obtained through participation in a number of projects in order to fully comprehend the design features of the industrial buildings in the US.

Having considered only some aspects of design in the United States, it is worth noting that in the future it is essential to pay great attention to the calculations of the structures. Experience of a designer is of great importance. As well as it is substantial to carefully collect all the possible loads, to select a constructive

scheme and to select materials. Calculations must be carried out in accordance with corresponding regulations.

Design is a unique link between science and production, between the scientific and technical justification of the project, its pre-design research and construction and installation works. Modern technologies and techniques shall be considered while design to a great extent. In addition, during design stage construction effectiveness shall be defined, which demonstrates the balance between time, cost and quality. Moreover, the design stage shall estimate all the possible social benefits of the project.

Literacy of constructive decisions effects construction time, labor intensity and metal consumption of the erected object. Successful construction decisions increase competitiveness of the manufactured product.

At the moment it is difficult to predict which shares European companies might gain in the US construction market. Nevertheless, it is true to say that European companies working within the US entrust design of local projects to European engineers despite the strict US regulations.

FIGURES

- Figure 2.1. Use of Model Building Codes in the United States, p.10
- Figure 2.2. ANSI/AISC 360-16, p.15
- Figure 2.3. ASCE/SEI 7-16, p.15
- Figure 3.1. The opposition of the system of measuring in the United States to the whole world, p.16
- Figure 3.2. Metric conversion card according to NIST, p.19
- Figure 4 Construction organization chart USA, p.21
- Figure 4.1 Gilberd smith forest products, p.25
- Figure 4.2 Babine forest production, p.25
- Figure 4.3. Old steel frame building in the US, p.26
- Figure 4.4 Footing minimum dimensional requirements, p.29
- Figure 4.5. Spread footing-steel column, p.30
- Figure 4.6. Timber and steel piles, p.31
- Figure 4.7 Composite piles, p.31
- Figure 4.8 Concrete piles part 1, p.31
- Figure 4.9 Concrete piles part 2, p.32
- Figure 4.10. Four corners profile, p.32
- Figure 4.11 Four corners profile with steel strips, p.33
- Figure 4.12. Four corners profile, p.33
- Figure 4.13. Cross bracing, p.37
- Figure 4.14. Portal bracing, p.38
- Figure 4.15. Pitched truss 1, p.38
- Figure 4.16. Pitched truss 2, p.39
- Figure 4.17. Bracing arrangement 1, p.39
- Figure 4.18. Bracing arrangement 2, p.40
- Figure 4.19 Detailing to minimize corrosion, p.41
- Figure 5.1. Basic Concept of Safety in LRFD and ASD Considering the Variability of Loads and Resistance, p.47
- Figure 6.1. Exposure B Example, p.56
- Figure 6.2. Exposure C Example, p.56
- Figure 6.3. Topographic Factor, Kzt, p.59
- Figure 6.4 Ground Snow Loads, Pg, for the United States (Lb/Ft2), p.61
- Figure 6.5 Roof shapes and snow load coefficients for flat, shed, gable, hip, arch roofs, p.62
- Figure 6.6 Roof shapes and snow load coefficients for valley areas of 2-span, multi span slope, curved, lower and multi-level roofs, p.63
- Figure 6.7. Shape coefficients for the following types of roofs according to EN 1991-1-3, p.64
- Figure 7.1. Climate zones for United States Locations, p.68
- Figure 7.2. All climates wall design, p.69
- Figure 7.3. Hot, humid climates wall design, p.70
- Figure 7.4. Cold climates wall design, p.71
- Figure 7.5. Mixed climates wall design, p.72
- Figure 7.6. Steel joist, p.74
- Figure 7.7. Steel joist, p.74
- Figure 7.8. Lightweight steel frame, p.74
- Figure 7.9. Structural steel frame, p.74
- Figure 7.10. Structural steel frame, p.74

- Figure 7.11. Typical insulated field-assembled wall panel, p.75
Figure 7.12. Factory-formed insulated metal panels, p.76
Figure 7.13. Typical section of the wall panel when fastened with a steel frame, p.77
Figure 9.1. Comments example in Tedds 2016, p.81
Figure 9.2. Detail of connection with software Limcon, p.82
Figure 9.3. Structures of pipes at SPMat, p.83
Figure 9.4. Calculation of loaded structures, p.85

TABLES

Table 4.1: Comparison of I-beams, p.35

Table 4.2: IPE beams with parallel flange according to Euronorm 19-57, p. 35

Table 4.3: Wide Flange Beams according to ASTM A6 / A6M – 17, p.36

Table 5.1: Building Loads Categorized by Orientation, p.42

Table 5.2: Effect of Safety Factor on Level of Safety in ASD for a Typical Hurricane-Prone Wind Climate, p.45

Table 5.3: LRFD and ASD load combinations, according to ASCE 7-10, p.48

Table 6.1: Comparison of variable action intensities in different studied codes, p.52

Table 6.2: Risk Category of Buildings and Other Structures for Flood, Wind, Snow, Earthquake, and Ice Loads, p.54

Table 6.3: Importance Factor, p.57

Table 6.4: Topographic Multipliers for Exposure C, p.58

Table 6.5: Importance Factors by Risk Category of Buildings and Other Structures for Snow, Ice, and Earthquake Loads, p.60

Table 6.6: Meaning of Seismic Design Category, p.64

Table 6.7: Seismic Design Category Based on Short Period Response Acceleration Parameter, p.65

Table 6.8: Site Classification, p.66

Table 7.1: Building envelope requirements – opaque assemblies, p.72

Table 7.2: Floor structure assemblies, p.73

Table 8.2: List of rules for designing of the drawing, p.78

Table 10.1: Requirements for building control, p.88

REFERENCES

1. The American Institute of Architects. 2008. Architectural Graphic Standards. Published By John Wiley & Sons, Inc., Hoboken, New Jersey.
2. Minimum Design Loads for Buildings and Other Structures (ASCE 7-10). Reston, Virginia: American Society of Civil Engineers; 2010.
3. American Institute of Steel Construction. 2016. Specification for Structural Steel Buildings. Chicago
4. American Institute of Steel Construction, Inc. 2005. Seismic Provisions for Structural Steel Buildings. Chicago
5. R.A. Hawileh, F. Malhas, A. Rahman. Comparison between ACI 318-05 and Eurocode 2 in flexural concrete design. Struct Eng Mech (2009), pp. 705-724
6. American Concrete Institute. 2014. Building Code Requirements for Structural Concrete and Commentary. Farmington Hills
7. American Institute of Steel Construction, Inc. 2016. Code of Standard Practice for Steel Buildings and Briges. Chicago
8. American Society of Civil Engineers. 2003. Design Loads on Structures during Construction Standard – Background. San Diego, California, United States
9. National Insitute of Standards and Technology. 2006. The International System of Units (SI) – Conversion Factors for General Use. Publication 1038. Gaithersburg
10. SAP2000. Software for CSI. <https://www.csiamerica.com/products/sap2000> (Accessed on 29 October 2017)
11. SmartPlant Materials. User Interface Basics . <https://matermetal.files.wordpress.com/2014/03/spmat-user-interface-basics.pdf> (Accessed on 5 November 2017)
12. Limcon. Manuals. <http://strucsoftsolutions.com/limcon/> (Accessed on 8 November 2017)
13. Tekla Tedds 2016 software release. <https://www.tekla.com/products/tekla-tedds> (Accessed on 2 November 2017)
14. S-frame. Tekla User Assistance. https://teklastructures.support.tekla.com/2017i/en/int_sframe (Accessed on 2 November 2017)
15. Lin Z., Huang Z., 2016. Comparative Design of Structures. Introduction to Structural Design. Shanghai Jiao Tong University, China
16. Hammurabi's code of laws (adapted from the L.W. King translation). <http://iws.collin.edu/mbailey/hammurabi's%20laws.htm> (Accessed on 13 October 2017)

17. Climate of the United States.
https://en.wikipedia.org/wiki/Climate_of_the_United_States (Accessed on 19 October 2017)
18. Fedeski J., Fedeski M. 2001. Adapting Building Construction to the Effects of Climate Change. Welsh School of Architecture, Cardiff University, United Kindom.
19. Lausts J., 2008. International Energy Agency, Energy Efficiency Requirements In Building Codes, Energy Efficiency Policies for New Buildings. France
20. Bernuzzi C, Cordova B., 2016. Structural Steel Design to Eurocode 3 and ASIC Specifications. United Kindom
21. NAHB Research Center, Inc. 2000. Residential Structural Design Guide: 2000 Edition. Upper Marlboro, Maryland
22. Stratton M., 2000. Industrial Buildings, Conservation and Regeneration, New York
23. Coordinating Committee on the nomenclature of iron and steel products, 1957. Euronorm 19-57.
24. James M. A Overview of Fire Protection in Buildings.
https://mafiadoc.com/a-overview-of-fire-protection-in-buildings-federal-emergency-_59ce9b9a1723dd80fff49f82.html (Accessed on 18 October 2017)
25. Comparison of cross-section classifications. Topkaya C. 2011. A Comparative Study of AISC-360 and EC3 Strength Limit States. Department of Civil Engineering, Middle East Technical University,06531, Ankara, Turkey
26. Building seismic safety council National institute of building sciences. 2004. NEHRP recommended provisions (national earthquake hazards reduction program) for seismic regulations for new buildings and other structures (fema 450). Washington, D.C.
27. International code council, inc. 2006. International energy conservation code. U.S.A.
28. EN 1992-1-1, Eurocode 2. Design of concrete structures. General rules and rules for building. London: British Standards Institution; 2004
29. Building Code Requirements for Reinforced Concrete (ACI 318-14). Detroit, Michigan: American Concrete Institute; 2014.
30. EN 1991-1. Eurocode 1. Basis of design and actions on structures. London: British Standards Institution; 1996.
31. EN 1993-1-3, Eurocode 3. Design of steel structures – Part 1. 1: general rules and rules for buildings. London: British Standards Institution; 2001.
32. EN 1994-1-1, Eurocode 4. Design of composite steel and concrete structures – Part 1. 1: general rules and rules for buildings. London: British Standards Institution; 2004.

33. Structural Engineers Association of Arizona. 2007. Snow load data for Arizona. Arizona State University.
34. Wang, Y.C., and Kodur, V.K.R. 2000. "Research Towards the Use of Unprotected Steel Structures," ASCE Journal of Structural Engineering. Vol. 126, December.
35. Kodur, V.K.R., and Lie, T.T. 1995. "Fire Performance of Concrete-Filled Steel Columns," Journal of Fire Protection Engineering, Vol. 7.
36. ASTM. 2000. Standard Test Methods for Fire Tests of Building Construction and Materials, ASTM E119, American Society for Testing and Materials, West Conshohocken, PA.
37. Corrosion protection of structural steel. <http://bsbgltd.com/blog/a-guide-to-the-corrosion-protection-of-structural-steel-2/> (Accessed on 21 October 2017)
38. National Society of Professional Engineers. What is PE. <https://www.nspe.org/> (Accessed on 26 October 2017)
39. Why hasn't the U.S. adopted the metric system? <https://www.popsci.com/why-hasnt-us-adopted-metric-system> (Accessed on 9 October 2017)
40. Abandoned America (Accessed on 15 November 2017) <https://www.abandonedamerica.us/business-and-industry> (Accessed on 24 October 2017)
41. Типы поперечного сечения колонн <http://www.arhplan.ru/components/column/types-of-cross-section-columns> (Accessed on 25 October 2017)

So why is America still your other standard?

In 1789, Thomas Jefferson was the first person who tried to transform the nation into a denary system. However, behind the support of researchers, his idea failed.

The telephone artificer Alexander Graham Bell in 1906 told Congress that "some people have an adequate concept of the quantity of needless labor associated with the use of our current weights and measures." Powerful words, but so far no modifications.

Congress commissioned a 3-year research, which, ultimately, was proposed to be transformed into a metric and developed a ten-year strategy to get there, in 1968. However, they did not create an obligatory shift. Rather, business holders and people who resisted a large globalization and government and who saw the transformation as obedient leadership won the militant for minds and hearts. The Gallup vote at the time indicated that 45% of Americans were confronted with a switch.

Even now there are almost the same issues with the metric system. The advantages of switching are insignificant, but the expenses are enormous. Producers need to transfer the values on the packaging. Every day people would have to substitute their measures, shift to metric keys, spend time, find out what it means to say it is 20 degrees Celsius.

"As each educated people, we want to suppose that it makes sense to go metrically," said Donald Hillger, who is the president of the US Metric Sciences Association. "Now when I look at this and I think:" What precisely will I get from it? I will be irritated. "

Nevertheless, metric creep is again here. People buy machine parts in millimeters and gauge medicaments in milligrams, milk in liters. "This will happen," Hiller says, "but at the speed, we're going, it just needs some time."

Accordingly, in future it might be a play in inches.



Definitely, over time people begin to adapt. It seems quite simple to simply interpret some quantities in others. But this is one thing when we talk about everyday life and the other about the building. Tables 1 shows the main quantities used throughout the world to measure the length of account weight, and so on. The National Institute of Standards and Technology published a particular additions 1038. The publication contains recommendations on the use of the International System of Units to assure the use of weights and extents.

Table 1: Comparable Imperial / US Customary Units

	SI/Metric	Comparable Imperial/US Customary Units
Length	meter (m)	foot (ft) = 0.3048 m yard (yd) = 0.9144 m
	centimeter (cm) = 10^{-2} m	inch (in) = 2.54 cm
	kilometer (km) = 10^3 m	mile (mi) = 1.609 km
Area	square meter (m ²)	square foot (ft ²) = 0.0929 m ² square yard (yd ²) = 0.8361 m ²
	square centimeter (cm ²) = 10^{-4} m ²	square inch (in ²) = 6.452 cm ²
	hectare (ha) = 10^4 m ²	acre (A or ac) = 43,560 ft ² = 0.4047 ha.
	square kilometer (km ²) = 10^6 m ² = 100 ha	square mile (mi ²) = 640 A = 2.590 km ²
Volume	liter (l or L)	gallon (gal) = 3.785 l cubic foot (ft ³) = 7.476 gal = 28.32 l
	cubic centimeter (cm ³) = 1 milliliter (ml)	cubic inch (in ³) = 16.39 cm ³
	cubic meter (m ³) = 10^3 l	cubic yard (yd ³) = 0.7645 m ³
Temperature ^a	degrees Celsius (°C)	degrees Fahrenheit (°F) = 9/5 (°C) + 32
Mass ^b	kilogram (kg)	pound (lb) = 0.4536 kg
	gram (g) = 10^{-3} kg	ounce (oz) = 1/16 lb = 28.35 g
	metric tonne or metric ton (t) = 10^3 kg	short ton (commonly called "ton") = 2000 lb = 0.9071 t long ton = 2240 lb = 1.016 t
	quintal (q) = 10^2 kg	hundredweight (cwt) = 100 lb = 0.4536 q
Force/weight ^b	newton (N)	pound (lb) = 4.448 N
Pressure	pascal (Pa) = 1 N/m ²	
	kilopascal (kPa) = 10^3 Pa	pounds per square inch (psi) = 6.893 Pa
	torricelli (torr) = 1 mm of mercury (mm Hg) = 0.1333 kPa	inches of mercury (in Hg) = 25.4 mm Hg = 0.491 psi
	1 bar = 10^5 kPa	atmosphere (atm) = 1.013 bar
Energy ^c	joule (J)	foot-pound (ft-lb) = 1.356 J
	calorie (cal) = 4.187 J	
	kilocalorie (kcal or Cal) = 10^3 cal	British thermal unit (Btu) = 1055 J = 0.252 kcal
Power	watt (W) = joules per second (J/s)	
	kilowatt (kW) = 10^3 W	horsepower (hp) = 0.7457 kW