

# Construction Planning of a Block of Flats

Jesse Kytömäki

Bachelor's final project  
June 2017  
Construction engineering  
Facility management and renovation





## **ABSTRACT**

Odisee University College / Tampere University of Applied Sciences  
Construction engineering  
Facility engineering and renovation

**KYTÖMÄKI JESSE**  
Construction Planning of a Block of Flats

Tutor: Annemieke Goossens  
Co-tutor: David Peters

Bachelor final project  
Pages 31  
Appendices 20 pages  
June 2017

---

## CONTENTS

1	INTRODUCTION .....	6
2	THE BUILDING SITE .....	7
2.1	Information of the building site .....	7
2.2	Presentation.....	7
2.3	Underground parking garage .....	10
3	ORGANISATION OF THE BUILDING SITE .....	11
3.1	Site plan .....	11
3.1.1	Situation of the area .....	11
4	DRAWINGS .....	15
4.1	Section Drawing .....	15
4.2	Details .....	15
5	DETAILED STUDY .....	16
5.1	Balcony Elements .....	16
5.2	Equipment.....	17
5.2.1	Floor .....	17
5.2.2	Balcony .....	17
5.2.3	Façade and thermal Insulation .....	17
5.3	Step By Step Instructions.....	17
5.3.1	Formwork and supports .....	17
5.3.2	Installing the balcony and the reinforcing bars .....	18
5.3.3	Step 3. Situ concrete of the floor.....	19
5.3.4	Masonry walls .....	20
5.3.5	Roofing of the balcony.....	20
5.3.6	Blue stone.....	21
5.3.7	Thermal insulation and the façade .....	21
5.3.8	Doors and windows.....	21
5.3.9	Floor decking planks for the balcony.....	22
5.3.10	Situ concrete and acoustic insulation .....	22
5.3.11	Finishing works of the floor.....	22
6	COMPARATIVE STUDY .....	23
6.1	Belgian Building Technique .....	23
6.2	Finnish Building Technique.....	24
7	WORK SAFETY .....	26
7.1	Personal protective equipment.....	26
7.2	Preventing accidents on a building site.....	26
8	CONCLUSION .....	28

SOURCES.....	29
APPENDICES .....	30
Appendix 1. Site plan .....	30
Appendix 2. Section drawings.....	30
Appendix 4. Detailed study .....	30
Appendix 5. Comparative study .....	30
Appendix 6. Floor plan.....	31
Appendix 7. Schedule.....	31

**TERMS**

Situ concrete	Cast-in-place concrete
Isotec	Isotec insulated balcony connector
Site	Synonym for building site
Concrete mixer truck	Synonym for concrete mixing transport truck
Prefabricated element	Prefabricated concrete element

## 1 INTRODUCTION

This final project has been prepared while in exchange at Odisee University College in Aalst, Belgium. The purpose of this bachelor's final project was to plan parts of an apartment building located in the centre of Aalst. I was responsible of drawing a site plan, a section drawing and details for the building. In my final project I will do a technical study of one part of the building and discuss the differences of Belgian and Finnish building techniques. The focus of this final projects is on the drawings but I will also discuss the work safety on the building site.

The building site will have four new buildings and one existing building that will be renovated. The drawings of this project are specifically about one of the new buildings on the building site.

I want to thank the building manager Joni Audenaerdt from Cordeel. Also a thank you for my tutors Annemieke Goossens and David Peters from Odisee for helping me with this project.

## 2 THE BUILDING SITE

### 2.1 Information of the building site

Address: Louis D’Haeseleerstraat 19, 9300 Aalst

Constructor: Cordeel

General contractor: Cordeel

Architect: ABSCIS Architechen

### 2.2 Presentation

The building site is managed by the company Cordeel.

Cordeel is an international construction company which operates in Belgium, Netherlands, France, Germany, Serbia and Bulgaria.

The building site is located in the centre of Aalst. The building site will have total of four new buildings and there is one building under renovation. The building that is under renovation is a chapel. The building site does not have a lot of space so one of the new buildings is built in between two existing buildings. This building method is commonly used in Belgium since the lots here are usually small. Two of the buildings are next to the road called Louis D’Haeseleerstraat. The other three new buildings are in the inner yard. The building site will have an underground parking garage and a bicycle garage as well.



PICTURE 1. Chapel

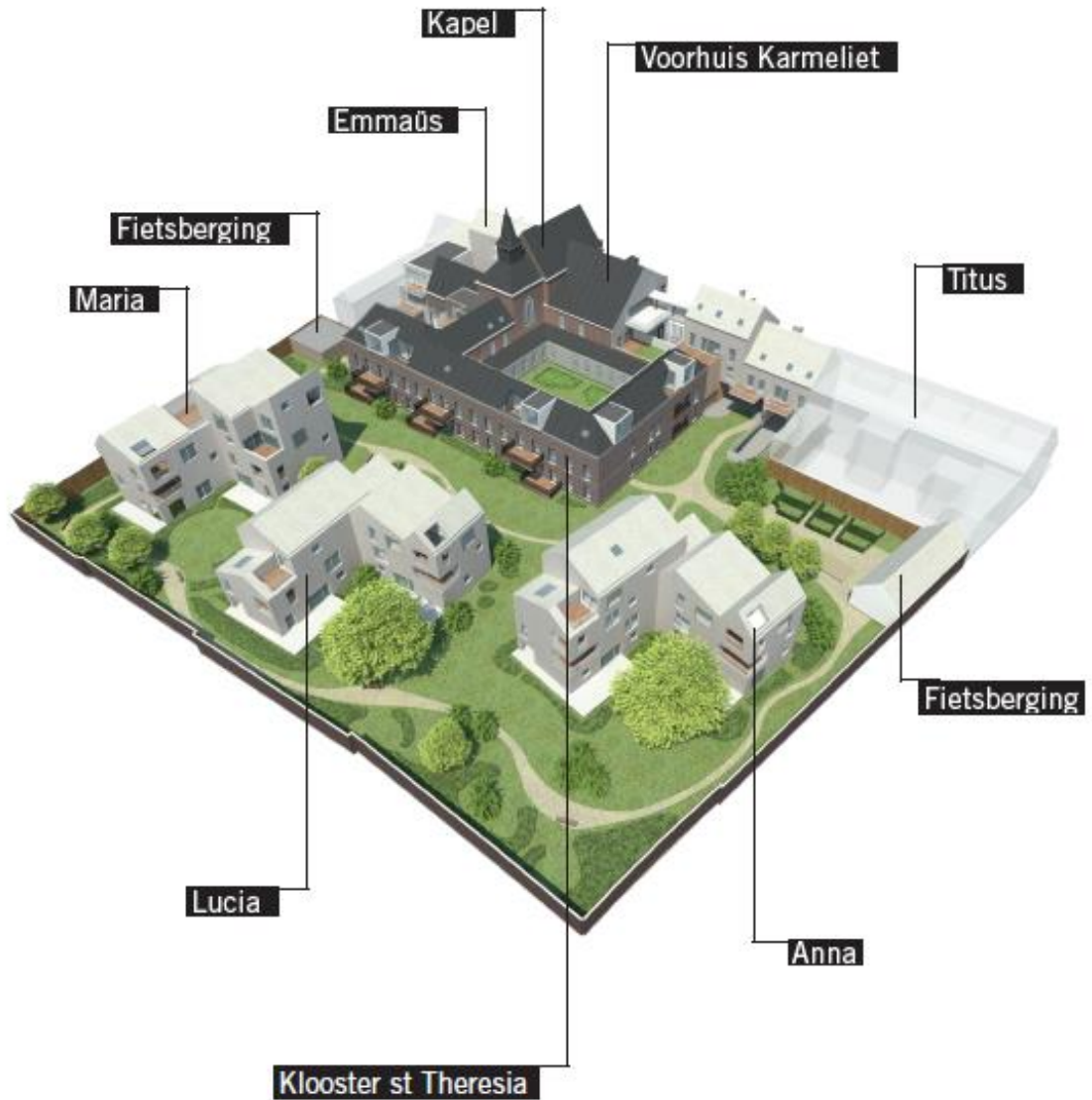

PICTURE 2. A 3D-model of the finished building site

This final project is focused mostly on the building called Anna which you can see on the PICTURE 2.

The building is a block of flats with 3 floors which will have 240m<sup>2</sup> of space per floor. The apartments are available for sale.



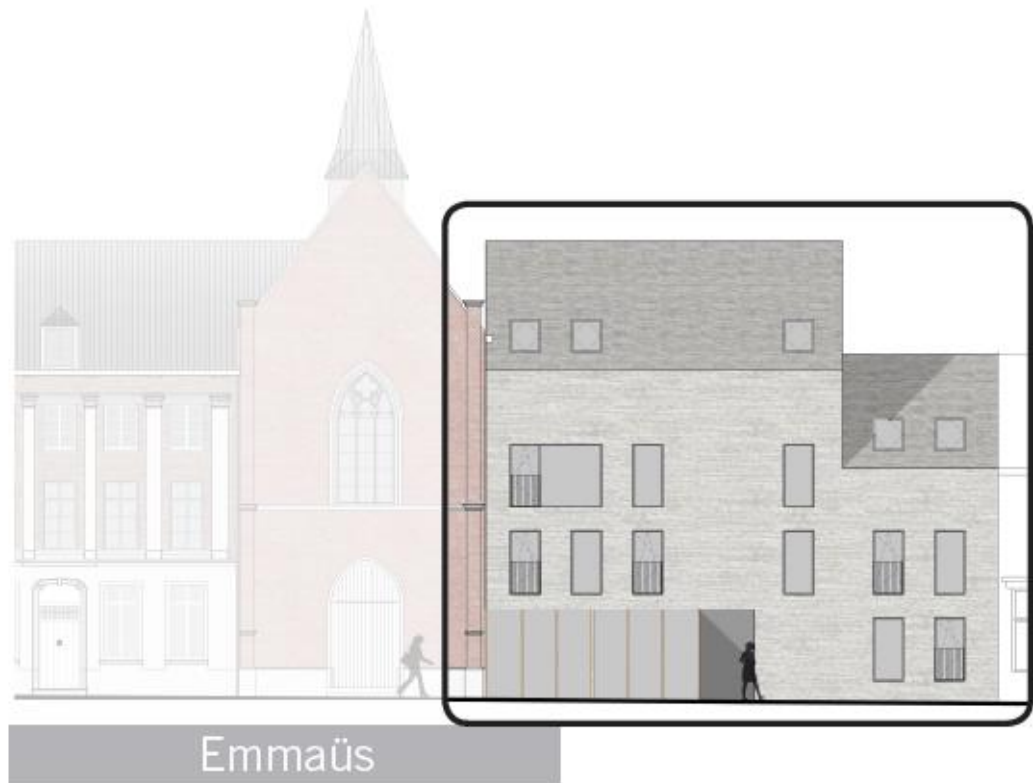

PICTURE 3. Building Emmaüs

Emmaüs is a building that is built between two already existing buildings. The building on the left is a chapel and on the right is a normal apartment building. The location next to the street makes this building more visible than the others.



PICTURE 4. A 3D-model of the building Lucia



### **3 ORGANISATION OF THE BUILDING SITE**

#### **3.1 Site plan**

Every building site should have a site plan to show how it is organised. The site plan shows the property lines, the site hut, changing rooms, tower cranes, driveways, parking, waste disposal, electrical center, ground water extraction, fire extinguishers, first aid, storage area, and storage containers. Having a detailed site plan is important because many of the other plans for the building site are based on it. Having a comprehensive site plan is linked with the building sites work safety and finances.

Two different site plans should be made. One which shows the existing conditions of the building site and one which shows the proposed conditions of the building site when the constructions are done.

##### **3.1.1 Situation of the area**

Right now in June 2017 the building site is very open and the constructions for the underground parking garage have been almost finished. The buildings Anna, Lucia and Maria are under construction. All these three buildings are block of flats that are constructed in the inner yard of the building site.

The site hut and the changing room for employees are right next to the street for easy access. The first floor is the site office and the second floor is the changing room for employees.

The tower crane is located in the small inner yard of the existing chapel.

The tower crane used in the building is Liebherr 200 EC-H and it has maximum radius of 60 meters and the lifting capacity at the maximum radius is 2,650kg. Liebherr 200 EC-H that it is not capable of lifting the 3,700kg prefabricated staircases for the buildings in the inner yard, which means that a mobile crane is necessary at the site and accordingly causes increase of expenses. I changed the tower crane to Liebherr 280 EC-H 12 Litronic to get rid of this problem. Liebherr 280 EC-H 12 Litronic is capable of lifting a maximum of 4,900kg at the radius of 60 meters which is more than enough for this building site.



PICTURE 6. Situation of the building Anna in May 2017.

The renovation of the pre-existing building has started. The original brick structure of the building is used again as it will be reinforced with concrete. There will be a new façade, roof and finishing works.



PICTURE 7. Renovation of the pre-existing building in June 2017.

When all the buildings in the inner yard are finished the second road to the building site will be closed which means that the buildings that are closer to the road are built last. The reason for that is that the concrete mixer trucks need to get to the inner yard when constructing the floors of the block of flats in there. As seen on the PICTURE 8 on the bottom right corner, the building Emmaüs will be constructed on top of the road that is shown on the site plan. The roads next to the building site are really narrow so getting to the building site with a concrete mixing transport trucks is not simple.

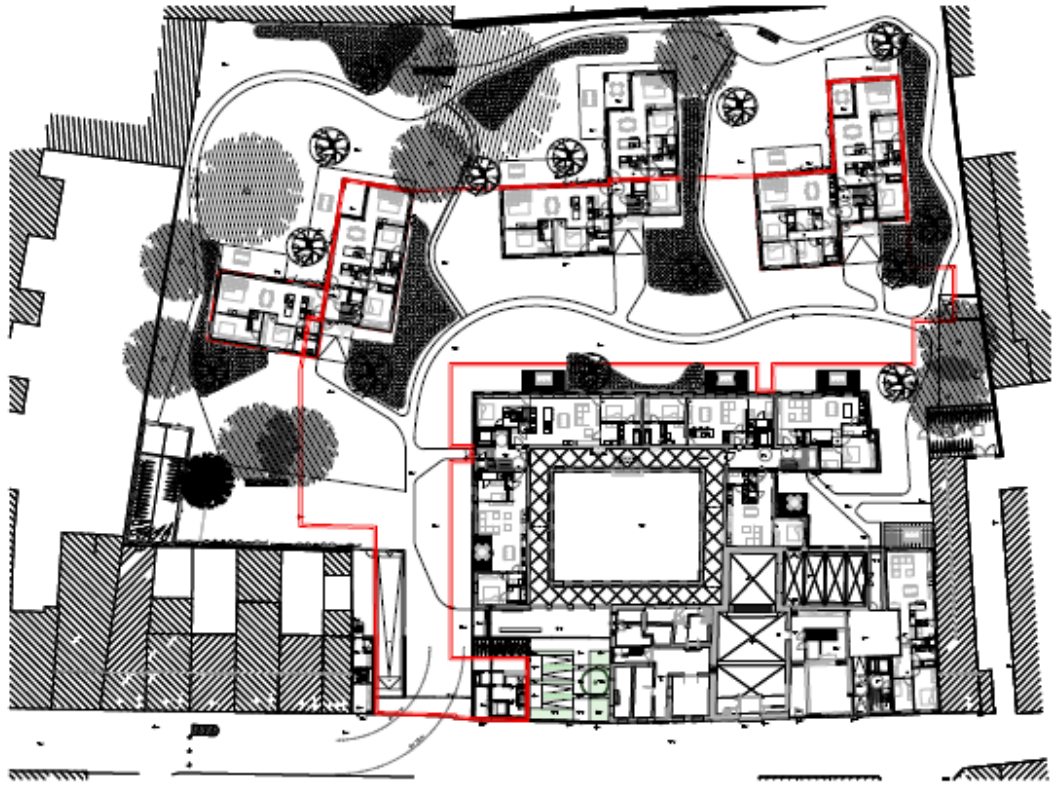

PICTURE 8. Site plan of the finished building site.

## **4 DRAWINGS**

The main purpose of this final project was to make the drawings for this building. In this section will be discussed what drawings were done for this final project. The drawings are shown as appendices at the end of this document.

### **4.1 Section Drawing**

For this final project a section drawing of the building Anna was drawn.

### **4.2 Details**

For this final project five details of the building Anna were drawn:

- Balcony detail
- Balcony – wall connection detail
- Floor - inside wall – floor connection detail
- Parking garage: green roof – wall connection detail
- Wall – roof – floor connection detail

For the detail of the parking garages green roof the cold bridges had to be taken into account. To prevent the cold bridges from happening a Marmox Thermoblocks were installed under the facade wall. Thermal blocks were also placed under the masonry wall to prevent another cold bridge from happening.

## 5 DETAILED STUDY

This is a detailed study for the detail of a balcony and a floor connecting with the wall. This study will show how this element was designed and why it was the preferred choice. The study will have a step by step breakdown of the detail and the equipment used.

### 5.1 Balcony Elements

The prefabricated balcony element used on this building has Isotec insulated balcony connector already installed on it at the factory. This makes the element relatively easy to install using a crane. Isotec insulated balcony connector is installed on top of the thermal insulation of the walls and it is used to prevent cold bridges caused by the balcony. The reinforcement bars of the balcony element will connect with the reinforcing bars of the floor. The reinforcing bars are welded together to get maximum support.

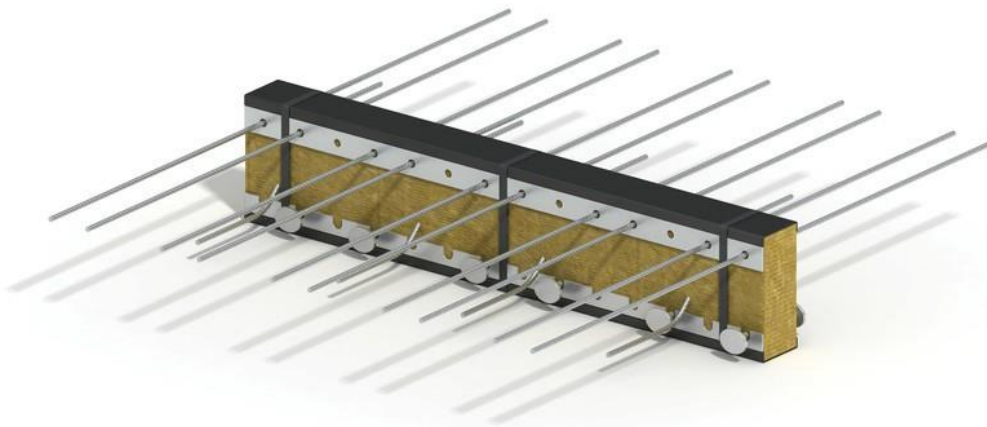

PICTURE 9. Insulated balcony connector (Ancon. Insulated balcony connectors.)



## **5.2 Equipment**

### **5.2.1 Floor**

Doka flex formwork system, props and tripods for supporting and formworks.

Reinforcement nets 8mm and 10mm

Reinforcing bars 8mm and 10mm

Concrete vibrator, trowels, bull float, hand float and a shovel for the finishing works of the concrete.

### **5.2.2 Balcony**

For the supporting of the balcony props, tripods and Doka H20 beams are needed.

EPDM membrane sheets, adhesive, primer, splice tape.

### **5.2.3 Façade and thermal Insulation**

To attach the façade an attachments from Plakabeton is used.

Hilti chemical screws to screw the attachment on its place.

For the masonry of the façade mortar, spirit level, trowels and measurement tape is needed.

## **5.3 Step By Step Instructions**

### **5.3.1 Formwork and supports**

The formwork for the floor is made by using Doka flex formwork system. A tripod is installed on the bottom of a prop and a supporting head on the top of a prop. The props should have a maximum spacing of 1m. Primary beams (3.90 m) and secondary beams (2.65 m) are used with a spacing of 30cm. This way the system can bear the load of concrete coming on top of it. The beams used are Doka H20. A ProFrame panel is put on top of the supports and it works as a formwork for the floor.



PICTURE 10. Doka flex formwork (Doka. Floor formwork.)

To support the prefabricated balcony for the installation props are used with a spacing of 0.5m.

### 5.3.2 Installing the balcony and the reinforcing bars

Concrete has great compressive strength but against huge amount of tension or pulling forces it will break. To give concrete tensile strength and make sure it won't break the reinforcement nets are installed on the bottom and top level of the concrete floor.

The reinforcing bars are installed on top of the formworks at the right level. The amount of steel used is mentioned on the drawings.

Tower crane is used to set up the balcony on its place.

### 5.3.3 Step 3. Situ concrete of the floor

First the concrete is poured into the formworks. When the concrete is poured it has plenty of air-bubbles that substantially weaken the concrete. To prevent this a concrete vibrator is used. Lastly the concrete has to be levelled.

The concrete has to dry for five days before building of the masonry walls can start.



PICTURE 11. Situ concrete of this detail



PICTURE 12. Pouring concrete

#### **5.3.4 Masonry walls**

After the situ concrete is masonry of the walls and continuing with the rough works of the next floor. Before the next step of this detail the structure of the building has to be finished.

#### **5.3.5 Roofing of the balcony**

EPDM-roofing will work as waterproofing for the balcony. The balcony is made with a slight angle so the rainwater will flow into the drainage.

The surface where the roofing will be placed must be cleaned so there will be nothing sharp that might damage the EPDM membrane.

Membrane should be laid out allowing it to hang out over the edges of the balcony. Next step is to add water based adhesive under the membrane and the membrane is folded in half. Once the membrane is laid on top of the adhesive it can be broomed into position to remove the air gaps. Now the other half of the membrane can be installed. Once the membrane is installed completely, the edges of the membrane are ready to be installed to the walls of the balcony.

If more than one sheet of roofing is required, it is possible to join two sheets together by using a tape and EPDM primer. First the EPDM primer is applied to the bottom sheet for 10mm from the edge. On top of the primer a splice tape is applied. Now the membrane can be installed on top of the tape.

### **5.3.6 Blue stone**

Blue stone is installed 50mm over the edge of the façade. The installation is made by spreading out mortar under the blue stone.

### **5.3.7 Thermal insulation and the façade**

The thermal insulation is installed against the masonry wall. The façade bricks are installed next to the thermal insulation but with a 30mm air gap between them. The air gap is used to ventilate the structure and to prevent water damages. When masonry the façade every third vertical joint must be left open allowing air flow into the air gap.

Under the balcony, a ventilation pipe and elastic mortar has to be installed on top of the façade and thermal insulation.

### **5.3.8 Doors and windows**

Windows and doors are installed by a subcontractor.

### **5.3.9 Floor decking planks for the balcony**

The plastic spacers are laid on the balcony with a spacing of 40cm. The battens are cut to the right size and installed on top of the spacers. The last step is to cut and install the planks using screws or a nail gun. There should be left a 3cm of empty space on the edges of the planks so the water can get easily under the planks into the drainage.

### **5.3.10 Situ concrete and acoustic insulation**

Next step is to pour 75mm layer of situ concrete. The process of situ concrete is discussed earlier in step 3.

After the concrete has dried for five days, two layers of acoustic insulation is installed on top of the concrete layer.

After installing the acoustic insulation another layer of concrete is poured on top of it. The thickness of this layer is 50mm.

### **5.3.11 Finishing works of the floor**

As it says in the room specification.

## 6 COMPARATIVE STUDY

### 6.1 Belgian Building Technique

Most of the buildings located in Belgium are made with concrete blocks or brick walls and this is also the case on this building site. This building technique is economical as the raw material is easily attainable and it is reusable. Structures made of concrete blocks are weatherproof, waterproof, airtight, tough and have great humidity resistance and fire safety.

Concrete blocks and bricks have great durability and require low maintenance cost. Compared to using prefabricated elements, when using block and brick wall structures the planning of the building can be more flexible. They are easily handleable materials which means that they are easily moved and used in a building site. The disadvantage of using concrete blocks or brick walls is that the actual construction of the building is time consuming.

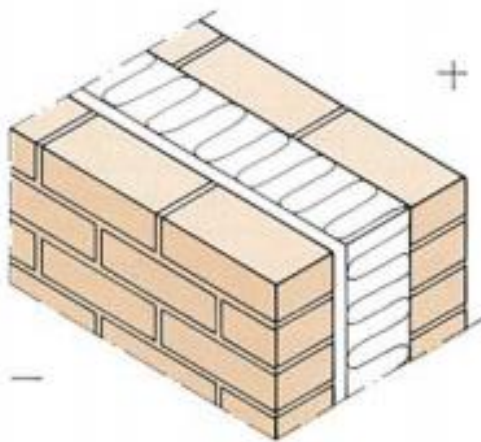

PICTURE 13. Example of a brick wall used in Belgium

## 6.2 Finnish Building Technique

Using situ concrete used to be popular in Finland until 1970's. In the 1970's prefabricated elements had a breakthrough in Finland and since then it has been the preferred choice. Situ concrete is still used on smaller projects. Especially on larger projects it is often not cost effective to use traditional cast-in-situ structures as opposed to precast and modular systems.

Estimate of 74% of block of flats and office buildings in Finland are made by using prefabricated concrete elements. This building technique is used because it makes building faster and more efficient. By using prestressed prefabricated concrete elements it is possible to use structures with long spans. These sandwich element building solutions are standardised and have been optimised in the earlier building projects. The planning of the building has to be very precise and the elements have to be delivered to the building site at the right time.

In Finland concrete blocks are frequently used for the foundations of detached houses and occasionally on low rise block of flats with two or three floors. On block of flats built with prefabricated elements blocks are commonly used as dividing walls inside an apartment.

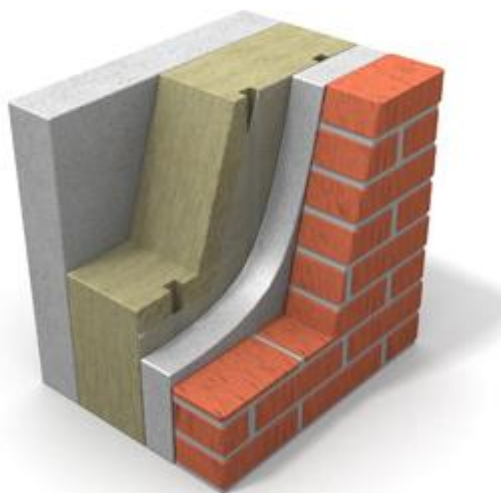

PICTURE 14. Example of a sandwich building element.



Traditional way of building in Finland and in the other Nordic countries is by using wooden structures. The forest industry of Finland accounts for approximately 20% of Finland's export revenue. The sector employs 150000 Finns directly and indirectly. Most of the wood produced is used in the construction sector. Approximately 90% of detached houses and almost 100% of leisure homes are made with wood. But this is only the case for smaller buildings, block of flats and office buildings are almost always built using concrete structures. The building technique of using timber (CLT) to build block of flats is rising steadily since wood is very ecological material to use.

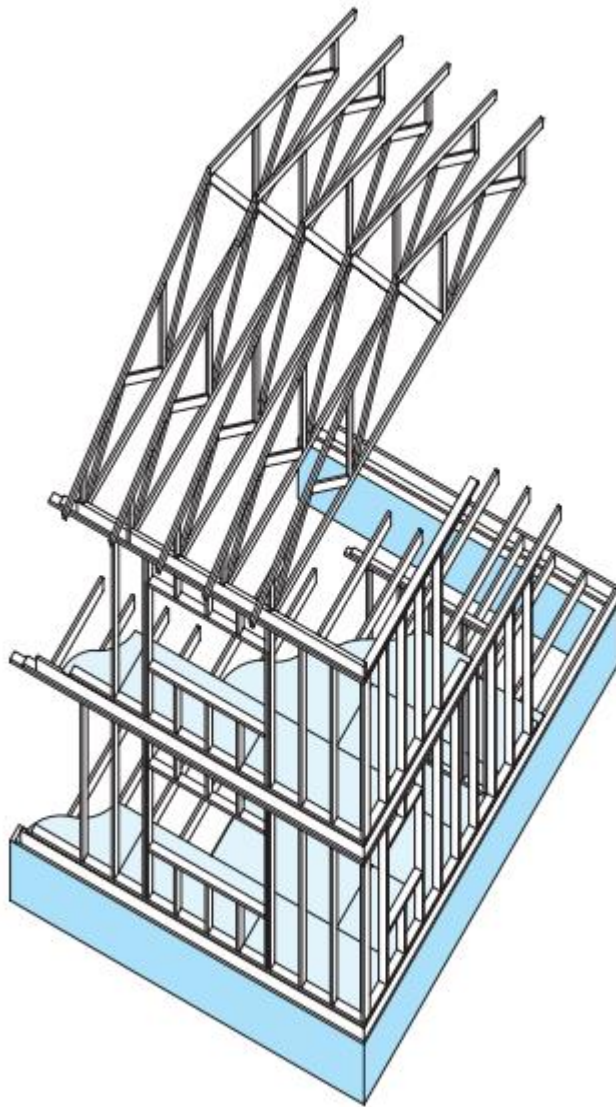

PICTURE 15. Typical structure of a Finnish detached house. (RT. Wooden structures.)

## **7 WORK SAFETY**

### **7.1 Personal protective equipment**

For safety reasons personal protective equipment has to be on while working on a building site. Personal protective equipment should contain:

- workwear
- high visibility safety vest
- safety shoes
- hardhat
- earmuffs
- cut resistant gloves
- kneepads
- safety glasses

### **7.2 Preventing accidents on a building site**

Typical accidents happening on a building site are slipping, tripping and falling. To prevent these accidents from happening the building site should be clean and well lit. The different kind of wastes should be sorted out in their own waste containers. Building site should have a storage area to store the building materials. Having disorganised and messy building site increases the risk of accidents.

Repetitive strain injuries are common while using blocks as a building material. While working with blocks the carpenter should try to keep his back straight while lifting heavy blocks. When moving blocks or bricks a brick cart should be used.

Falling is the top cause of construction fatalities. To prevent falling accidents from happening, having a plan for fall protection and providing the workers the right equipment is a must. When working two meters or more above lower levels a fall protection needs to be used. For example a guardrail systems, safety net systems, or personal fall arrest systems are all great solutions for fall protection. Every hole or opening that is wide enough for a leg to fall down must be covered with a board with a red cross marked on it. On larger openings a guardrail is required.

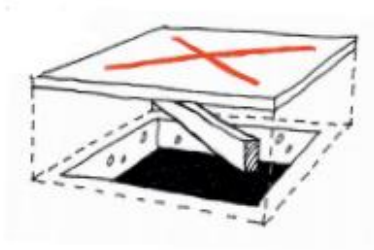

PICTURE 16. Marking of an opening on the floor (TTK. Safety in a building site)

In winter the risk of injuries increases since working in slippery and dark conditions is risky and might cause accidents. Especially a slippery or snowy scaffolding is very unsafe place to work on and should not be used. Roads on the building site need to be sanded to prevent slipping accidents.

Once a week the building site is inspected to check if there is any safety hazards. On these inspections scaffoldings, ladders, guardrail systems, electricity, lights, cleanness and dustiness are inspected. The usage of personal protective equipment is also inspected. Every worker is obligated to report or fix any safety shortcomings on the building site. Having weekly safety inspections and fixing the safety hazards is linked with good work safety and low accident rates.

The safety on this building site was decent but could have some upgrades. Some of the workers did not always use their personal safety equipment which increases the risk of an accident happening. Numerous things were not up to standard, for example safety glasses and high visibility workwear are not commonly used in Belgian building sites.

## 8 CONCLUSION

The greatest difference between Finnish and Belgian building techniques are enormous. In Belgium most of the buildings are made using bricks and blocks. As opposed to Finland where prefabricated elements are usually used when building a block of flats.

On this bachelor's final project I did the general drawings and details for a building site in Aalst. When I first came to the building site the construction of the buildings in the inner yard had begun. My tutor and I chose the details that I was going to make for the project. The building manager of the site helped me to understand the Belgian way of building. After showing him my drawings he seemed to be rather pleased with the results.

I chose to come to Belgium to do my final project because I wanted to challenge myself and learn more technical English so it could be possible for me to work abroad in the future. While conducting the project I learned more technical vocabulary in English than ever before. I also learned enormously about different building methods used in different countries. The greatest challenge of this final project was the differences between Finnish and Belgian building methods and finding information about the Belgian method. For example I learned about building with masonry and situ concrete, which aren't commonly used in Finland. Using MS Project for scheduling was challenging for me since I hadn't used it before this exchange. I had some language barriers since I'm not familiar with the Dutch language and most of the files I got were in Dutch. This was challenging at times and made it harder to search for information.

What surprised me was the difference in work safety. The safety of this building site was decent but not up to the standard I'm used to. It seems that Finland has more safety regulations than Belgium.

The project was very educational for me and it taught me the differences between Belgian and Finnish building process. The drawing assignments broadened my skill set substantially and by working on this project I acquired a lot of valuable experience that I can use for my advantage in the future.

## SOURCES

Ancon. Insulated balcony connectors. Read 22.5.2017.

<https://www.ancon.co.uk/products/insulated-balcony-connectors/isotec-concrete-to-concrete-connectors>

Doka. Floor formwork. Read 31.5.2017

<https://www.doka.com/en/system-groups/doka-floor-systems/timber-beam-floor-formwork/dokaflex/index>

Paroc. Sandwich building elements. Read 31.5.2017

<http://www.paroc.fi/ratkaisut-tuotteet/ratkaisut/rakennusten-eristaminen/uudisrakentaminen/ulkoseinat/kivirakenteiset-ulkoseinat#Betonisandwich-elementit/Tuuletuva%20rakenne>

Elementtisuunnittelu. Element planning. Read 31.5.2017

<http://www.elementtisuunnittelu.fi/fi/valmisosarakentaminen>

Betoni. Element construction. Read 2.6.2017

<http://betoni.com/betonirakentaminen/elementtirakentaminen/talonrakentaminen/>

Betoni. Block building manual. Read 2.6.2017

[http://betoni.com/wp-content/uploads/2015/04/harkkokasikirja\\_2016-sisallysluettelo.pdf](http://betoni.com/wp-content/uploads/2015/04/harkkokasikirja_2016-sisallysluettelo.pdf)

Ratu. Rakennustyömaan aluesuunnittelu C2-0299. Site organisation plan (February 2007)

TTK. Safety in a building site. Read 5.6.2017

[https://ttk.fi/files/4658/Turvallisesti\\_raksalla.pdf](https://ttk.fi/files/4658/Turvallisesti_raksalla.pdf)

Työsuojelu. Safety measures. Read 5.6.2017

<http://www.tyosuojelu.fi/tyosuojelu-tyopaikalla/tyoolosuohdemittarit/tr-mittari->

Metla. Building with wood. Read 11.6.2017

<http://www.metla.fi/metinfo/sustainability/c1-building-with-wood.htm>

Rakennustieto. Pientalon puurakenteet RT 82-10820 Wooden structures (April 2004)

## APPENDICES

### Appendix 1. Site plan

- Site plan, 1 (3)
- Site plan, 2 (3)
- Underground garage plan, 3 (3)

### Appendix 2. Section drawings

- Section drawing, 1 (3)
- Section drawing, 2 (3)
- Façade drawing, 3 (3)

### Appendix 3. Details

- Detail, 1 (5)
- Detail, 2 (5)
- Detail, 3 (5)
- Detail, 4 (5)
- Detail, 5 (5)

### Appendix 4. Detailed study

- Detailed study part 1 (6)
- Detailed study part 2 (6)
- Detailed study part 3 (6)
- Detailed study part 4 (6)
- Detailed study part 5 (6)
- Detailed study part 6 (6)

### Appendix 5. Comparative study

- Detail, 1 (2)
- Detail, 2 (2)

#### Appendix 6. Floor plan

- Ground floor 1 (5)
- Second floor, 2 (5)
- Third floor 3 (5)
- Fourth floor 4 (5)
- Roof, 5 (5)

#### Appendix 7. Schedule

- Schedule 1 (1)

#### Appendix 8. Technical documents

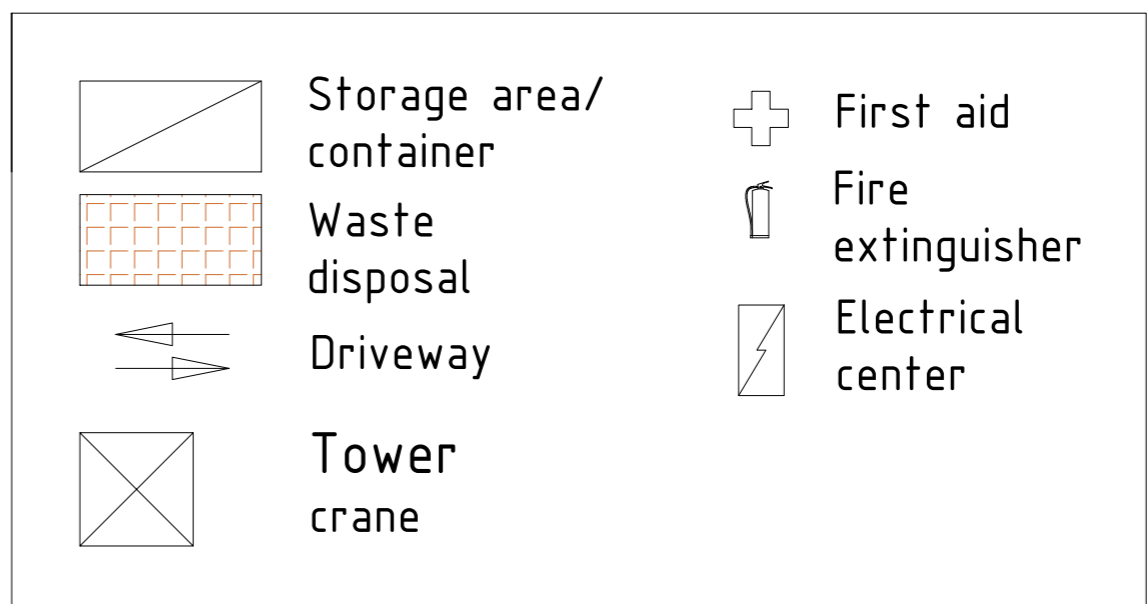
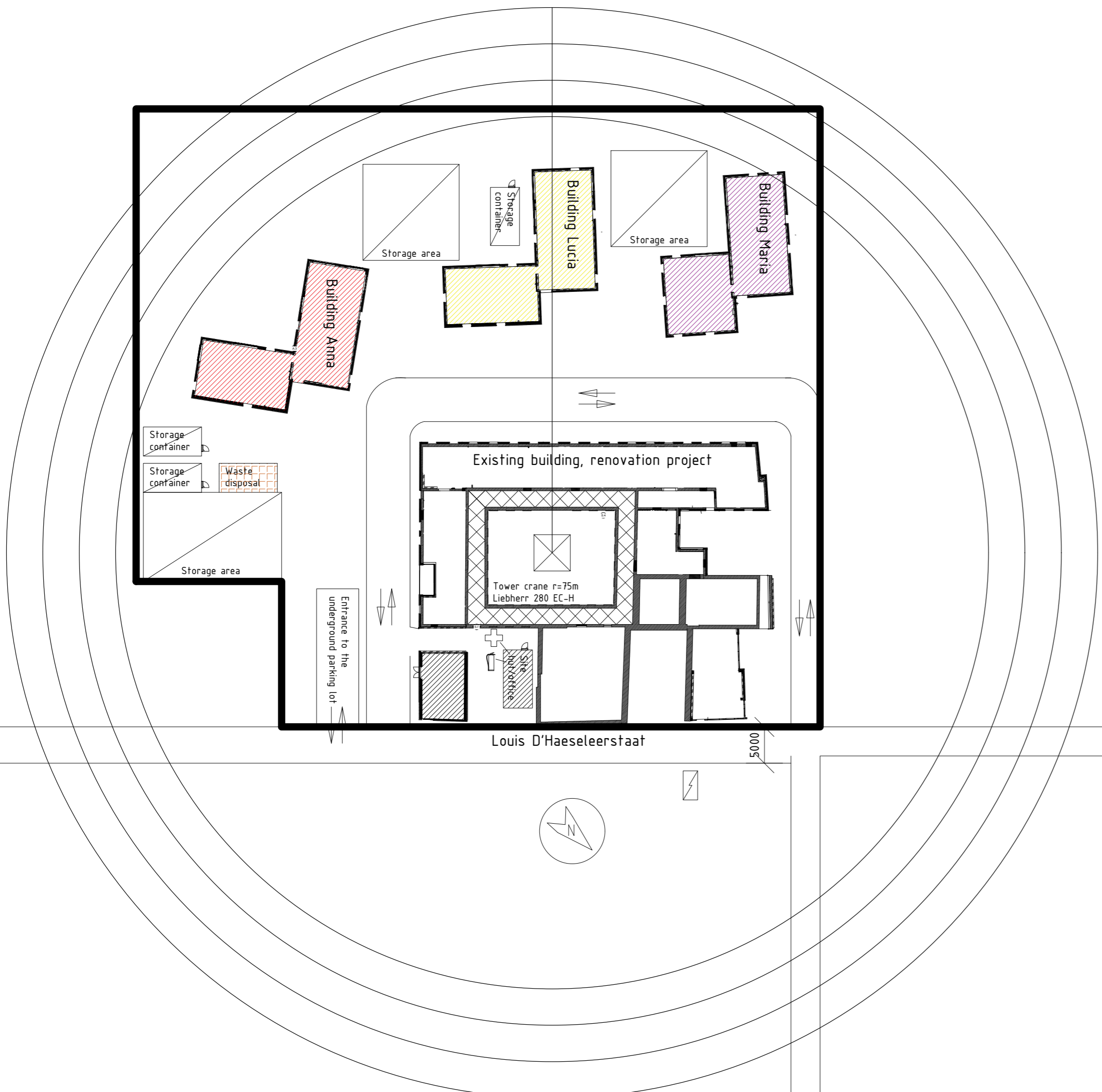

Liebherr 280 EC-H 12 Litronic  
 Maximum lifting capacity

75m	2,800kg
70m	3,600kg
65m	4,200kg
60m	4,900kg

Kaupunginosa	Korttelitila	Tonnti/mo	Viranomaisten merkintöitä
Aalst			
Rakennusoirenpeide	NEW CONSTRUCTION		Piirustuslaji Site plan
Rakennuskohde	BACHELOR'S FINAL PROJECT 2017		Piirustuksen sisältö Mittakaavat Site plan 1 : 500
		Allekirjoitus	Suunnitteluala, työnnumero ja piirustusnumero Muutos
Päiväys, suunnittelija, nimen selvitys ja koulutus			Yhteyshenkilö Tiedosto
07.06.17, Jesse Kytömäki, engineer			



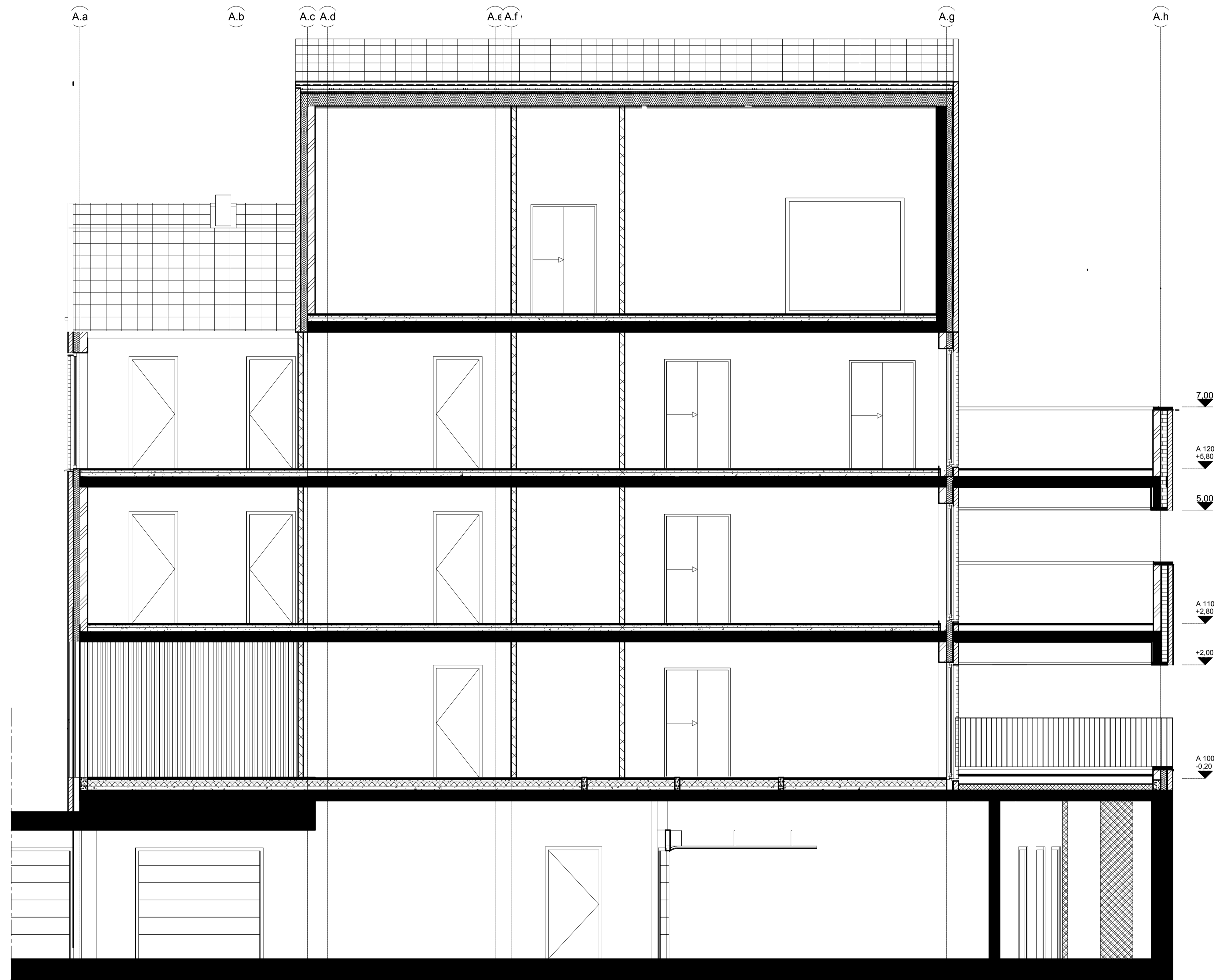

Kaupunginosa	Korttelinimi	Tontinno	Viranomaisten merkintöjä
Aalst	Louis D'Haeseleerstraat		
Rakennusompeide			Juoks.no
NEW CONSTRUCTION			
Rakennuskohde			Mittakaavat
			1 : 50
	Aluekirjoitus	Suunnitteluala, työnnumero ja piirustusnumero	Muutos
Päiväys, suunnittelija, nimen selvennys ja koulutus	Yhteyshenkilö		Tiedosto
01.03.2015, Jesse Kytömäki, engineer			

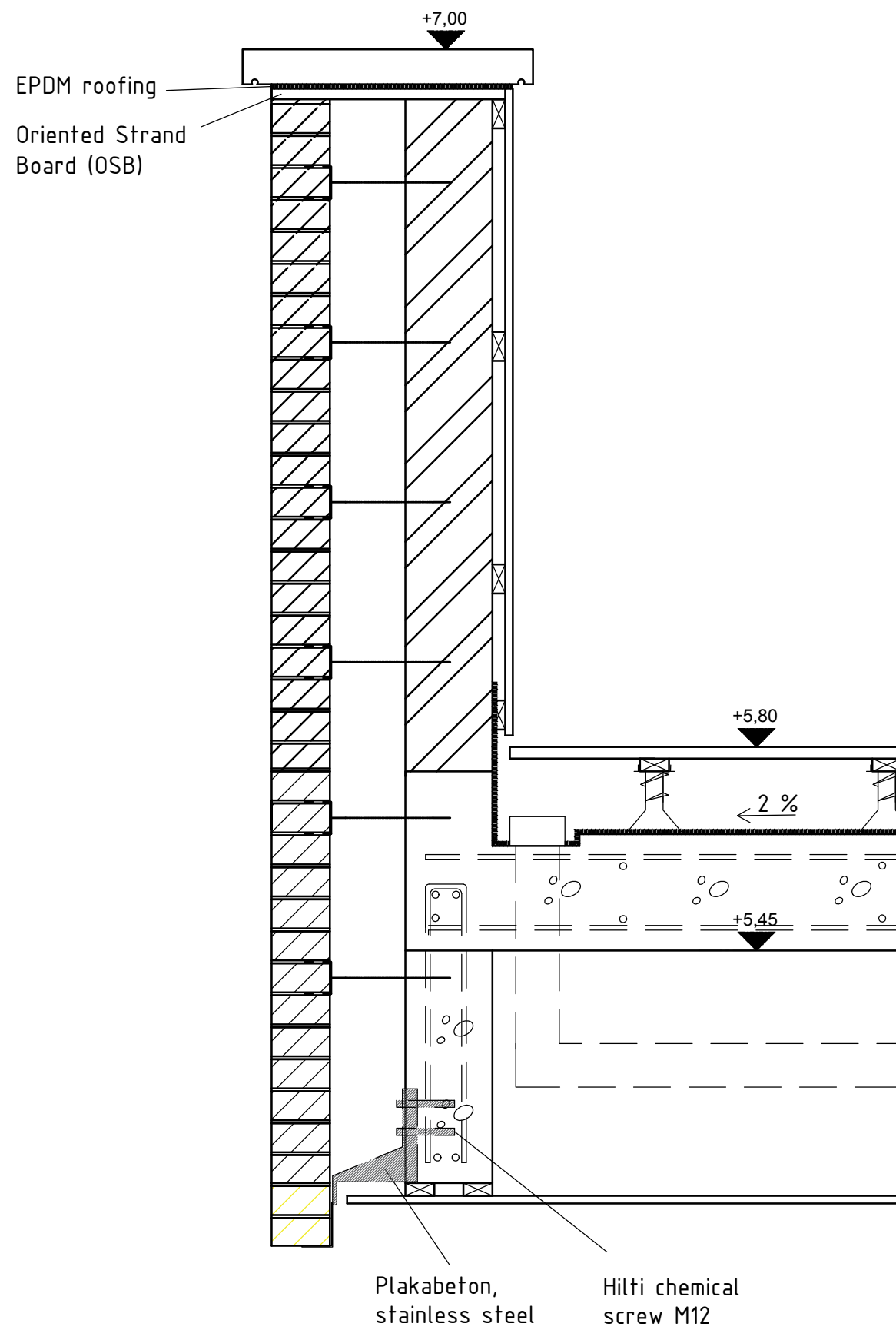

Kaupunginosa	Kortteli/tila	Tontti/rno	Viranomaisten merkintöjä
AALST			
Rakennusoimenpide			Piirustuslaji
NEW CONSTRUCTION			DETAIL
Rakennuskohde			Piirustuksen sisältö
BACHELOR'S FINAL PROJECT 2017			BALCONY DETAIL
			Mittakaavat
			1 : 10
		Allekirjoitus	Suunnitteluala, työnumero ja piirustusnumero
			Muutos
Päiväys, suunnittelija, nimen selvennys ja koulutus			Yhteyshenkilö
06.06.2017, Jesse Kytömäki, engineer			Tiedosto

# FLOOR

Floating floor treatment  
 Situ concrete 50mm type c20/25 S2  
 Acoustic sound proofing 2x5mm YELOfon HD5  
 Situ concrete 75mm type C20/25 S2  
 Situ concrete 200mm type C20/25 S2  
 Ceiling material

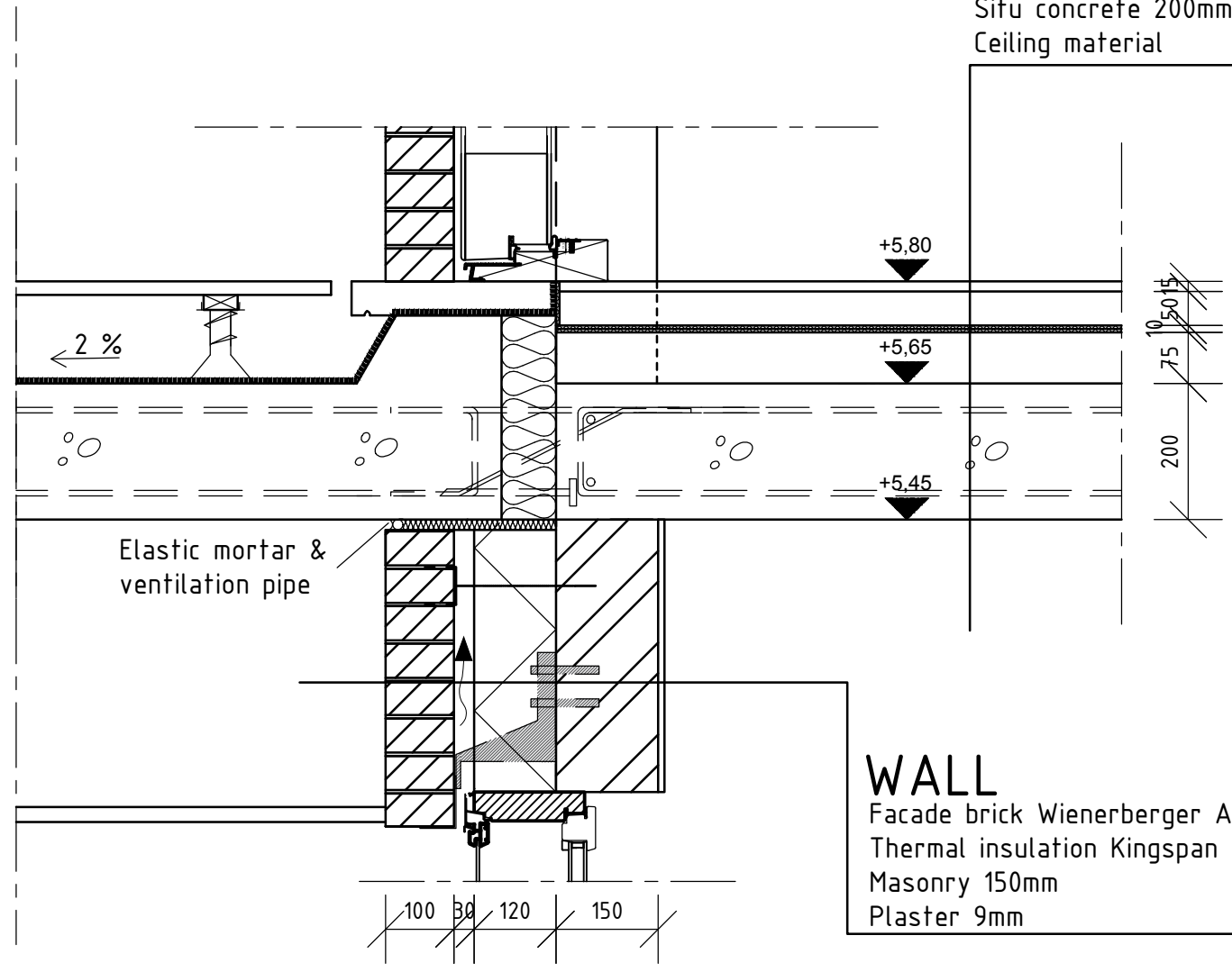

# WALL

Facade brick Wienerberger Agora wit ivoor 210x100x50mm  
 Thermal insulation Kingspan Therma TP10 120mm  
 Masonry 150mm  
 Plaster 9mm

Kaupunginosa	Kortteli/tila	Tontti/rno	Viranomaisten merkintöjä
AALST			
Rakennusoimenpide			Piirustuslaji
NEW CONSTRUCTION			Juoks.no
Rakennuskohde			DETAIL
BACHELOR'S FINAL PROJECT			Piirustuksen sisältö
2017			Mittakaavat
			BALCONY - WALL - FLOOR
			1 : 10
			CONNECTION
		Allekirjoitus	Suunnitteluala, työnumero ja piirustusnumero
			Muutos
Päiväys, suunnittelija, nimen selvennys ja koulutus			Yhteyshenkilö
06.06.2017, Jesse Kytömäki, engineer			Tiedosto

## FLOOR

Floating floor treatment  
 Situ concrete 50mm type c20/25 S2  
 Acoustic sound proofing 2x5mm YELOfon HD5  
 Situ concrete 75mm type C20/25 S2  
 Situ concrete 200mm type C20/25 S2  
 Ceiling material

## FLOOR 2

Floating floor treatment  
 Situ concrete 50mm type c20/25 S2  
 Acoustic sound proofing 2x5mm YELOfon HD5  
 Situ concrete 75mm type C20/25 S2  
 Situ concrete 130mm type C20/25 S2  
 Prefabricated slab 70mm  
 Ceiling material

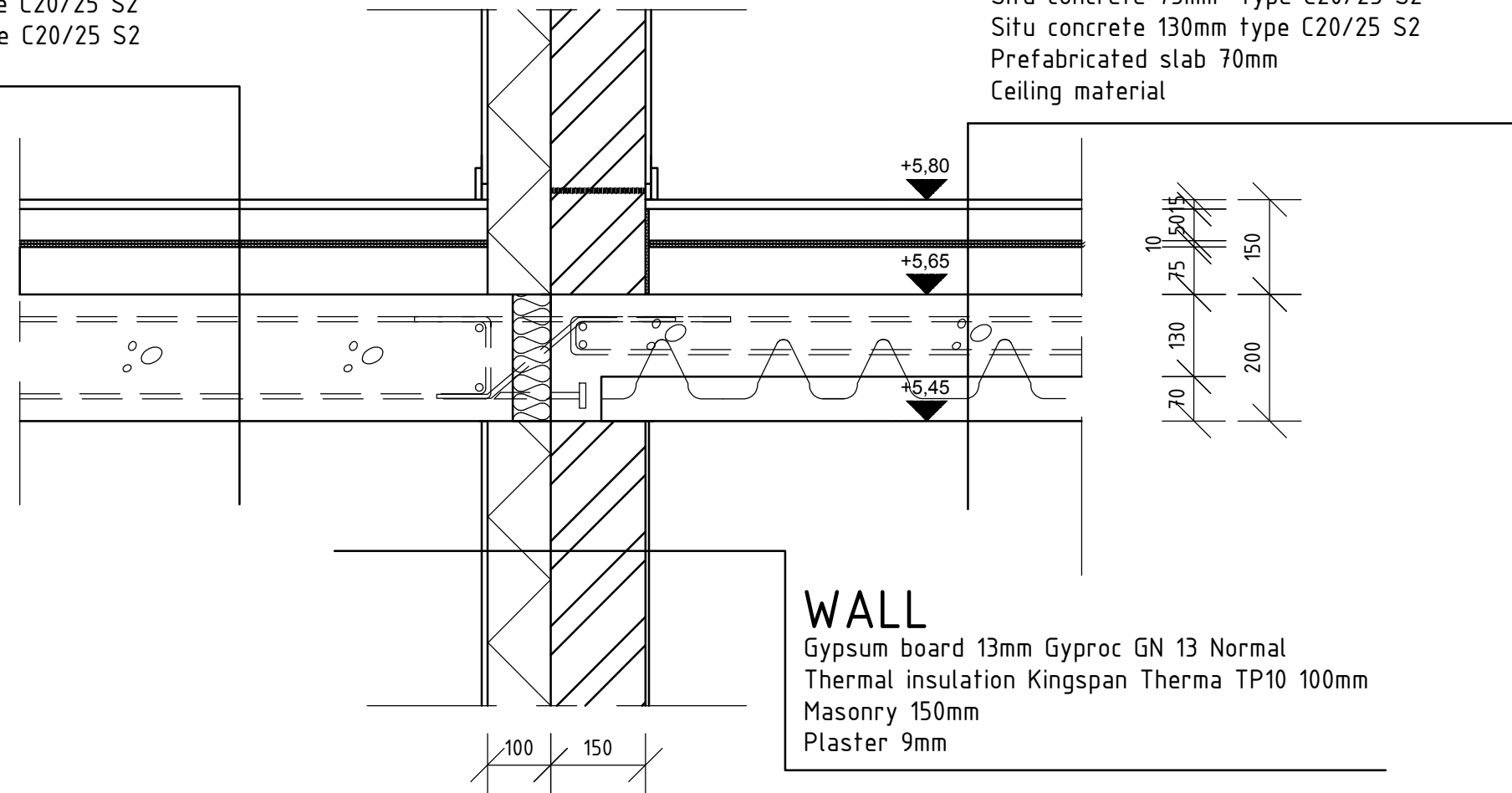

## WALL

Gypsum board 13mm Gyproc GN 13 Normal  
 Thermal insulation Kingspan Therma TP10 100mm  
 Masonry 150mm  
 Plaster 9mm

Kaupunginosa	Kortteli/tila	Tontti/rno	Viranomaisten merkintä
AALST			
Rakennusoimenpide			Piirustuslaji
NEW CONSTRUCTION			DETAIL
Rakennuskohde			Piirustuksen sisältö
BACHELOR'S FINAL PROJECT 2017			FLOOR - WALL - FLOOR CONNECTION
		Allekirjoitus	Mittakaavat
			1 : 10
			Muutos
			Tiedosto
Päiväys, suunnittelija, nimen selvennys ja koulutus			Yhteyshenkilö
06.06.2017, Jesse Kytömäki, engineer			

## FLOOR

Floating floor treatment  
 Situ concrete 50mm type c20/25 S2  
 Thermal insulation Kingspan Therma TP10 80mm  
 Situ concrete 75mm + 130mm type C20/25 S2  
 Prefabricated slab 70mm  
 Ceiling material

## WALL

Plaster 9mm  
 Masonry 150mm  
 Thermal insulation Kingspan Therma TP10 120mm  
 Air cavity 30mm  
 Facade brick Wienerberger Agora wit ivoor 210x100x50mm

## GREEN ROOF

Vegetation  
 Lawn substrate (soil)  
 Filter fabric (Optigreen filter fleece type 105)  
 Optigreen Drainage Board Type FKD 60 B0 (60 mm), filled with Drainage Layer Type Perl 8/16 (45 l/m<sup>3</sup>)  
 Filter fabric (Optigreen Protection and Storage Fleece Type RMS 500)  
 Waterproofing membrane EPDM 1.52mm  
 Thermal insulation Isover KL-37 100mm  
 Vapour barrier 0.2mm Timburg  
 Concrete 350mm type C30/37 S2

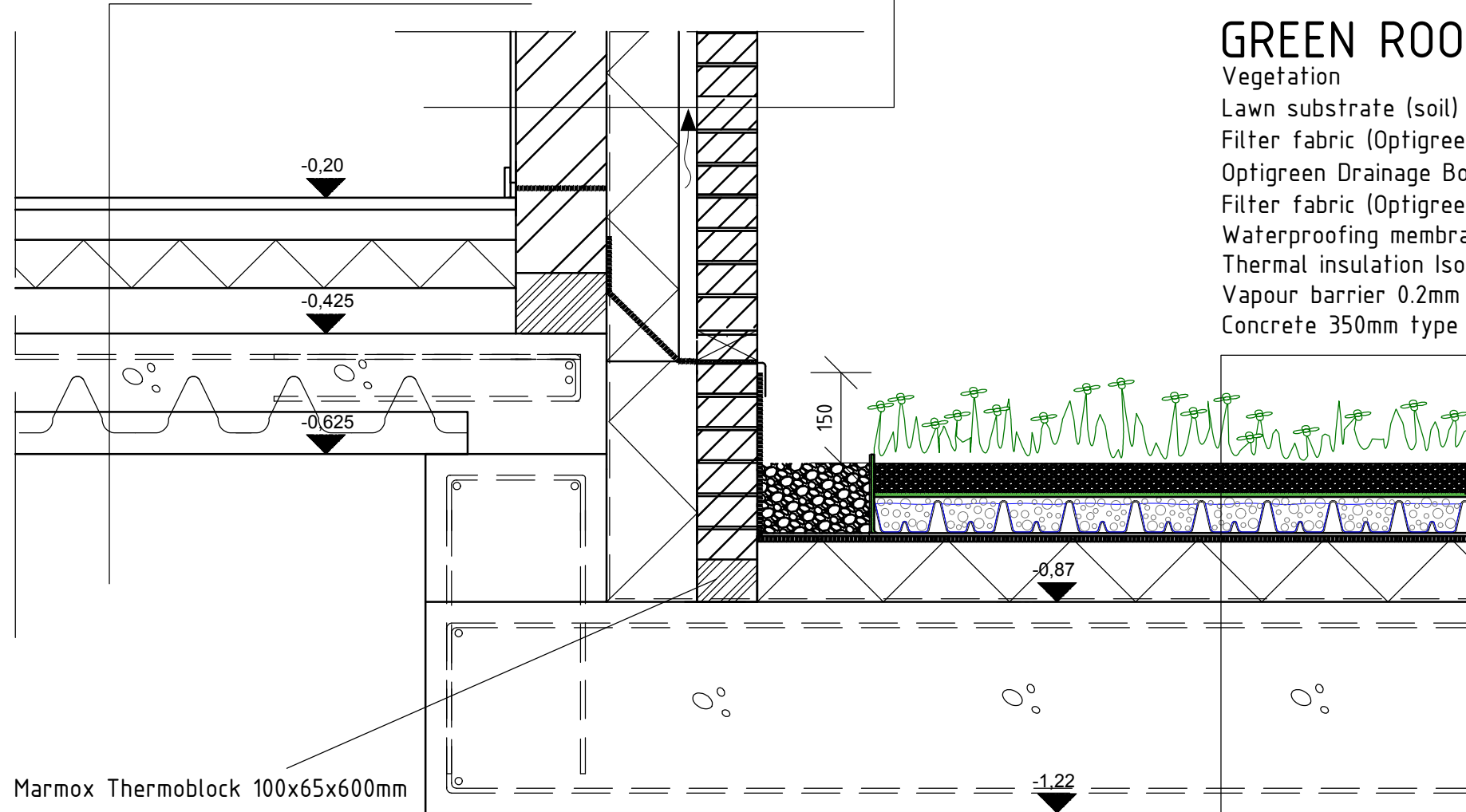

Marmox Thermoblock 100x65x600mm

Kaupunginosa	Kortteli/tila	Tontti/rno	Viranomaisten merkintöjä
AALST			
Rakennusoimenpide			Piirustuslaji
NEW CONSTRUCTION			Juoks.no
Rakennuskohde			Piirustuksen sisältö
BACHELOR'S FINAL PROJECT			Mittakaavat
2017			PARKING GARAGE 1 : 10
			WALL - GREEN ROOF CONNECTION
		Allekirjoitus	Suunnitteluala, työnnumero ja piirustusnumero
			Muutos
		Päiväys, suunnittelija, nimen selvitys ja koulutus	Yhteyshenkilö
		06.06.2017, Jesse Kytömäki, engineer	Tiedosto

# ROOF

Roof tiles WIENERBERG ACTUA 10  
 Tile battens 22x25mm  
 Counter battens 22x25mm  
 Underlayment, BIPLEX -roofing  
 Rafters 240mm k900  
 Thermal insulation Isover KL-33 200 mm  
 Battens 22x75  
 Gypsum board 13mm Gyproc GN 13 Normal

# FLOOR

Floating floor treatment  
 Situ concrete 50mm type c20/25 S2  
 Acoustic sound proofing 2x5mm YELOfon HD5  
 Situ concrete 75mm type C20/25 S2  
 Situ concrete 130mm type C20/25 S2  
 Prefabricated slab 70mm  
 Ceiling material

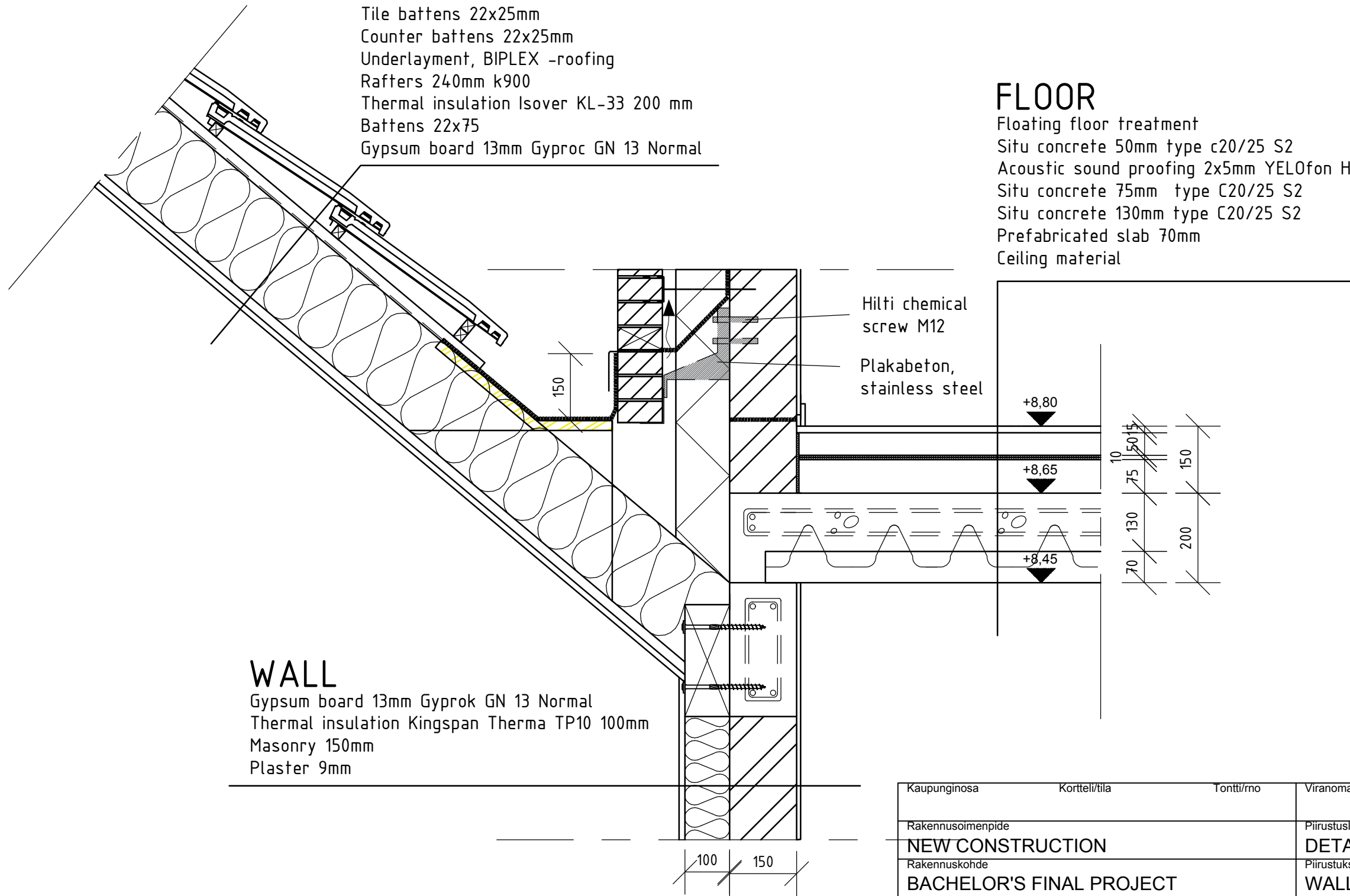

# WALL

Gypsum board 13mm Gyproc GN 13 Normal  
 Thermal insulation Kingspan Therma TP10 100mm  
 Masonry 150mm  
 Plaster 9mm

Kaupunginosa	Kortteli/tila	Tontti/mo	Viranomaisten merkintöjä
Rakennusoimenpide	NEW CONSTRUCTION		Piirustuslaji DETAIL
Rakennuskohde	BACHELOR'S FINAL PROJECT 2017		Piirustuksen sisältö WALL - ROOF CONNECTION WALL - FLOOR CONNECTION
		Allekirjoitus	Mittakaavat 1 : 10
			Suunnitteluala, työnnumero ja piirustusnumero
			Muutos
Päiväys, suunnittelija, nimen selvennys ja koulutus	06.06.2017, Jesse Kytömäki, engineer		Yhteyshenkilö
			Tiedosto

# 1 Formwork and supports

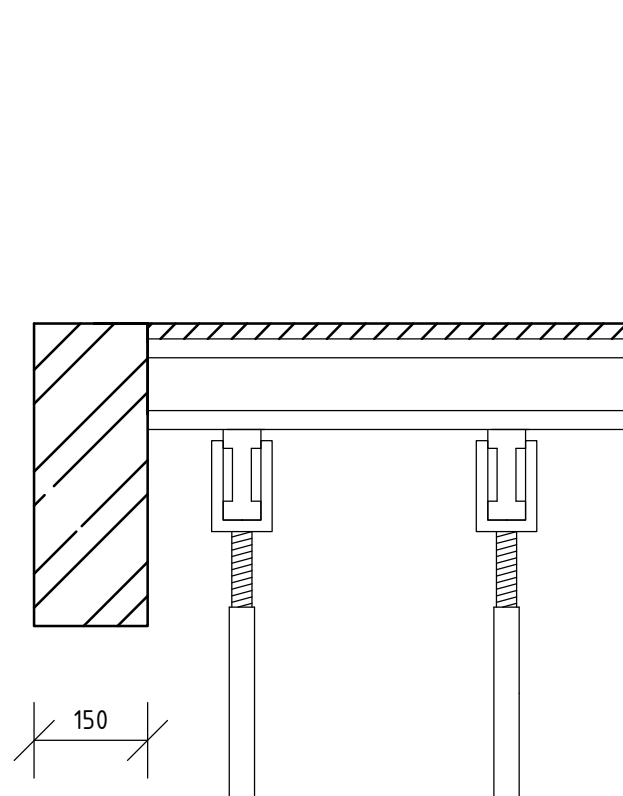

# 2 Prefabricated balcony and the reinforcement bars

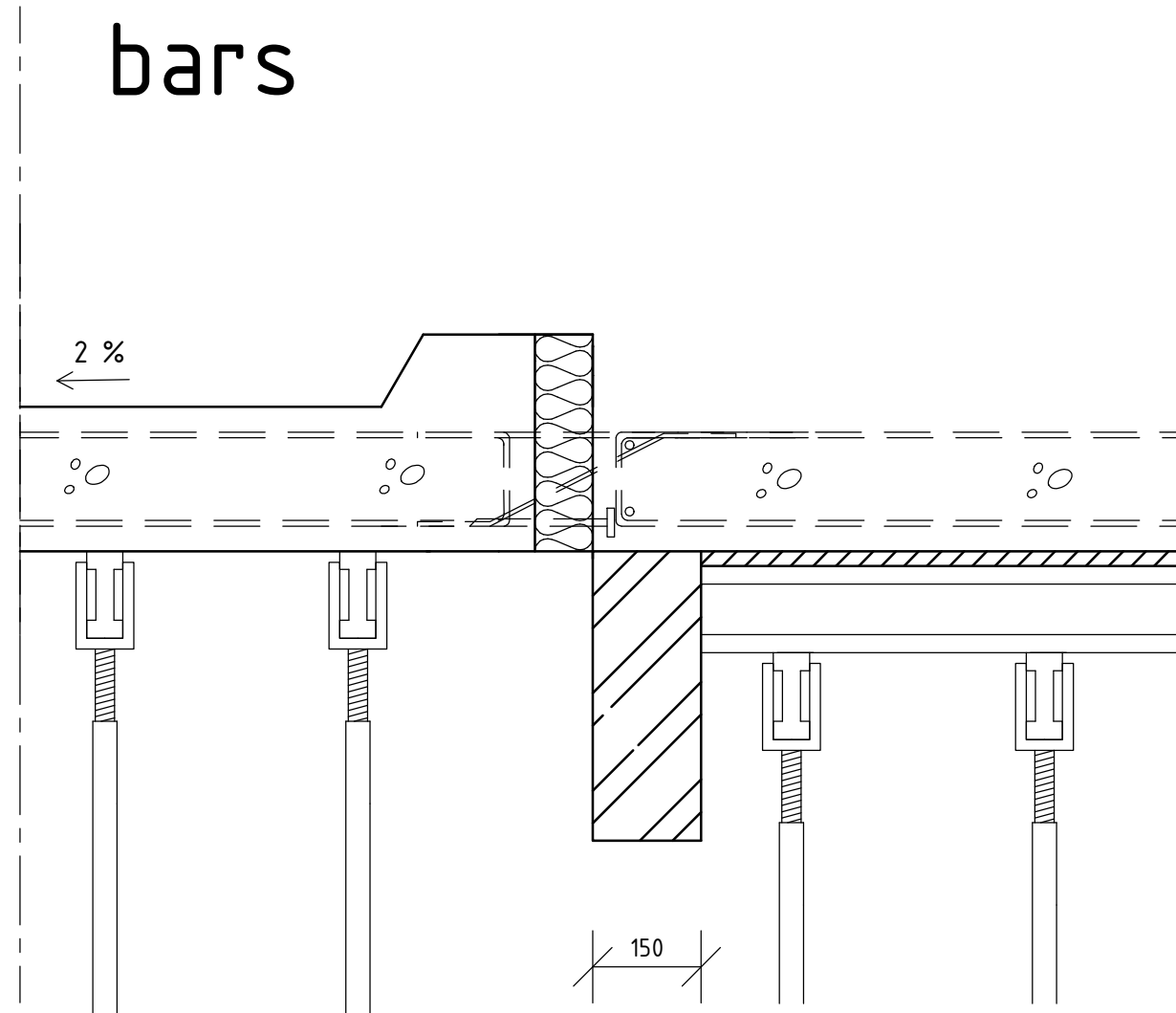

Kaupunginosa <b>AALST</b>	Kortteli/tila	Tonnti/rno	Viranomaisten merkintöjä
Rakennusoimenpide <b>NEW CONSTRUCTION</b>			Piirustuslaji <b>DETAILED STUDY PARTS 1-2</b>
Rakennuskohde <b>BACHELOR'S FINAL PROJECT 2017</b>			Piirustuksen sisältö <b>BALCONY - WALL - FLOOR CONNECTION</b>
		Allekirjoitus	Suunnitteluala, työnumero ja piirustusnumero
Päiväys, suunnittelija, nimen selvennys ja koulutus <b>06.06.2017, Jesse Kytömäki, engineer</b>			Muutos
			Yhteyshenkilö
			Tiedosto
			Juoks.no
			Mittakaavat <b>1 : 10</b>

# 3 Situ concrete

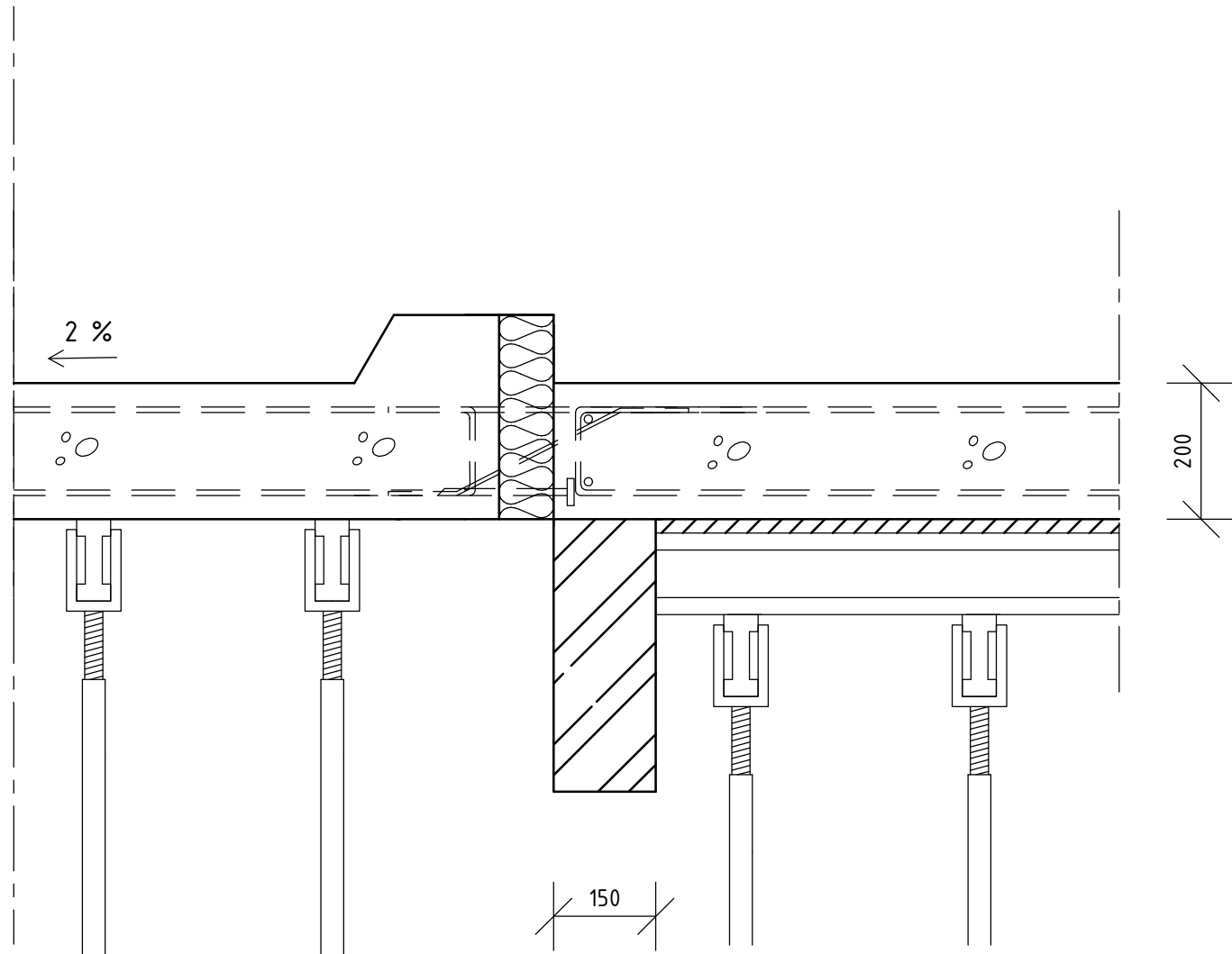

# 4 Walls and the next floor of the building

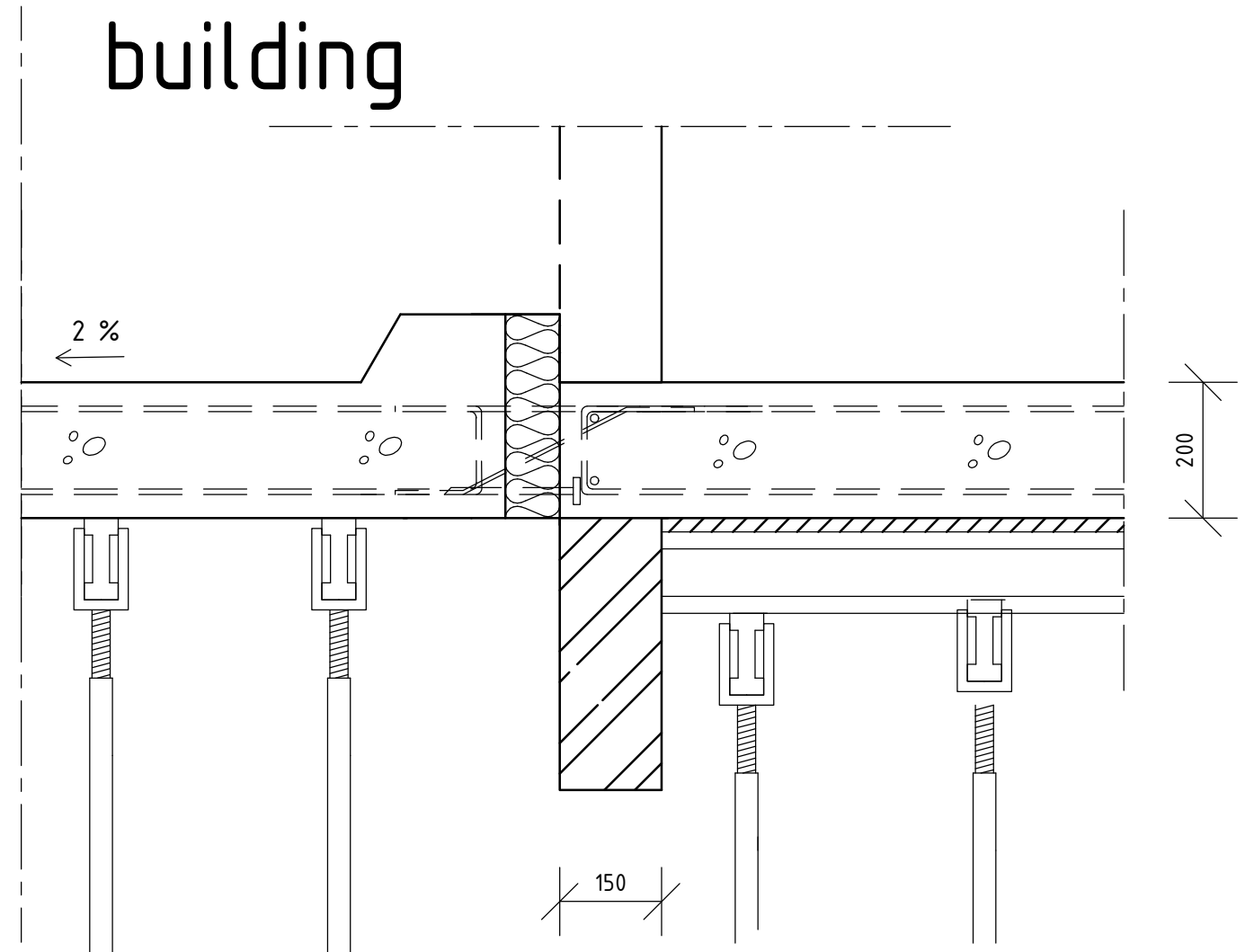

Kaupunginosa	Kortteli/tila	Tonnti/mno	Viranomaisten merkintöjä
AALST			
Rakennusoimenpide			Piirustuslaji
NEW CONSTRUCTION			DETAILED STUDY PARTS 3-4
Rakennuskohde			Piirustuksen sisältö
BACHELOR'S FINAL PROJECT 2017			BALCONY - WALL - FLOOR CONNECTION
		Allekirjoitus	Suunnitteluala, työnnumero ja piirustusnumero
			Muutos
Päiväys, suunnittelija, nimen selvennys ja koulutus			Yhteyshenkilö
06.06.2017, Jesse Kytömäki, engineer			Tiedosto



# 5 Roofing of the balcony

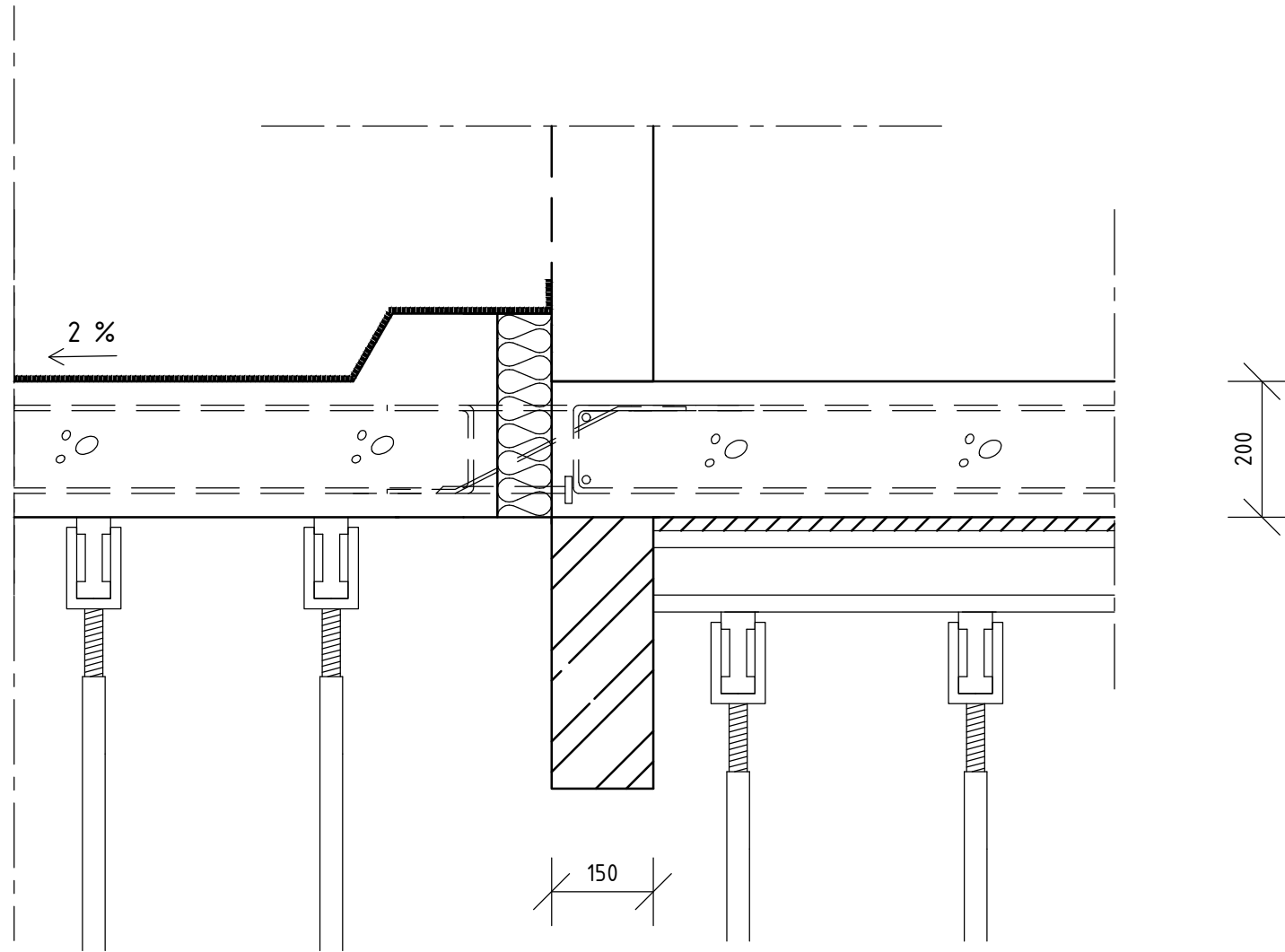

# 6 Blue stone

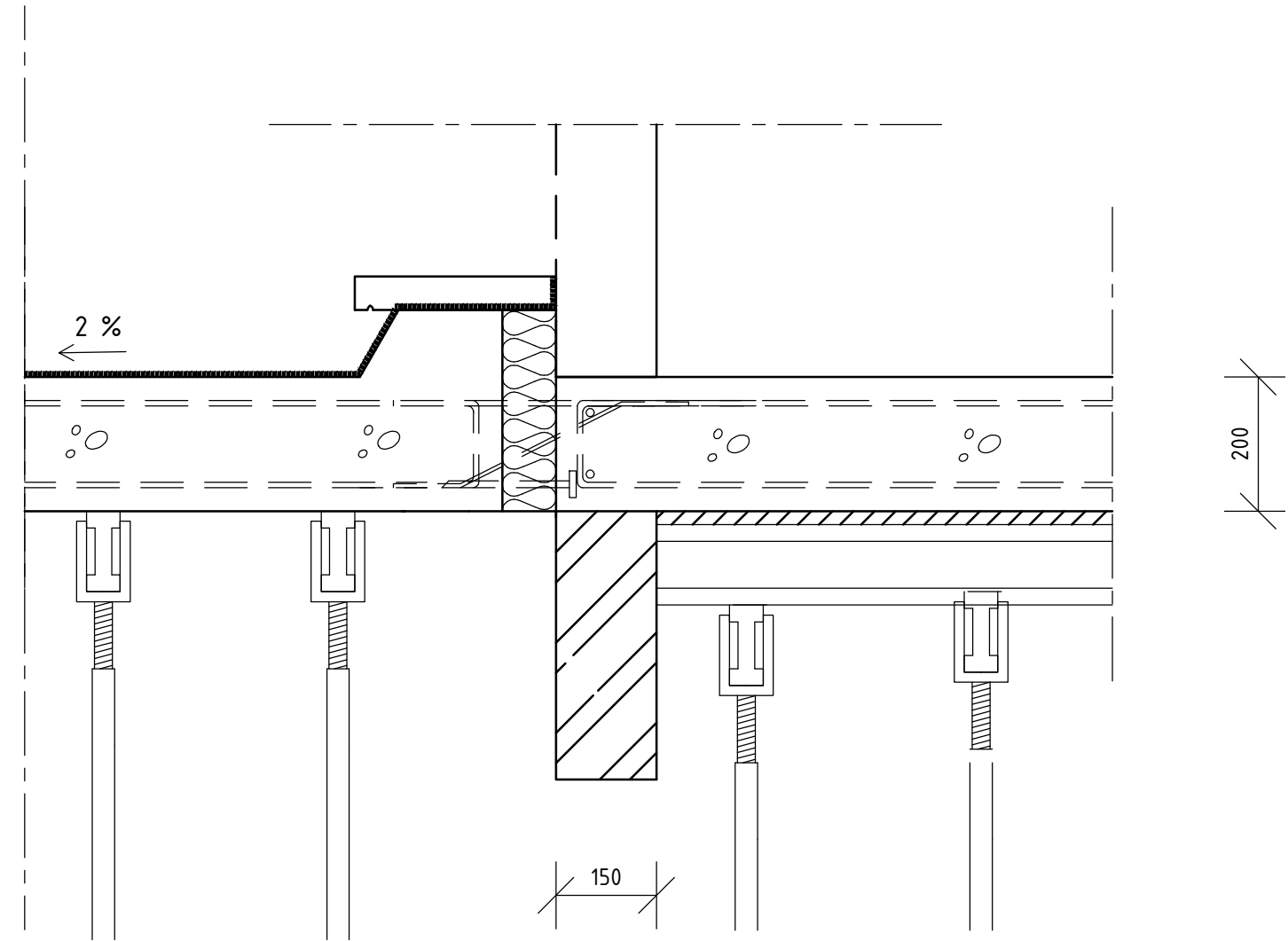

Kaupunginosa	Kortteli/tila	Tontti/rno	Viranomaisten merkintöjä
AALST			
Rakennusoimenpide			Piirustuslaji
NEW CONSTRUCTION			DETAILED STUDY PARTS 5-6
Rakennuskohde			Piirustuksen sisältö
BACHELOR'S FINAL PROJECT 2017			BALCONY - WALL - FLOOR CONNECTION
		Allekirjoitus	Suunnitteluala, työnnumero ja piirustusnumero
			Muutos
Päiväys, suunnittelija, nimen selvennys ja koulutus			Yhteyshenkilö
06.06.2017, Jesse Kytömäki, engineer			Tiedosto

# 7 Facade and thermal insulation

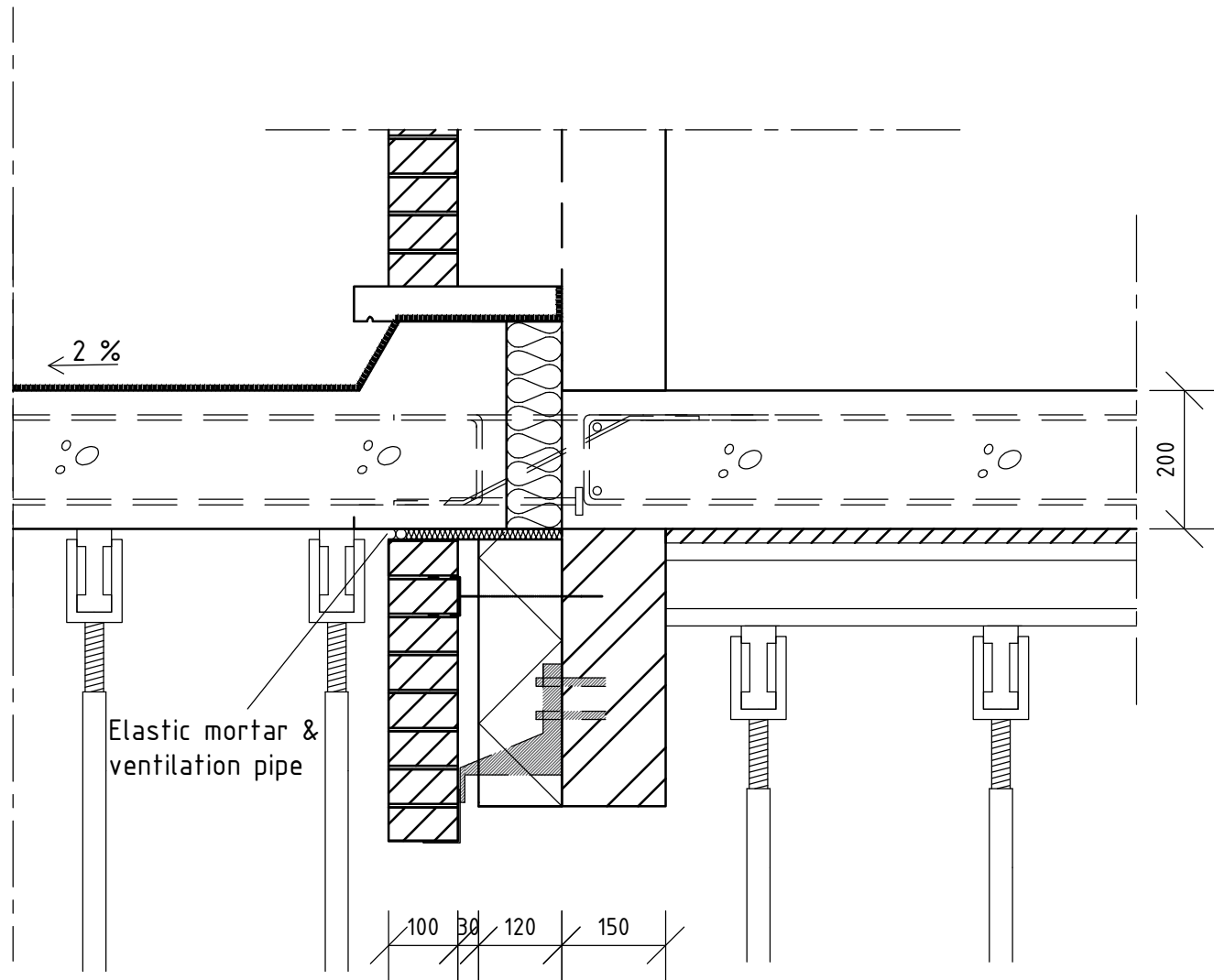

# 8 Doors and windows

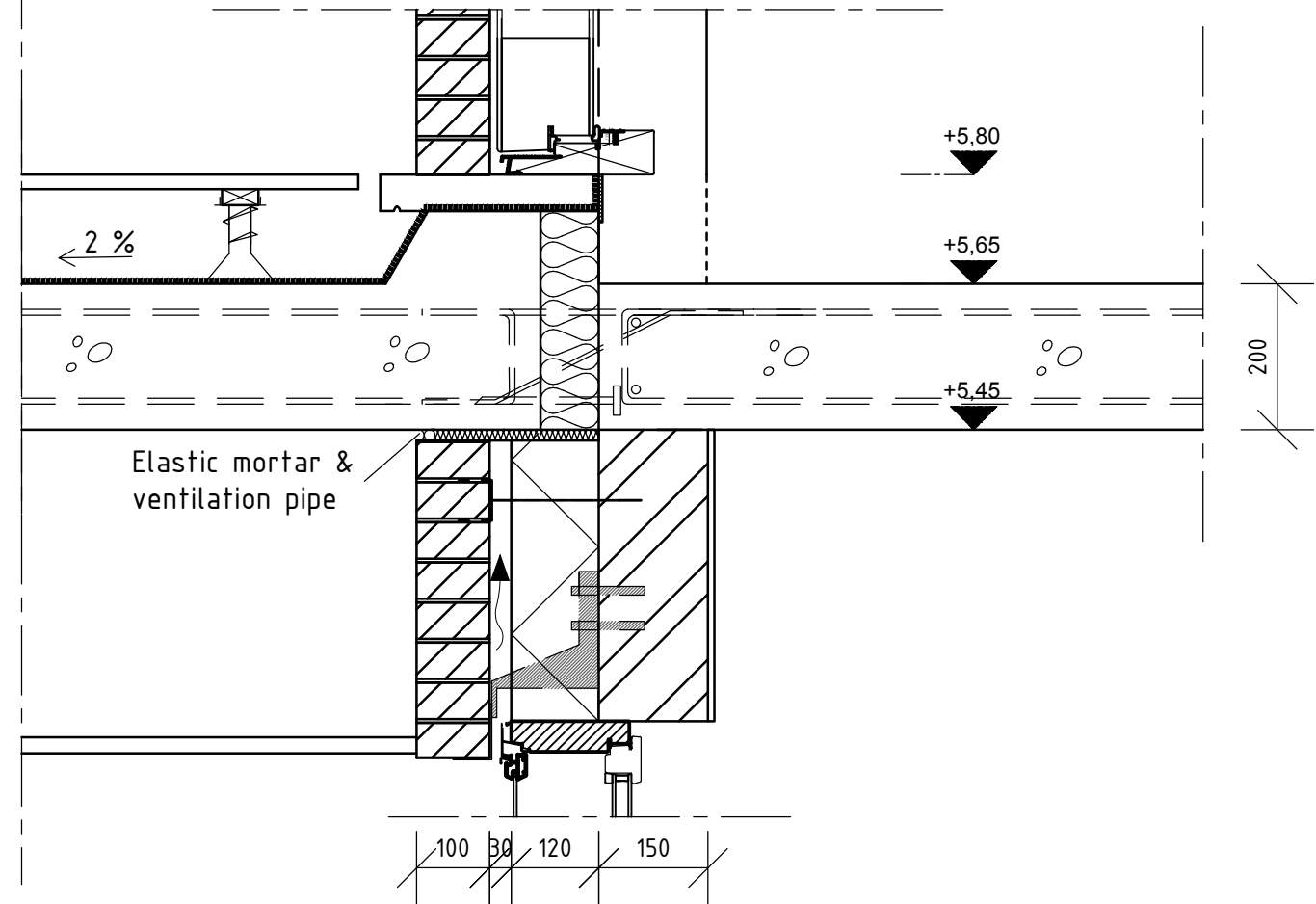

Kaupunginosa <b>AALST</b>	Kortteli/tila	Tonnti/mo	Viranomaisten merkintöjä
Rakennusoimenpide <b>NEW CONSTRUCTION</b>			Piirustuslaji <b>DETAILED STUDY PARTS 7-8</b> Juoks.no
Rakennuskohde <b>BACHELOR'S FINAL PROJECT 2017</b>			Piirustuksen sisältö <b>BALCONY - WALL - FLOOR CONNECTION</b> Mittakaavat <b>1 : 10</b>
		Allekirjoitus	Suunnittelualue, työnnumero ja piirustusnumero Muutos
Päiväys, suunnittelija, nimen selvennys ja koulutus <b>06.06.2017, Jesse Kytömäki, engineer</b>			Yhteyshenkilö Tiedosto

# 9 Planking of the balcony

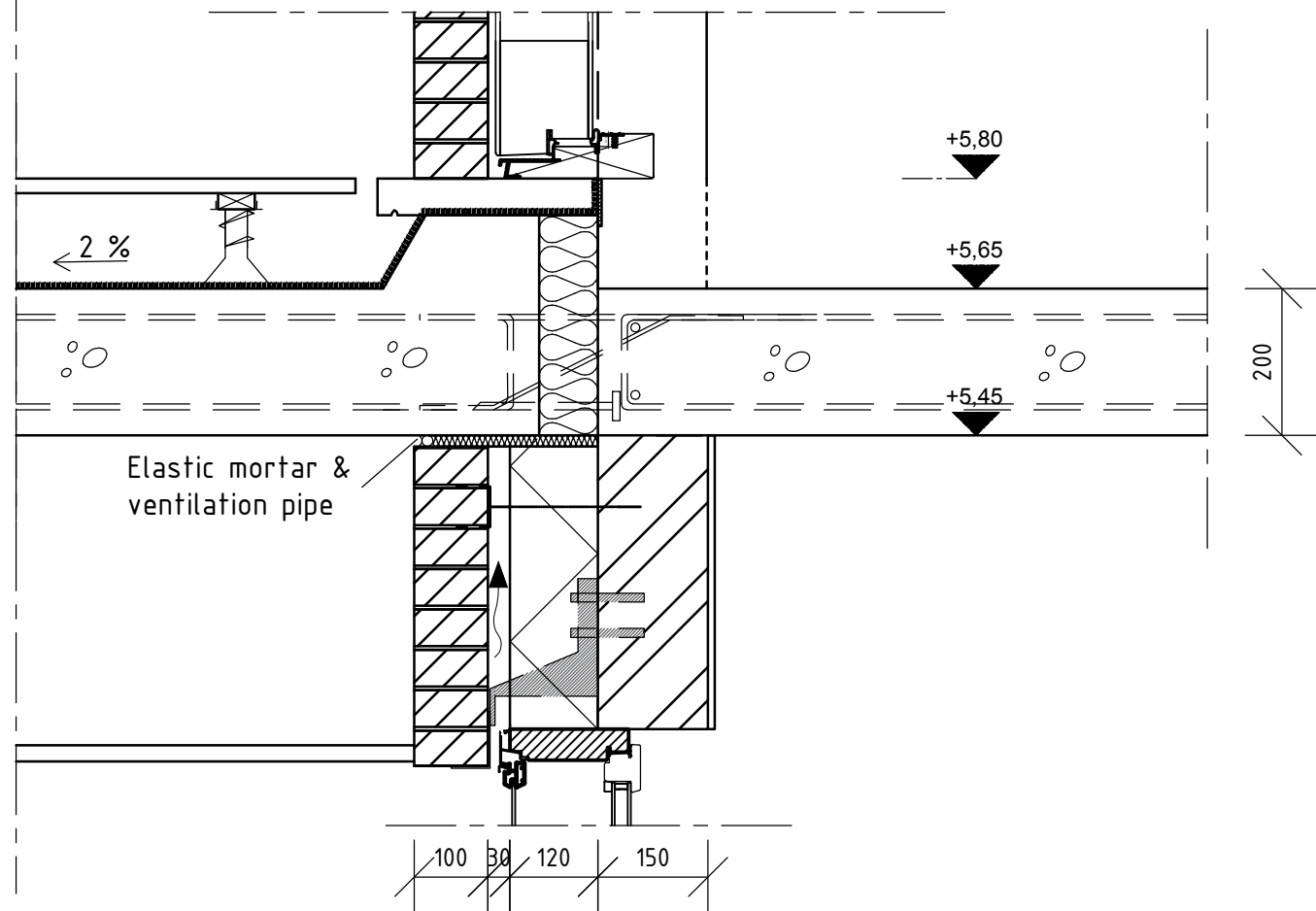

# 10 Situ concrete

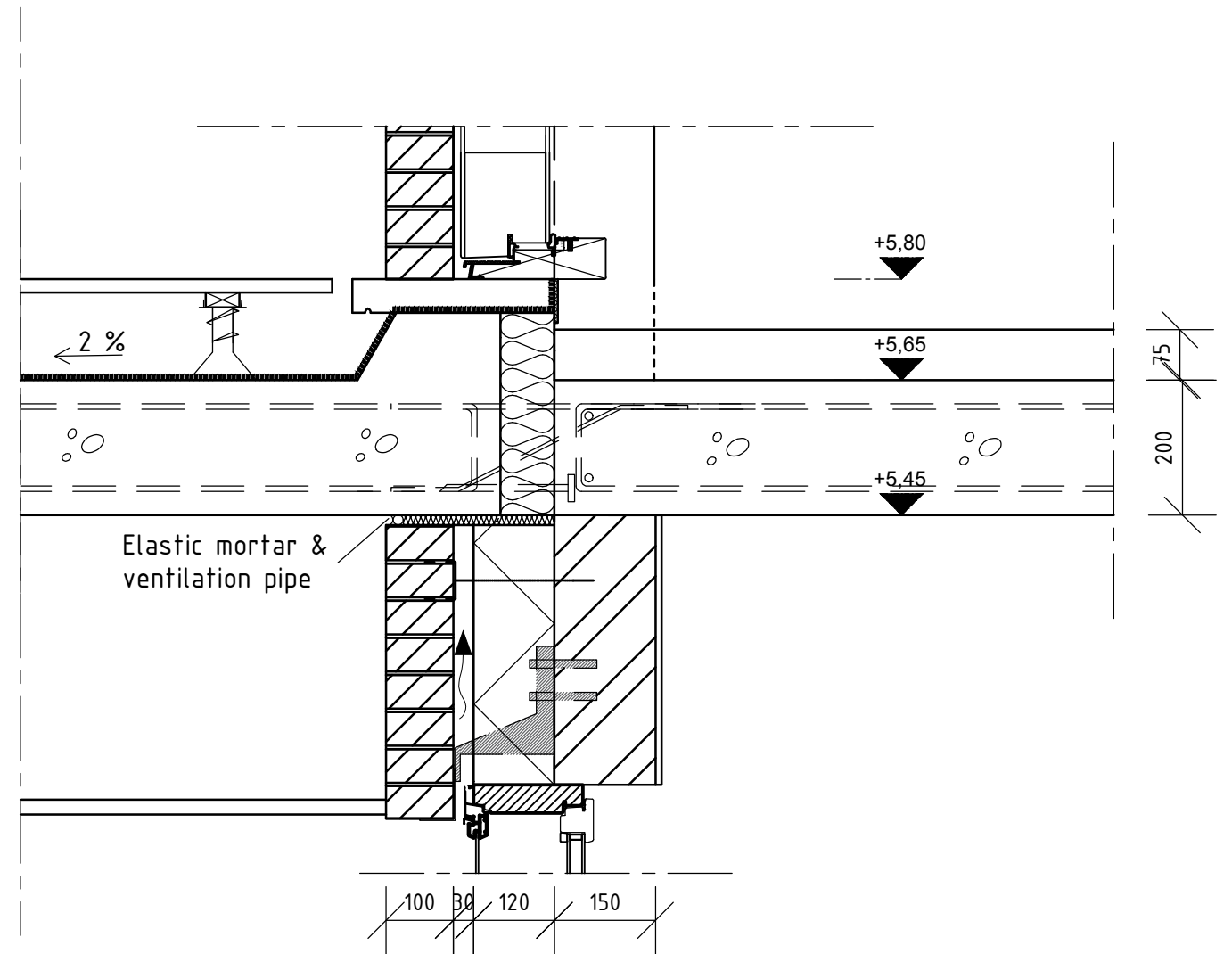

Kaupunginosa <b>AALST</b>	Kortteli/tila	Tonnti/m <sup>2</sup>	Viranomaisten merkintöjä
Rakennusoimenpide <b>NEW CONSTRUCTION</b>			Piirustuslaji <b>DETAILED STUDY PARTS 9-10</b>
Rakennuskohde <b>BACHELOR'S FINAL PROJECT 2017</b>			Piirustuksen sisältö <b>BALCONY - WALL - FLOOR CONNECTION</b>
		Allekirjoitus	Suunnitteluala, työnnumero ja piirustusnumero
Päiväys, suunnittelija, nimen selvennys ja koulutus <b>06.06.2017, Jesse Kytömäki, engineer</b>			Yhteyshenkilö Tiedosto

# 11 Acoustic insulation

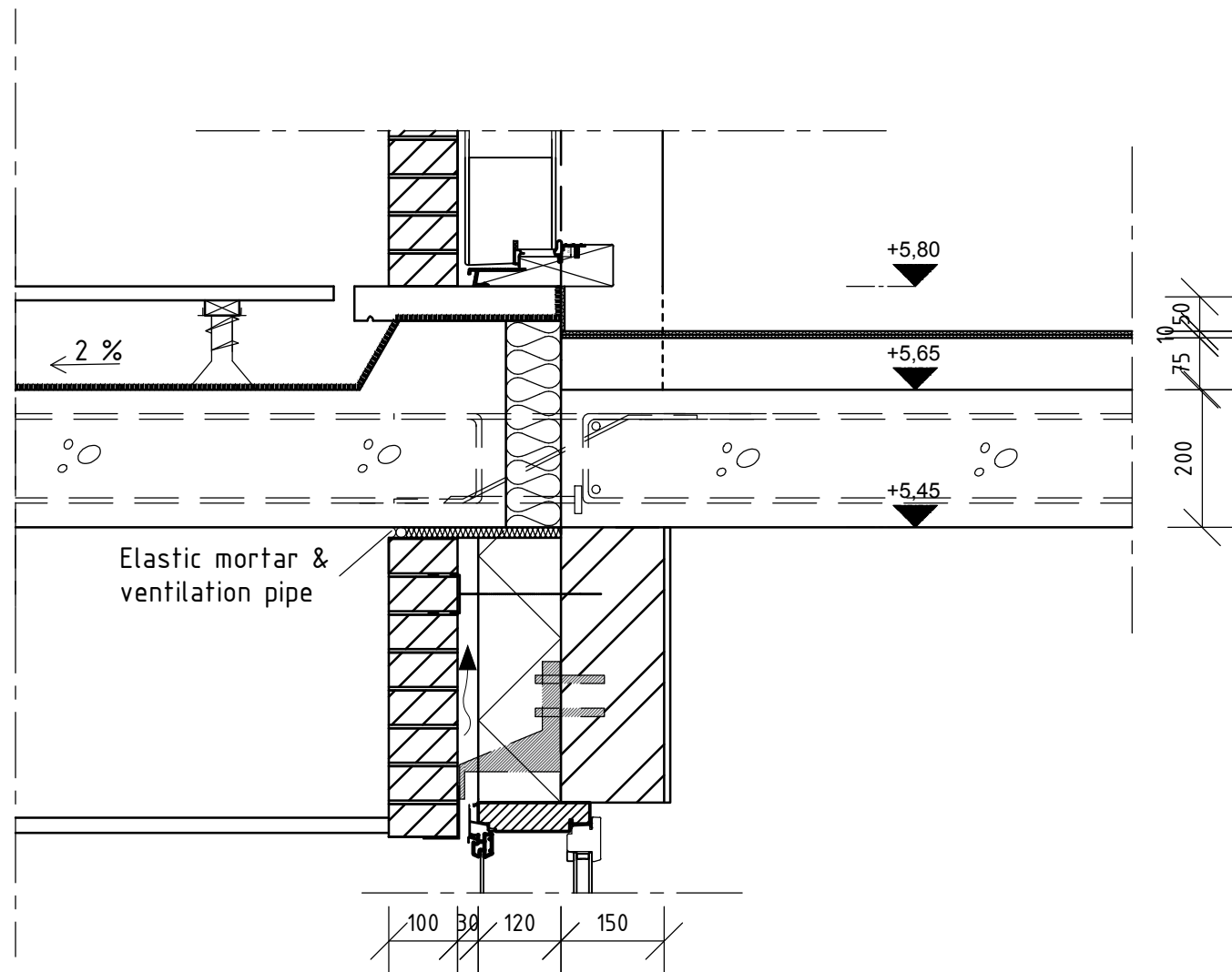

# 12 Situ concrete

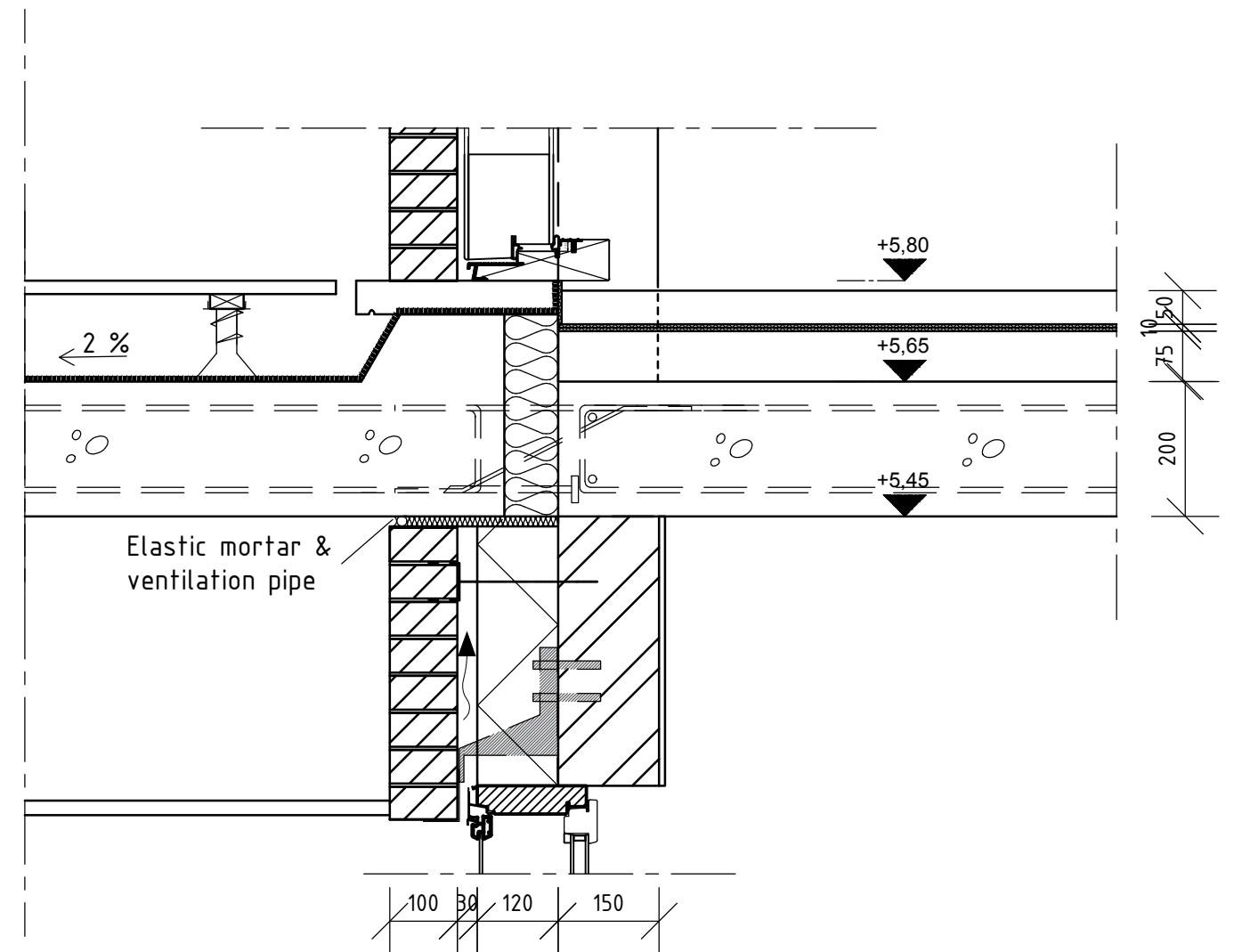

Kaupunginosa	Kortteli/tila	Tontti/rno	Viranomaisten merkintöjä
AALST			
Rakennusoimenpide			Piirustuslaji
NEW CONSTRUCTION			DETAILED STUDY PARTS 11-12
Rakennuskohde			Piirustuksen sisältö
BACHELOR'S FINAL PROJECT 2017			BALCONY - WALL - FLOOR CONNECTION
		Allekirjoitus	Suunnitteluala, työnnumero ja piirustusnumero
			Muutos
Päiväys, suunnittelija, nimen selvennys ja koulutus			Yhteyshenkilö
06.06.2017, Jesse Kytömäki, engineer			Tiedosto

# 13 Finishing works of the floor

## FLOOR

Floating floor treatment  
 Situ concrete 50mm type c20/25 S2  
 Acoustic sound proofing 2x5mm YELOfon HD5  
 Situ concrete 75mm type C20/25 S2  
 Situ concrete 200mm type C20/25 S2  
 Ceiling material

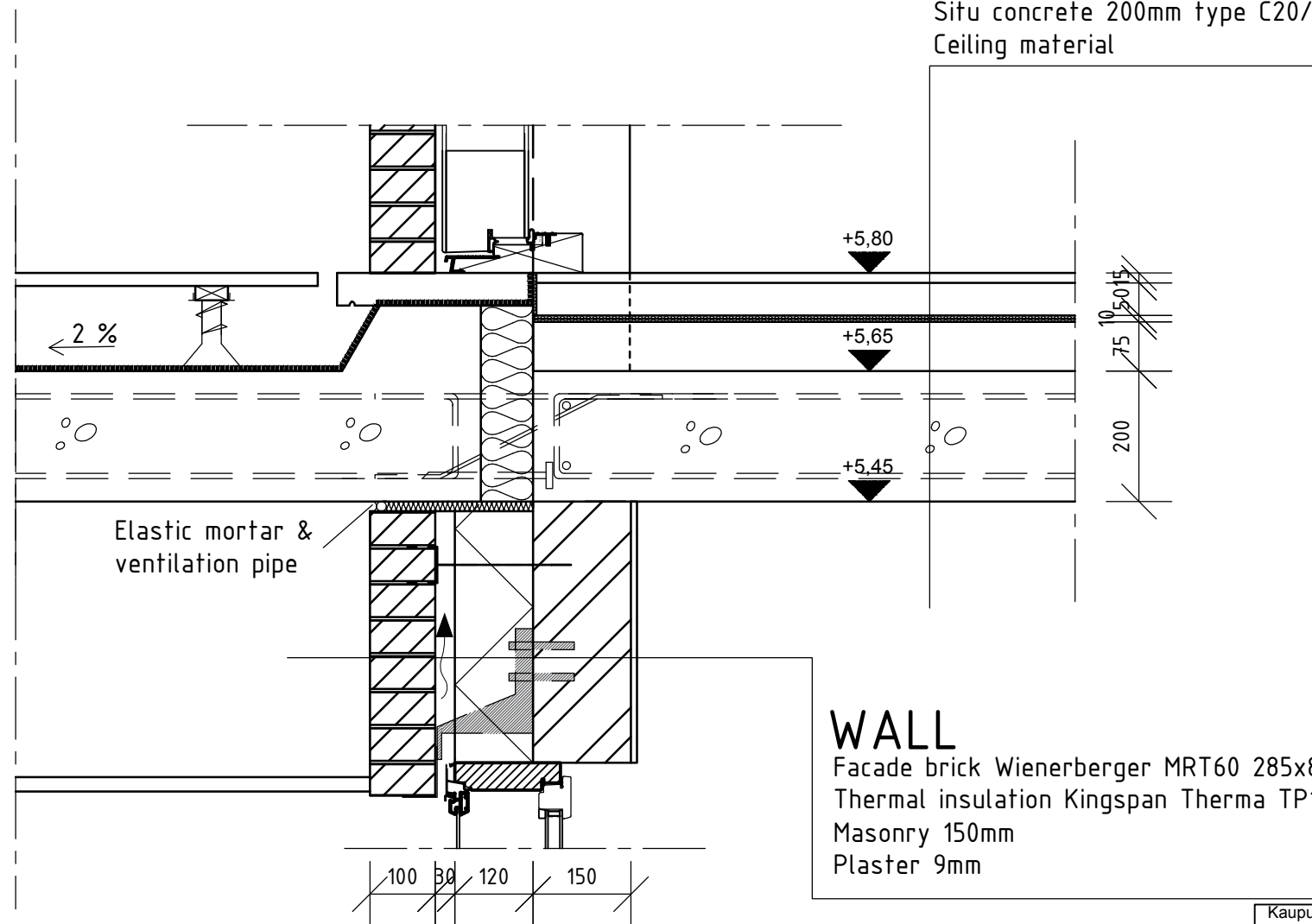

## WALL

Facade brick Wienerberger MRT60 285x85x60mm  
 Thermal insulation Kingspan Therma TP10 120mm  
 Masonry 150mm  
 Plaster 9mm

Kaupunginosa	Kortteli/tila	Tontti/rno	Viranomaisten merkintöjä
AALST			
Rakennusoimenpide			Piirustuslaji
NEW CONSTRUCTION			Juoks.no
Rakennuskohde			DETAILED STUDY PART 13
BACHELOR'S FINAL PROJECT			Piirustuksen sisältö
2017			Mittakaavat
			BALCONY - WALL - FLOOR
			1 : 10
			CONNECTION
		Allekirjoitus	Suunnittelualue, työnnumero ja piirustusnumero
			Muutos
Päiväys, suunnittelija, nimen selvennys ja koulutus			Yhteyshenkilö
06.06.2017, Jesse Kytömäki, engineer			Tiedosto

# Construction technique used in Belgium

## WALL

Facade brick Wienerberger MRT60 285x85x60  
 Air cavity 30mm  
 Thermal insulation Kingspan Therma TP10 120mm  
 Masonry 150mm  
 Plaster 9mm

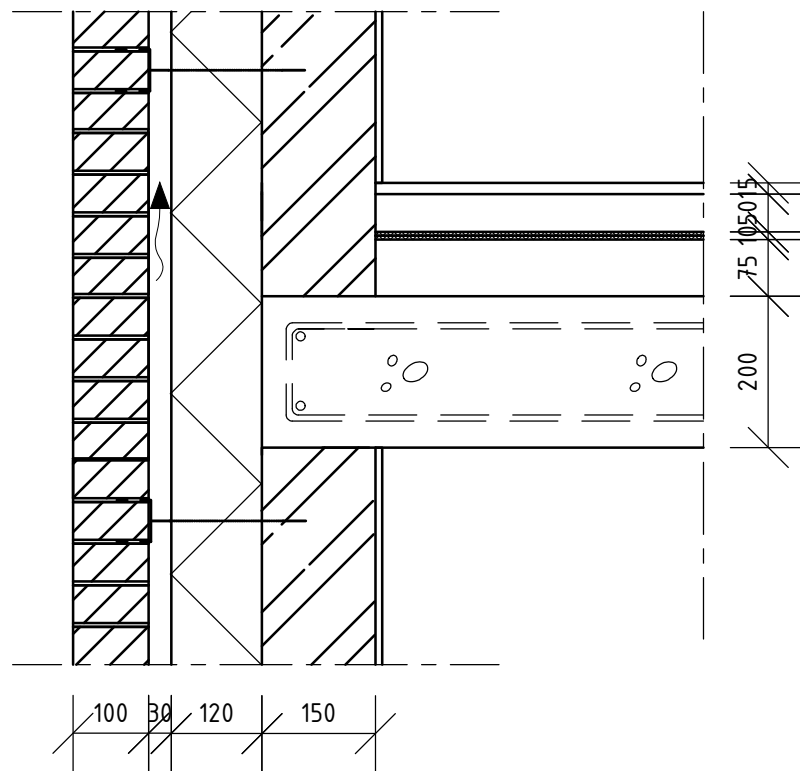

## FLOOR

Floating floor treatment  
 Situ concrete 50mm type c20/25 S2  
 Acoustic sound proofing 2x5mm YELOfon HD5  
 Situ concrete 75mm type C20/25 S2  
 Situ concrete 200mm type C20/25 S2  
 Ceiling material

## WALL

Facade brick Wienerberger MRT60 285x85x60  
 Air cavity 30mm  
 Thermal insulation Kingspan Therma TP10 120mm  
 Masonry 150mm  
 Plaster 9mm

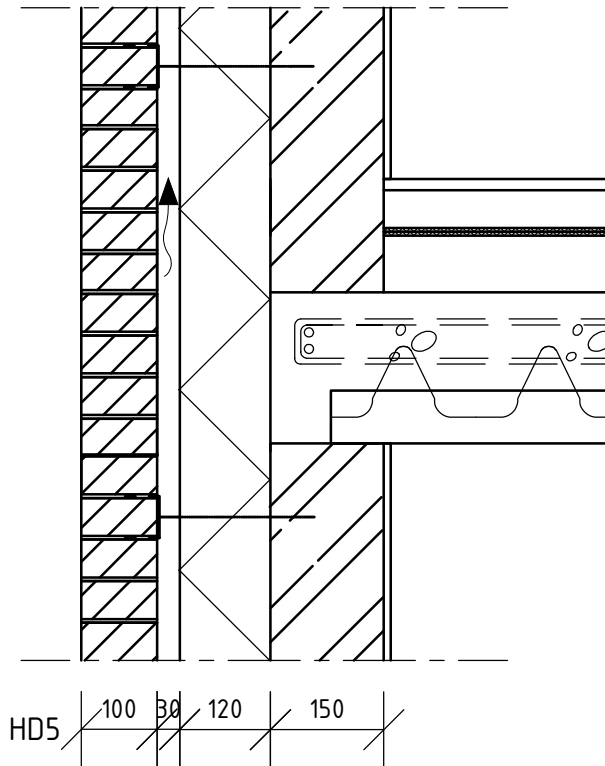

## FLOOR

Floating floor treatment  
 Situ concrete 50mm type c20/25 S2  
 Acoustic sound proofing 2x5mm YELOfon HD5  
 Situ concrete 75mm type C20/25 S2  
 Situ concrete 130mm type C20/25 S2  
 Prefabricated slab 70mm  
 Ceiling material

Kaupunginosa	Kortteli/tila	Tontti/mo	Viranomaisten merkintöjä
Aalst	Louis D'Haeseleerstraat		
Rakennusoimenpide			Piirustuslaji
NEW CONSTRUCTION			Juoks.no
Rakennuskohde			Piirustuksen sisältö
BACHELOR'S FINAL PROJECT			Mittakaavat
2017			DETAILS 1 & 2
		Allekirjoitus	Suunnitteluala, työnnumero ja piirustusnumero
			Muutos
		Päiväys, suunnittelija, nimen selvennys ja koulutus	Yhteyshenkilö
		24.5.2017, Jesse Kytömäki, engineer	Tiedosto

# Construction techniques used in Finland

## FLOOR

Floating floor treatment  
Situ concrete 75mm type C20/25 S2  
Hollow core slab 265mm, type O27

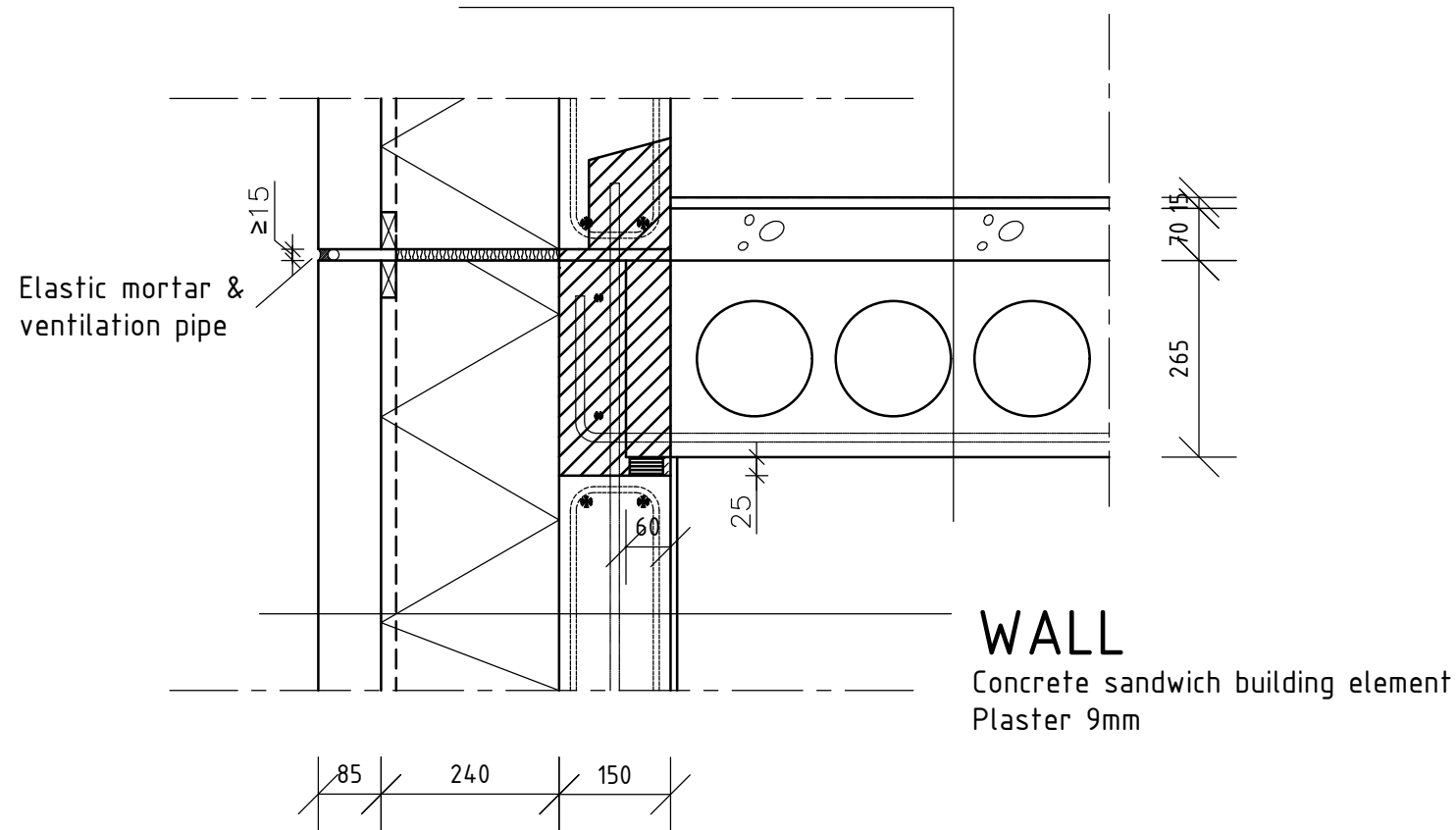

## FLOOR

2xGypsum board Gyproc GL15  
Floor supporting beams, 250x50mm k600  
Boarding 22x100mm k300  
Gypsum board Gyproc GN13

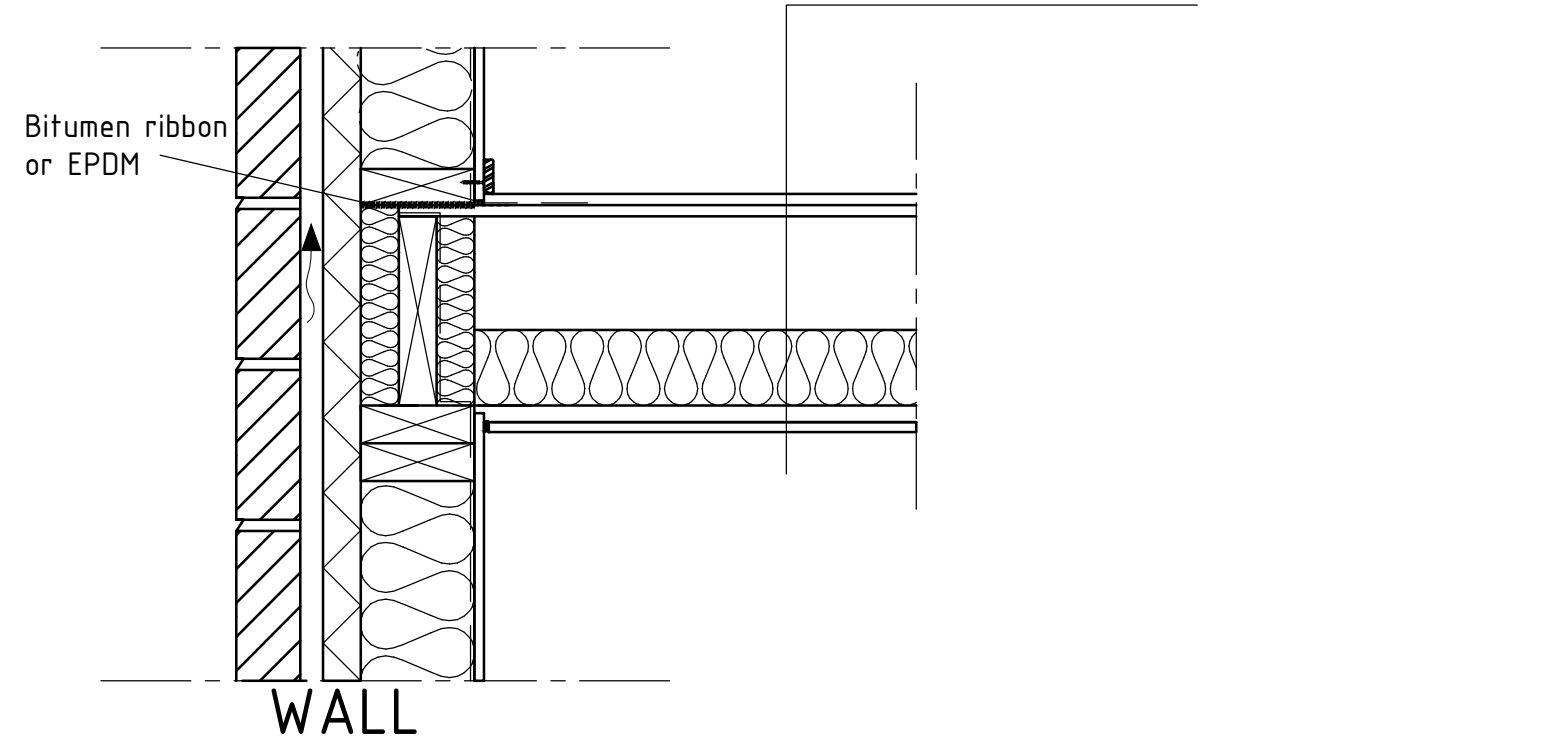

Kaupunginosa	Kortteli/tila	Tontti/mo	Viranomaisten merkintöjä
Aalst	Louis D'Haeseleerstraat		
Rakennusoimenpide	NEW CONSTRUCTION		Piirustuslaji COMPARATIVE STUDY Juoks.no
Rakennuskohde	BACHELOR'S FINAL PROJECT 2017		Piirustuksen sisältö Detail 3 & 4 Mittakaavat 1 : 10
		Allekirjoitus	Suunnitteluala, työnnumero ja piirustusnumero Muutos
Päiväys, suunnittelija, nimen selvennys ja koulutus	24.5.2017, Jesse Kytömäki, engineer		Yhteyshenkilö Tiedosto