



VAASAN AMMATTIKORKEAKOULU
VASA YRKESHÖGSKOLA
UNIVERSITY OF APPLIED SCIENCES

Muftau Raheem

INVESTIGATION, INSTALLATION AND
IMPLEMENTATION OF A CONTENT
MANAGEMENT SYSTEM

Technology and Communication

2010

VAASAN AMMATTIKORKEAKOULU
UNIVERSITY OF APPLIED SCIENCES
Degree Programme of International Business

ABSTRACT

Author	Muftau Raheem
Title	Investigation, Installation and Implementation of A Content Management System
Subtitle	Focus on Drupal
Year	2010
Language	English
Pages	41
Name of Supervisor	Johan Dams

This thesis is meant to provide an alternative solution to implementing a content management system in an European Union project, OpenKvarken co-ordinated by Vaasa Centre of Open source solutions. The target was to implement a more scalable, robust and flexible system as compared to initially implemented system which cost them losing their entire database when the system couldn't meet up with their demands. It therefore becomes inevitable to get a more reliable free and open source content management system.

In order to resolve this, Drupal being an open source content management system will be the focus of the study. It will be thoroughly researched in to based on VCOSS specifications which are mainly getting a framework that is capable of managing a web portal with features specified, web booking, web shop and an intranet system for collaboration within an organisation.

The output from this thesis will determine if Drupal will be used as the primary CMS of OpenKvarken or not.

Keywords Drupal, Free and Open Source, Content Management System

Table of Contents

1	INTRODUCTION	8
1.1	Open Source	9
1.2	Introduction to Content Management System (CMS).....	10
2	SERVER/DEVELOPMENT ENVIRONMENT	11
2.1	Operating System	11
2.2	Importance of a LAMP Server?	11
3	STRUCTURE OF DRUPAL.....	12
4	INVESTIGATION BY FUNCTION.....	15
4.1	Drupal Installation	15
4.2	Module Installation.....	16
4.3	Theme Installation	17
4.4	Putting up a content site	18
4.5	Administration point of view.....	19
4.6	Community Support	20
4.7	Site Maintenance	21
5	IMPLEMENTATION BY SCENARIOS.....	22
5.1	Web Portal	22
5.2	Intranet.....	27
5.3	Web Booking.....	30
5.4	Web Shop	36
6	CONCLUSION.....	38
7	LIST OF REFERENCE	41

List of Figures

Figure 1. Operation of LAMP	12
Figure 2. Drupal Theme File structure	13
Figure 3. Module components.....	14
Figure 4. Drupal Structure.....	14
Figure 5. Drupal installation	15
Figure 6. Drupal module	17
Figure 7. Themes installation.....	17
Figure8. Simple Content Setup	18
Figure 9. RSS Aggregator module	24
Figure 10. Search and Statistics module	24
Figure 11. login settings, Admin view.....	24
Figure 12. Navigational maps.	25
Figure 13. JQuery MapHighlight Admin View	26
Figure 14. Video Module and sub modules	27
Figure 15. Intranet Home with recent blog post and recent comments	29
Figure 17. Polls to vote and recent blog posts	30
Figure 18. How individual Poll looks like	30
Figure 16. Forum page with their respective discussion topics	29
Figure 19. Simple Reservation Admin View	31
Figure 20. Simple Reservation User's View	32
Figure 21. Planyobooking Reservation	33
Figure 22. Casa Brio Selected	34
Figure 23. User Li Di making reservation	35
Figure 24. Admin View of the reservations	35

Figure 25. Catalog Menu with all other classification 37

Figure 26 Payment method accepted 38

List of Tables

Table 1. Intranet Modules	28
Table 2. WebShop Catalogue and Products	36

ABBREVIATIONS

API	Application Program Interface
CCK	Content Construction Kit
CMS	Content Management System
DBMS	Database Management System
FOSS	Free and Open Source Software
GPL	General Public Licence
HTML	Hypertext Mark-up Language
HTTPD	Hypertext Transfer Protocol Daemon
IIS	Internet Information Service
LAMP	Linux Apache MySQL PHP
LOS	Linux Operating System
MySQL	My Structured Query Language
OSCMS	Open Source Content Management System
OS	Open Source
SSL	Secure Socket Layer
URL	Universal Resource Locator
VCOSS	Vaasa Centre of Open Source Solutions
WYSIWYG	What You See Is What You Get

1 INTRODUCTION

Vaasa Centre of Open Source Solutions (VCOSS) is an open innovation centre where several open source solutions for educational sector, private sectors, and public sectors are developed and customized to meet with the desired target. VCOSS has been involved in several projects within those earlier mentioned sectors some of which includes Migration Strategy for Local governments, company portal within Umea and Vaasa, 20 server solutions for educational sector, public administration and private sectors and many more. All of these projects are embed in the European Union project, OpenKvarken.

I had my practical training (Industrial Experience) with the Centre. As at that time there was a crash with the www.openkvarken.fi database and therefore there was need for migration to a more scalable one. My tasks then was to setup a database (MySQL), Install a content management system which is Drupal, study the system from the administrative view to the front end and finally implement it based on the VCOSS' specifications which includes a framework that allows setting up of a simple web portal without complexity and enriched with videos, newsletters, navigational maps, easy editing, access restrictions, Gallery support, statistics and well indexed portal for easy search. Another specification was having an intranet system that allows for collaboration and idea sharing within an organisation. A web booking and web shop will also be a focus as specified. The web booking will allow for making reservations of items or other things as they would want to while the web shop is meant to create a means of sales with secured of means of transaction since it involves several user's information.

The focus of this thesis will be to investigate and research in to Drupal, an Open source content management system and know if it is able to meet up with the needs of VCOSS as specified above. As at when this thesis ends (may 2009), VCOSS has the OpenKvarken portal ready to the public. OpenKvarken has executed some of the things implemented during the study of the thesis as it caters for the present needs and possible future growth were also taken care of because it had already been looked into during the thesis, It will only require VCOSS to implement it when they are ready to add more features.

1.1 Open Source

When the word Free and Open Source Software (FOSS) is heard, a lot of thoughts keep running in several minds this could be software with no support, no documentation, no money attached, complete access to the source code and lots of thoughts. However, there is more to it and some things need be taken into consideration. FOSS refers to software which had been developed without a proprietary lock for ease of use, redistribution and modification to meet up with the desired goal. In order to ensure the integrity of the FOSS, OSI (Open source Initiative) has made some yardsticks for certifying software as OS based on the following:

- ❖ Free Redistribution with no constraint to selling it or giving it out.
- ❖ Easy access to the access code when the program is released so as to allow for modification.
- ❖ Derived works meaning allowing for modifications and distribution.
- ❖ A derived work from FOSS could be renamed and restrict the source code to be distributed in modified form.
- ❖ The software must avoid all forms of discrimination against person or group of people.
- ❖ There shouldn't be restriction as to where to use the software be it in genetic research or business purposes.
- ❖ The software shouldn't make restrict all software to be used with it as FOSS.
- ❖ The Software should be Technology-Neutral.

(Open Source Definition, Open Source Initiative. Available from <http://www.opensource.org/docs/osd>)

Based on these standards set by the OSI, FOSS became interesting to be part of because it is not just available for modification, there had been several programmers spending a lot of resources to ensure its integrity and security. Finally it could be used for commercial purposes. Software with these features is referred to as having GPL (General Public Licence).

1.2 Introduction to Content Management System (CMS)

CMS could either be proprietary (i.e. vendor locked) or OS. The focus of this thesis is based on the OSCMS (Open Source Content Management System). The FOSS community has been working tirelessly in ensuring that programming as known to be scary by most people is being simplified by providing flexible frameworks for making several applications. This framework reduces the rigor involved in software development.

Content Management System is a framework that facilitates the organisation, creation, manipulation, management, look, content and administration through a restricted role access to ensure a dynamic running portal (Journal of the European Association for Health Information and Libraries 2008, Vol. 4(3) Drop in: Drupal for Libraries, Patrice Chalon, Belgian Health Care Knowledge Centre). *“The CMS increases overall operational efficiency through the automation of customized content processing via rules management interface and extensible workflow”* (Ericsson highlights watchpoint CMS, April 2010).

The advantage of having an OSCMS is that one is attached to a community of professionals who are ready to assist with all resource at their disposal should one get stuck on the project at hand.

Drupal being the focus of the OSCMS in this thesis is a child of software development evolution as said earlier that came to be in 2002 when the source code was released to the public by Dries Buytaert (a Belgian Student), Drupal founder and project lead. *“Drupal provides a broad range of features and services including user administrations, publishing workflow, discussion capabilities, news aggregation, metadata functionalities using controlled vocabularies and XML publishing for content sharing purposes. It supports a wide range of web projects ranging from personal weblogs to large community-driven sites.”*(<http://www.drupal.org/project/drupal>) Drupal uses the MySQL and PHP technologies and has undergone several transitions and as the time of this thesis the latest release was Drupal 6.15.

2 SERVER/DEVELOPMENT ENVIRONMENT

2.1 Operating System

For this thesis, the development environment will be Linux Operating System (LOS) and Ubuntu 9.04 in particular. LOS has been chosen because it is a clone of the Unix operating system (UOS), LOS is free and hence need no expensive licence before making the entire system up and running. This among other things considered includes its stability, security and ability to manage processor resource. Since an operating system to co-ordinate the entire application is put in place, there is need to have a web server that responds to web browser request from clients. The Apache Hyper Text Transfer Protocol Daemon (HTTPD) is capable of handling this.

Within this development environment, MySQL will be the database application software to store data needed by the web server (Apache). MySQL is an OS Database Management System (DBMS) which is the *“world’s most popular bit of database software with over six million active installations worldwide”* (David Mercer, 2008). However, Drupal supports other databases like PostgreSQL as an alternative. Drupal was written in PHP which *“is a widely used general-purpose scripting language suited for web development and could be embedded in HTML”* (<http://php.net/index.php>). As at this time, the latest release was PHP 5.2.12.

2.2 Importance of a LAMP Server

This is a web application server which is a combination of FOSS projects which are Linux, Apache, MySQL and PHP, this will aid the design of a reliable, stable, secure, fast and economical development environment to build the server and the content management system. VCOSS is an OS solution centre, hence using the LAMP server is in conformity with its Open ideology. It should also be noted that based on Drupal’s dynamism and flexibility, it supports Internet Information Service as an alternative (IIS). The summary operations of the LAMP sever is described in Figure 1.

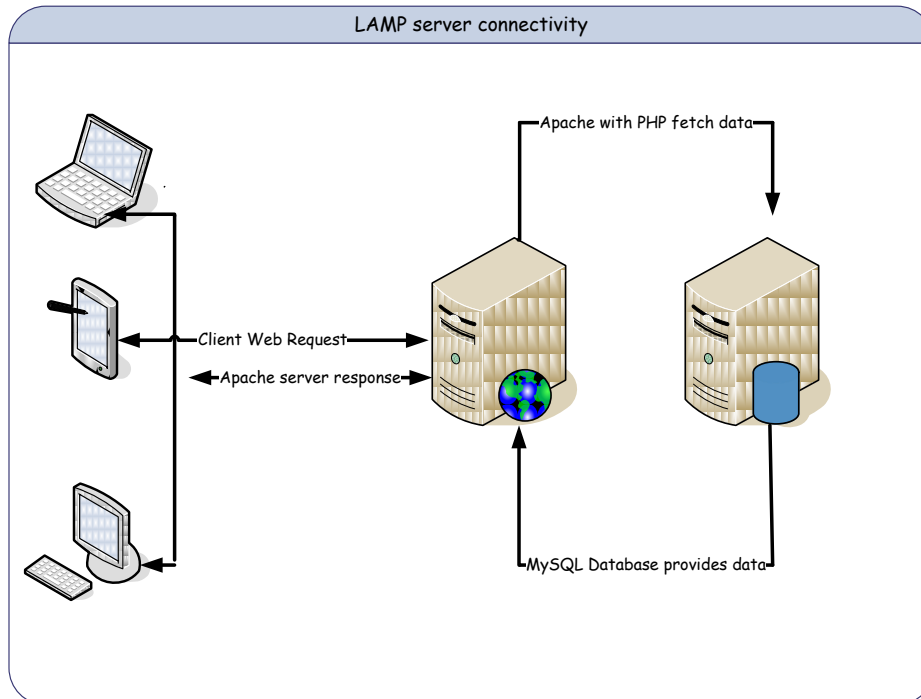

Figure 1. Operation of LAMP

(David Mercer, 2008 Building powerful and robust website with Drupal 6)

3 STRUCTURE OF DRUPAL

In using the Drupal CMS, there is need to understand its basic architecture. Drupal consist of the nodes, modules and the themes. The nodes are the contents themselves and hence every node belongs to a specific content type which determines how the node is being published and other attributes like allowing for comments. The default content types in Drupal are story and page.

The Drupal theme is a collection of several files written in PHP and CSS. It defines how the entire Drupal project being implemented will look like by defining the presentation layer. In other for Drupal to recognise the set of files as a theme, there must be .info file, Meta data, style sheets, java script and block regions.

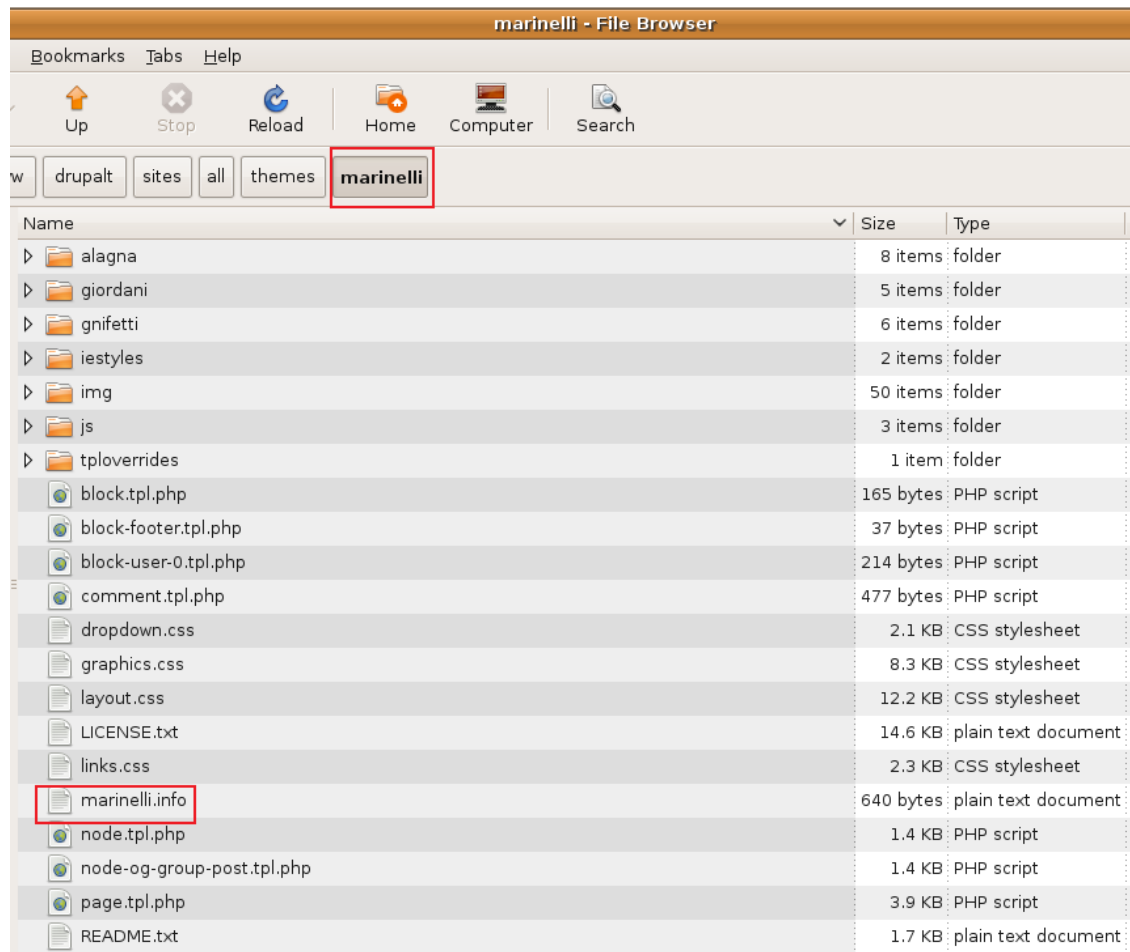

Figure 2. Drupal Theme File structure

Figure 2 above shows that the name of .info file determines the name of the theme and in this case there is marinelli.info hence the theme's name is Marinelli. A sub-theme could be created from the original theme such that the sub-theme inherits the attributes of the parent theme.

The Drupal module relates with the Drupal core based on hooks which are triggered when some certain action they depend on occurs. The module is composed of some files as illustrated in Figure 3.

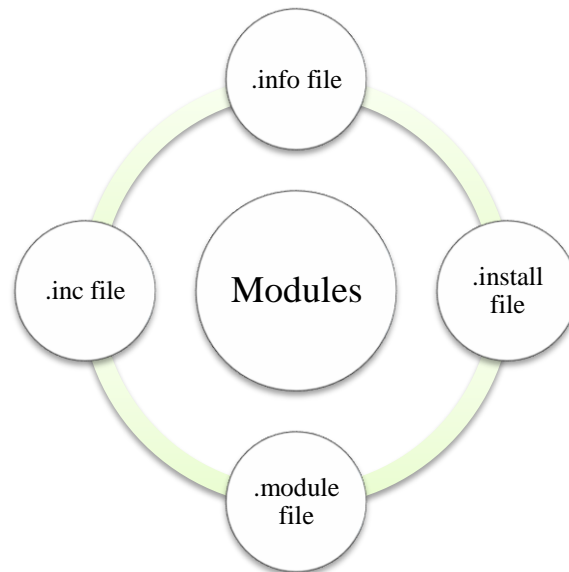

Figure 3. Module components

However, there are exceptions to some of these files but majority of the modules investigated have these files. The nodes, modules and themes are therefore interconnected as described in figure 4. It also shows the various transitions being undergone in Drupal from the raw content being handled by the various manipulations within the Drupal core then to the modules for enhanced functionalities, likewise the templates managing the outlook and feels of the Drupal project at hand. All of these are important stages in the development of a portal as presented with the OpenKvarken in Figure 4.

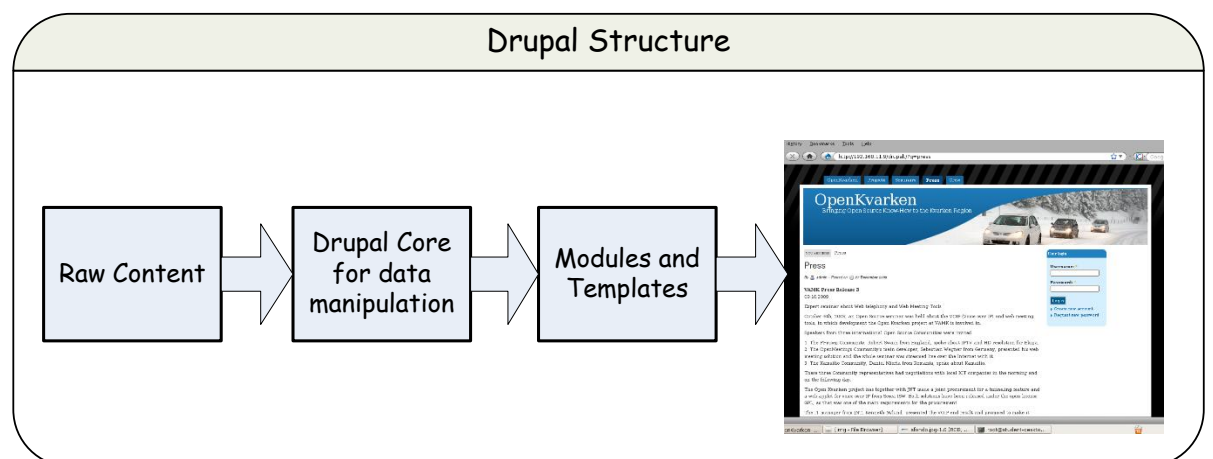

Figure 4. Drupal Structure

4 INVESTIGATION BY FUNCTION

As agreed by VCOSS, being a continuation of the practical training, there is need to critically investigate the system, this will enable VCOSS decide whether Drupal is able to provide its needs as specified and written above in the introduction. This is meant to check about the installation process, available module functionalities, theme installations, ease of use from administrative point of view and maintenance of the systems. It should be noted that this thesis was based on the release Drupal 6.15.

4.1 Drupal Installation

The major thing on focus as a yardstick is based on how technical it could be to set it up and the time it takes to have the system up and running.

The first thing here was to setup the MySQL database schema which Drupal will connect to and setup all of its components. Then the `.tar.gz` installation file was obtained from www.drupal.org after which the installation setup was done. Access to the root shell was of great assistance in ensuring some user rights with `chmod` on some of the installation files. The installation lasted within 12 minutes. Anyone familiar with the Linux shell, MySQL database and following the installation process could set it up.

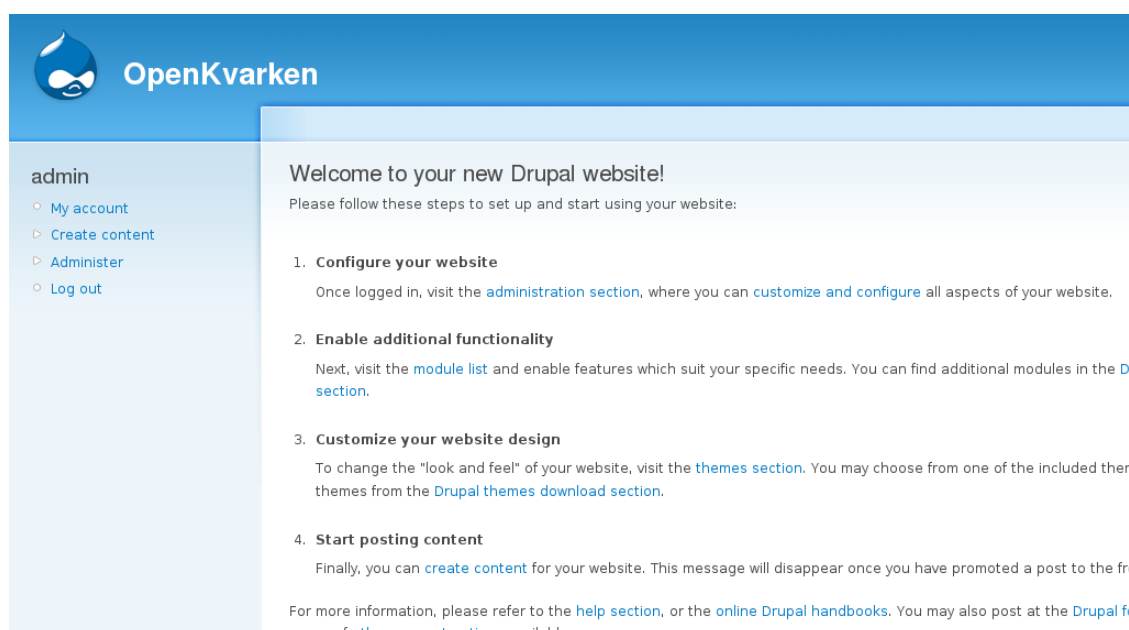

Figure 5. Drupal installation

Figure 5 above shows the default page presented by Drupal after the installation process. It displays various links that will aid the configuration of the content management system. The first was the administrative section, how to integrate more functionalities to Drupal using the modules, customization with themes and the posting of comments to the pages. Based on this, there could be dynamic presentation of the portal with several functionalities handled by the modules.

4.2 Module Installation

This is meant to look at the possibilities of extending the functionalities of the system. How easy it is to do with the possibilities of getting the desired results. By default, Drupal has been bundled with modules which are categorised in two; *core required and core optional*. The Core required modules are enabled by default, meaning they are compulsory modules for Drupal to work properly. These includes Block (controls the boxes around the main content), Filter (Handles the filtering of content in preparation for display), Node (Allows content to be submitted to the web for publish), User (Manages the user login registration) and System (Manages the general site configuration and administrators). As for the Core optional, these are meant to enhance the functionalities; the Drupal 6.15 has 28 installed modules out of which 3 were enabled already.

However having an additional module installation in Drupal is possible, once the `tar.gz` file is unzipped, the module folder is then moved to `/var/www/Drupal/sites/all/modules`. It should be noted that the modules folder in the `/all` wasn't there by default, it need to be created with `mkdir`. As from Drupal 5, module installations in Drupal are no longer installed in the Drupal root module folder. This is meant to avoid the new modules from interfering with the Drupal core. A module is automatically identified by Drupal once it is moved to the folder after which they are enabled from the administrative panel. It should be noted there is a readme file associated with each module to take care of its installation process in case it differs from the default way of installation. According to Figure 6, it shows newly installed module, jQuery Map Hilight and the Drupal core modules which are the Core-required and the Core-optional.

Core - optional			
Core - required			
Enabled	Name	Version	Description
<input checked="" type="checkbox"/>	Block	6.15	Controls the boxes that are displayed around the main content.
<input checked="" type="checkbox"/>	Filter	6.15	Handles the filtering of content in preparation for display.
<input checked="" type="checkbox"/>	Node	6.15	Allows content to be submitted to the site and displayed on pages.
<input checked="" type="checkbox"/>	System	6.15	Handles general site configuration for administrators.
<input checked="" type="checkbox"/>	User	6.15	Manages the user registration and login system.
Other			
Enabled	Name	Version	Description
<input checked="" type="checkbox"/>	jQuery Map Highlight	6.x-1.0	jQuery Map Highlight adds javascript mouseover highlighting of hotspots. Depends on: jQuery plugins (disabled)

Figure 6. Drupal module

4.3 Theme Installation

Themes are meant to enhance the appearance, feel and look of the CMS development. Different systems have various techniques involved in adding themes to it. Just like the case of the modules, Drupal has six default themes as well, however this doesn't limit the addition of other themes to it. To do this, a themes folder is created in `/sites/all/themes`. Once the download theme from drupal.org is unzipped and moved to themes folder, Drupal automatically identifies the newly installed theme. This is illustrated below in figure 7, it shows how the theme appears in the administrative section after being installed in the themes folder.

Screenshot	Name	Version	Enabled	Default	Operations
	Acquia Marina Acquia's Marina theme is ideal for blogs and community sites. Includes advanced theme settings and 15 flexible content regions for a variety of layouts. By TopNotchThemes	6.x-1.9	<input type="checkbox"/>	<input type="radio"/>	

Figure 7. Themes installation

Figure 7 shows that Acquia Marina had been installed and could be enabled from here, the administrative section.

4.4 Putting up a content site

It is important to easily setup web content with no complexity in doing it. So in doing this, we will be checking with the systems which of them could easily accomplish this. How much skills it could involve especially when the themes installation had been discussed earlier.

In setting up content on the new site, there was a challenge of getting to format the text because Drupal is not having a friendly interface to input text like the popular WYSIWYG. Just like it was pointed out earlier that Drupal has some default modules, however, that of text editing is missing. So to get started, it is required that the site administrator has a knowledge of HTML or install an easy editing module. After the installation of Drupal, it displays a page that points out how to setup content in the system. It isn't that straight forward at the beginning and would require studying the system for like two days to have an idea of how the system works.

Drupal having some default content types like story and page makes it easy to quickly publish contents. Drupal allows for a workflow that could make it easy specifying where the content could be published on the site. A simple site as shown in Figure 8 had been designed which could be developed to a more complex one.

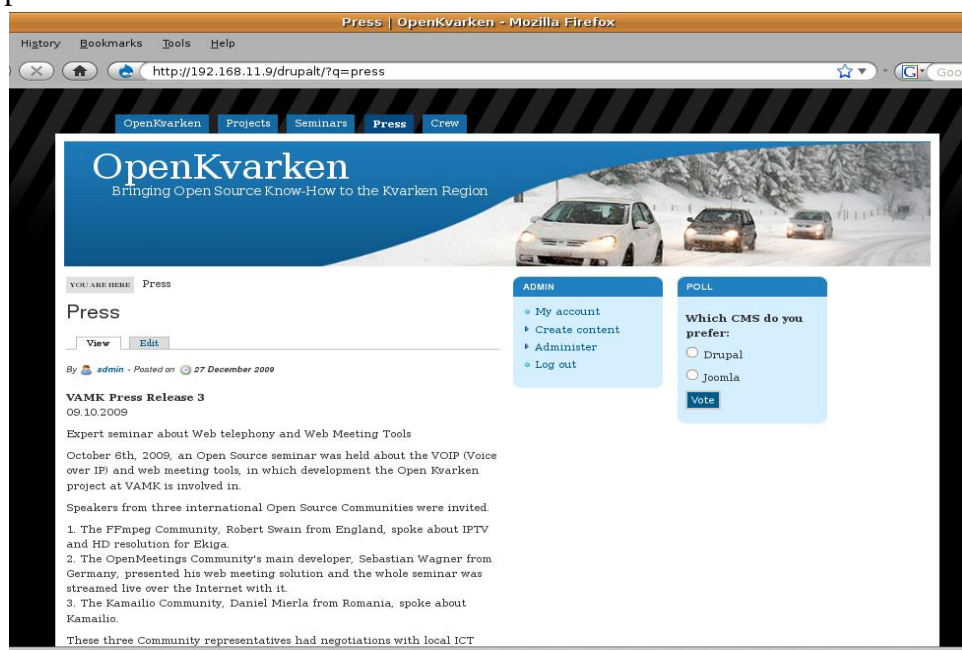

Figure8. Simple Content Setup

4.5 Administration point of view

When dealing with any content management system, it is important for the administrator to know how to manipulate around it. Knowing this will aid making necessary restriction rules, text and image manipulation, more so language support in creating a multilingual portal and the use of right content types where necessary. Hence the yardstick used here was based on the administrative interface, content editing, searching through content types, creating primary and navigation menu or links, access restrictions, image input and language support.

From the study, the Drupal administrative interface isn't GUI compared to other systems, rather it is more of text, except for some of its modules which have its user interface like CCK (Content Construction Kit) and Views. The admin panel is divided in to six which includes; Content Management, Site building, Site configuration, User Management, Reports and Help. The site building handles the block region configurations, Menus administration, Modules and themes. In general it takes care of the site's look and feels.

The content management aids the management of the site's post settings, taxonomy (classification and grouping) and content types. The Site configuration handles the basic site configuration options of some installed modules. It handles error reporting, clean URLs, allowed file systems on the site, input formats, performance, site information and many more.

There is a User management that takes care of the access rules, permissions, user settings roles and users in general. The Report section handles the log entries, available updates and status reports for the operation of the site and in case of any problem.

The Drupal core is lacking a WYSIWYG text editor, so using it requires the knowledge of HTML for a start or installs a WYSIWYG module such as TinyMCE or FCKEditor. With this, content editing becomes much easier as compared to using the HTML tags if the administrator isn't familiar with HTML. Drupal supports 179 languages by default which makes it easy to create a multilingual portal, in fact it supports my local dialect which is Yoruba (from

Nigeria). This version of Drupal which the thesis is based has the Finish and Swedish language included compared to older release I have worked with.

There is support for easy editing through the administrative content types if there is need to edit some published nodes among several content types like poll, story, page, forum, blog, news, Quiz, Rotor items and some other customized content types because Drupal allows to create one's content type to take care of personal needs. Drupal has some filtering features to make the editing easy.

Some problems were encountered in having images being presented, however there are several modules which takes care of this .Creating a menu link is easy to do in Drupal and hence all created nodes could be easily assigned to a particular menu link where it is meant to appear. Menu in Drupal could either be navigation, primary or a secondary link. The Navigation link is often visible by authenticated users and not anonymous users, primary links are like the tabs along the top while the secondary links play a lesser role compared to the primarily links.

Drupal provides adequate user management rules which includes access rules, which can access certain pages or make comments, user roles and functions, all of these makes it easy creating a secured portal and intranet system.

However, at this juncture it should be pointed out that Drupal isn't a straight forward system to use. It requires an extensive study and even some of its modules like Views require special attention to get going on it. Personally it took me close to three months because there is need to read several documentations and textbooks. More so, the best is to implement as one studies this actually assisted me a lot in meeting up with VCOSS needs.

4.6 Community Support

One of the challenges most likely to be faced when using any software is to have a support for it in case there are some bugs to be fixed. As for most proprietary or vendor locked applications, there are supports which has a fixed duration as covered by the purchased licence. This is not the case with the OS because there are lots of technical supports from the community of talented members who are willing to help in times of difficulties.

Drupal has a huge community with over 365,000 pages on its official website. It has a community of developers who constantly contribute modules, patches, themes, documentations to make its implementation easier and also forum moderators and participants that could also assist when there is need for help. This has actually got me going as well in the use of Drupal. Drupal has a team of developers dedicated to the security of its core and contributed modules some help with the translation, documentation, testing of some new features, marketing and of course some donate financially to the progress of Drupal.

I would recommend that VCOSS / OpenKvarken project also join the Finnish translation team on drupal.org. As at writing this, there were 13 members (which am one of them) with over 99% “*untranslation*” status. This will go a long way in assisting the Drupal community and the project as a whole.

4.7 Site Maintenance

For every portal or site there is need to have some certain routines which takes care of vulnerabilities and irregularities like database crash, outdated modules, taking care of some injections from external sources, updates and bug fixes likewise search engine optimization.

Drupal has a PHP script called cron.php which is part of the Drupal installed file. This makes Drupal to effect changes and updates in its core. A scheduled task needs to be set to run the cron.php script either in minutes, hours, days or months. In doing this, the community has contributed a module called the poormanscron which helps with the scheduling of the cron to run at certain intervals. In using modules and to stay out of bugs, Drupal has different versions of contributed modules, it is better to use the recommended releases as this had been tested so there is no need to wait for some patches to fix any bug.

Maintaining users is pretty cool as there could be restrictions on who could register on the site or even block some certain email domain from registering on the site. User roles could be easily defined and managed. Drupal fits well in this.

In search engine optimization, Drupal has a good search engine optimization by enabling the clean URL (i.e. removing the? q= after the main site), it makes the site indexed in the search engines.

5 IMPLEMENTATION BY SCENARIOS

At this juncture, the basic functionalities of Drupal had been examined, so there is need to integrate those functions together to know if it is capable of producing a complete system of web portal, web shop, web booking and intranet. This section will be looking at various scenarios as wanted by VCOSS to know if Drupal will fit in well to produce a well scalable and highly functional web shop, web portal, intranet and web booking systems. All of these have their respective criteria which will be discussed in details.

5.1 Web Portal

The Vaasa Centre of Open Source Solutions looks forward to getting a system to setup a comprehensive portal that enables the following:

Searching: The system should have indexed the entire content of the site, thereby allowing for adequate search of any keyword within the portal either by tags or adequate and logical grouping of the posts by users.

RSS (Rich Site Summary) Feed Site: Due to the endless and enormous resources out there in the internet, there is need to have a means to pull and have those resources in one place with adequate classification of various items being pulled. Hence, the portal should be able to pull the resources and make apt classification of individual item being pulled. This will also help in creating a dynamic web content on the portal. *Statistics:* With this VCOSS wants to know the number of hits on the OpenKvarken Portal.

User Login: The user login should be done such that, only the administrator could provide the username and password to the registered companies as partners.

Remote Website Display: With this they want all other websites to display within the OpenKvarken Portal.

Google Location: This is meant to allow companies link their address to Google map for their clients or interested person to locate them easily.

Clickable Maps.: This will allow for a map showing the region between Finland and Sweden be made clickable to allow for easier navigation and makes direct linking to various areas of the portal from the maps.

Video Support: Visual representation is one of the best ways information could be presented. It makes the portal attractive and keeps users to the pages because it is a form of entertainment even while passing across some information. So we are looking towards a portal capable of this.

Easy Editing(WYSIWYG): Setting up an easy HTML text editor in Drupal was a bit of trick. But carefully reading through the README.TXT of the FCKeditor, which is the installed module, setting up and administering becomes easy. This is one of the things lacking in Drupal Core as compare to other systems.

Custom Company Pages: Companies should be able to access their own pages from the portal with ability to create their own content themselves. This is also made possible since there an easy editing feature installed already.

Gallery Support: VCOSS would want to include all pictures created from seminars and conferences held during the OpenKvarken project on the portal. So a more robust system and suitable system will be appreciated.

In achieving all of above mentioned tasks,

First for the search functionality and proper indexing, the search module available with the Drupal installation was used. The poormanscron have been used to enable cron run at a scheduled time so that there could be proper indexing of every keyword on the portal which will aid the search functionality.

For the Rich Site Summary (RSS), we used the Aggregator module, this enables the pulling of contents from other open source websites. The statistics module had been used to log the access statistics of the portal.

Enabled	Throttle	Name	Version	Description
<input checked="" type="checkbox"/>	<input type="checkbox"/>	Aggregator	6.16	Aggregates syndicated content (RSS, RDF, and Atom feeds).
<input type="checkbox"/>	<input type="checkbox"/>	Blog	6.16	Enables keeping easily and regularly updated user web pages or blogs.

Figure 9. RSS Aggregator module

<input checked="" type="checkbox"/>	<input type="checkbox"/>	Profile	6.16	Supports configurable user profiles.
<input checked="" type="checkbox"/>	<input type="checkbox"/>	Search	6.16	Enables site-wide keyword searching.
<input checked="" type="checkbox"/>	<input type="checkbox"/>	Statistics	6.16	Logs access statistics for your site.

Figure 10. Search and Statistics module

Figure 9 and 10 shows the newly enabled modules of the portal which are aggregator, search and Statistics. All of this has various roles to play as discussed earlier.

The user login had been modified from the administrative panel, user management, user settings such that only the site administrator could create a new user account.

User settings

User registration settings

Public registrations:

Only site administrators can create new user accounts.

Visitors can create accounts and no administrator approval is required.

Visitors can create accounts but administrator approval is required.

Figure 11. Login settings, Admin view.

Figure 11 show that, Drupal gives three major ways of public registration to the portal as displayed. But for the purpose of this portal and meeting up with its requirements the first option had been chosen so that only the site administrator could add and create a user account.

In achieving the custom company pages, access was granted to all authenticated users in the company group to create story, pages, polls about their products and more so, format it in the way they that suits them most. But basically they were

able to dynamically update their portal without the aid of the administrator. However, additional services could be requested from the administrator.

Remote Website Display; based on the definition of VCOSS on this, it was later suggested that, having another website display in the OpenKvarken portal (parent window) wouldn't be nice because it will make the site too congested of traffic. However since the intent is to ensure that users are not made to navigate away from their portal. Hence, there links will be made to open in a new window. This we feel will still make the users have access to the OpenKvarken portal instead of having to leave it completely.

For the clickable maps the jQuery Map Hilight Module which adds JavaScript mouse over highlighting of hotspots to HTML image maps was used.



Figure 12. Navigational maps.

As shown above in figure 12, the red spots are the regions where the clickable maps have been applied. The regions were determined by knowing the x-y coordinates of the red spots. After it has been applied, the red spots have a red highlight when the mouse is moved over it as shown on the map for first red spot.

JQuery Map Hilight

jQuery Map Hilight Plugin Status

The Map Hilight jQuery plugin is available at: /sites/all/modules/jquery_plugin/jquery.maphilight.min.js

jQuery Map Hilight Plugin Settings

Be sure to add `class="jq_maphilight"` to the IMG tag of all image maps you want highlighted.

Fill:
 TRUE ▼
Specify whether or not the highlighted area should be filled.

Fill Color:

Specify the color of the fill. Use HTML # notation without the #.

Fill Opacity:
 ▼
Specify the opacity of the fill (0 = lightest, 10 = darkest).

Stroke (outline):
 TRUE ▼
Specify whether or not the highlighted area will be outlined.

Stroke Color:

Specify the color of the outline. Use HTML # notation without the #.

Stroke Width:

Specify the width of the outline in pixels.

Stroke Opacity:
 ▼
Specify the opacity of the outline (0 = lightest, 10 = darkest).

Fade:
 TRUE ▼
Specify whether or not the highlighting uses a fade transition.

Figure 13. JQuery MapHilight Admin View

Figure 13 shows several configurations which are enabled on the JQuery map highlight, if all of these as shown are enabled and values are assigned, it will make a good output for the navigational maps.

Figure 14 below shows the modules which had been enabled for the smooth implementation of the video support within the portal. In it, there was a Google video module which enables Google video support for the video module, the upload module, which enhances support for the uploaded video to be enabled within the video module configuration. In some cases, it might just be enough to have a link to a video intended to be uploaded on the portal, hence the URL video module is capable of enabling this feature.

Wouldn't it be nice to have a thumbnail appear for the uploaded video or having a YouTube video as the case may be, all of this could be made possible with the video image module and YouTube video module respectively, more of this could

be seen and implemented in the video module configuration from the administrative section of Drupal management.

Enabled	Name	Version	Description
<input checked="" type="checkbox"/>	Google Video	6.x-2.5-beta1	Enable Google video support for Video module. <i>Depends on: Video (enabled)</i>
<input checked="" type="checkbox"/>	Upload Video	6.x-2.5-beta1	Enable Uploaded video support for Video module. <i>Depends on: Video (enabled), Token (enabled)</i> <i>Required by: Video ffmpeg Helper (enabled)</i>
<input checked="" type="checkbox"/>	URL Video	6.x-2.5-beta1	Enable URL video support for Video module. <i>Depends on: Video (enabled)</i>
<input checked="" type="checkbox"/>	Video	6.x-2.5-beta1	Allows video nodes. <i>Required by: Video ffmpeg Helper (enabled), Google Video (enabled), Video Image (enabled), Video Multidownload (enabled), Video Opt Metadata (enabled), Video Params (enabled), Upload Video (enabled), URL Video (enabled), Youtube Video (enabled)</i>
<input checked="" type="checkbox"/>	Video ffmpeg Helper	6.x-2.5-beta1	Provide apis for ffmpeg. Simplify video nodes creation. <i>Depends on: Video (enabled), Upload Video (enabled), Token (enabled)</i>
<input checked="" type="checkbox"/>	Video Image	6.x-2.5-beta1	Enable thumbnails support for video module. <i>Depends on: Image (enabled), Video (enabled)</i>
<input checked="" type="checkbox"/>	Video Multidownload	6.x-2.5-beta1	Enable multiple file download in video module. <i>Depends on: Video (enabled)</i>
<input checked="" type="checkbox"/>	Video Opt Metadata	6.x-2.5-beta1	Enable addition of optional metadata on video nodes created by video module. Optional metadata are Video Bitrate, Audio Bitrate, Audio Sampling Rate and Audio Channels. <i>Depends on: Video (enabled)</i>
<input checked="" type="checkbox"/>	Video Params	6.x-2.5-beta1	Enable addition of html params to object generated by video module. Useful if you need to use swf videos which needs params to be passed. <i>Depends on: Video (enabled)</i>
<input checked="" type="checkbox"/>	Youtube Video	6.x-2.5-beta1	Enable Youtube videos support for Video module. <i>Depends on: Video (enabled)</i>

Figure 14. Video Module and sub modules

Gallery had been a major challenge in Drupal, haven tried out several ways from tutorials I have found but will always one or two issues with it, even with the all encompassing CCK and VIEWS modules which Drupal has got. However after so much research and tweaking of the codes it was fixed.

5.2 Intranet

There had been need to create an avenue where co-workers could share ideas, events, news, images, collaborate and discuss on issues or someone creating a blog to show workaround on a problem or project at hand. In achieving this and based on my research and haven tested several modules, the following contributed modules will be used:

Table 1. Intranet Modules

Modules	Functions
Forum:	This enables threaded discussions about general topics
Blog:	This makes all members within the organisation create and update their respective pages within the organisation; hence making them update their activities.
Polls:	This module makes it easy to determine the members or co-workers opinion on some issues at hand by creating votes which could be captured by the administrator. Here it should be noted that only the manager is allowed to create the poll.
Aggregator:	Just as indicated earlier, this will be used to pull content from other interested online resources to the organisation

After this was implemented, all registered members by the administrator were able to have their contents on the page, participate in votes and also share ideas among themselves within the forum.

Figure 15, 16 and 17 are from the intranet system.

HOME FORUMS INFO BLOGS POLLS CREATE CONTENT NEWS&EVENTS MY ACCOUNT

Mission:
To Produce a Professional CMS System capable of several functionalities for Enterprise Users.
While also promoting the open source community and treasuring its integrity.

12 RECENT BLOG POSTS

- » OpenVPN How To
- » Build ur web shop
- » Usb Applications
- » Routing Protocols

[more](#)

NEW FORUM TOPICS

- » How
- » Drupal CMS

[more](#)

RECENT COMMENTS

HOME
Posted Wed, 07/08/2009 - 12:49 by ubuntu

Open Kvarken will establish a permanent Centre of Competence in Open Source in our cross border region, called Kvarken: Vaasa and Umeå. Open Source is **not a zero-sum game** like in Fairy Tales but grows when sharing

[Read more](#)

RECENT PROJECTS
Posted Wed, 07/08/2009 - 14:15 by ubuntu

Moodle development
We will develop Moodle for use in lower education, classes 7-9 and 10-12.

School tool
School tool will release version 1.0 this autumn and it is an affordable administrative program for schools

Ekiga and DimDim
We are developing two different web meeting products, Ekiga and DimDim for the SIP protocol and with tunneling capabilities.

Figure 15. Intranet Home with recent blog post and recent comments

Forums

Login to post new content in forum.

Forum	Topics	Posts	Last post
Enterprise			
Linux Based Enterprise solutions			
✉ RedHat	0	0	n/a
OpenSource			
Open Community to all			
✉ CMS solutions	0	0	n/a
✉ Drupal	1	1	45 weeks 1 day ago by ubuntu
✉ e107	0	0	n/a
✉ Voip solutions	0	0	n/a
✉ ekiga	0	0	n/a
✉ OpenMeetings	0	0	n/a

Figure 16. Forum page with their respective discussion topics



Figure 17. Polls to vote and recent blog posts



Figure 18. How individual Poll looks like

Figure 16 shows the entire forum topics as relevant within the organisation, which is being set by the administrator, this will make all individuals within the organisation make relevant contributions to issues relating to respective discussions, and in the long run it will aid the resolution of problems if any as fast as possible due to the collaborative tool being implemented. In figure 17, recent blog and polls which had been created are displayed, it shows several blogs of how some stuffs had been made which will serve as a guideline to others to follow. Finally figure 18 shows how an individual poll looks like from the collection of polls from figure 17, as displays it allows users to choose what they think of the issue at hand. This will help in making a logical conclusion based on the majority vote.

5.3 Web Booking

There are times when the need to make a web application that allows for clients to make reservations becomes inevitable probably that is the sole source of income of such organisation or individual, hence it becomes important to know if Drupal

is capable of providing such a system which is robust, scalable, flexible, easy to set up and maintain.

In setting up a web booking system, the main focus is to have a means to manage all forms of item reservations ranging from events, items, and accommodations, likewise manage the payments in a secure way. At this juncture it should be noted that there seems not to be many modules available for bookings system in Drupal except with custom development.

Open Resort is a module highly recommended based on discussions from the Drupal forum (<http://groups.drupal.org/booking-systems>), it is meant to be the main Drupal booking engine, however it is not supported by Drupal 6 which makes it not suitable. Furthermore, the Open Resort project has been last updated since 2008 unlike other modules which are constantly updated to meet up with contemporary challenges of users.

Another module was later checked out, the Simple Reservation v1.2 which uses the date module as a pre-requisite. This module works fine in making items set for reservations which will be set by the administrator. Below are the administrator's view and the user's view of the module.

Simple Reservation					
Name	Description	Comment	Status	Operations	
Boat	Enjoy your summer with out state of the art boat	A comment	available	edit	delete
Carrier Truck	Size ...Big	A comment	available	edit	delete
Halli	State of the Equipment with all computerized systems to control	Wireless Facility available for audience	available	edit	delete
Room1	An internet based apartment with own bath and toilet	No smoking in the aprtment	available	edit	delete
Room2	Would you like to cook as well, then it is available + internet + microwave	No smoking in the aprtment	available	edit	delete

[Create new item](#)
[Show all reservations](#)
[Show all upcoming reservations](#)

Figure 19. Simple Reservation Admin View

Figure 19 shows various items which had been created for reservations for users to book, from the figure it shows that there is a boat, carrier truck, halli and rooms available for reservation. More items could be easily added, reserved items could be displayed likewise upcoming reservations are made available on request. All of

these are only visible to the administrator or any other user which had been given the access right to access this configuration part of the simple reservation module.

Reservation	
← previous week	← previous month
April 2010, week 17	
next month →	next week →
Sunday, 18.04.2010	+
Monday, 19.04.2010	+
Tuesday, 20.04.2010	+
Wednesday, 21.04.2010	+
Thursday, 22.04.2010	+
Friday, 23.04.2010	+
Saturday, 24.04.2010	+

Figure 20. Simple Reservation User's View

Making the reservation becomes possible after the configuration of the simple reservation module by the administrator, figure 20 shows the reservation interface and how it is being done. Because the reservation works with the date module as said earlier, the date pops up once the **+** sign is clicked during which the reservation is about to be made.

The above module works fine, however I noticed the module hasn't been integrated with the taxonomy module which allows for classification and logical grouping in Drupal. But because having a system that will enable me group similar items into same group instead of having all items in one place is more preferable, Simple Reservation v1.2 seems not be a perfect solution.

Based on the task at hand, the Check front module was found to be suitable for this purpose. It should be noted that check front is an independent reservation system which has a module to allow a Drupal Site has access to the administrator's check front reservation account (<http://drupal.org/project/checkfront>). It provides the logical grouping of similar items and easy reservation system.

Check front creates an automatic SSL connection with https and a custom URL to the reservation page. This assures security; however, the administrator is subject

to the terms of check front and details could be found here (<http://www.checkfront.com/legal/terms>). I faced difficulty in making check front accessible on my Drupal page after making necessary setup at <https://openwebshop.checkfront.com>.

Another module being checked was Planyo, It is a commercial module which allows for Drupal integration. However, there are limited functions available for the free version being integrated with Drupal. This includes not being able to create more than one category of item to allow for reservation. The images seen afterwards are the screen shots from the planyobooking reservation module. All of the items, in this case apartment available for reservation are displayed in figure 21, various houses with different specification could easily be selected from the display and as shown in figure 22, Casa Sono had been selected.

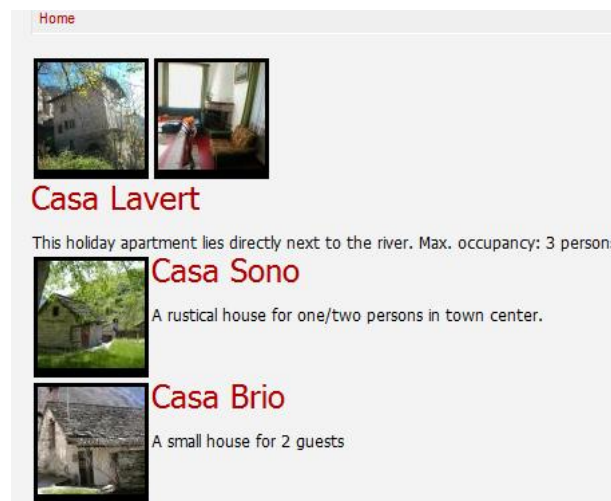



Figure 21. Planyobooking Reservation

Home

Casa Sono

A rustical house for one/two persons in town center.

[Make reservation](#)



«previous next»

May 2010							June 2010							July 2010						
M	T	W	T	F	S	S	M	T	W	T	F	S	S	M	T	W	T	F	S	S
x	x	x	x	x	x	x	x	x	x	x	x	x	x	28	x	30	x	x	x	4
x	x	x	x	x	x	x	x	x	x	x	x	x	x	5	6	7	8	9	x	11
x	x	x	x	x	x	x	x	x	x	x	x	x	x	12	13	x	15	16	x	x
x	x	x	x	x	x	x	x	x	x	x	25	26	27	x	x	x	x	x	x	x
x	x	x	x	x	x	x	28	x	30	x	x	x	4	x	x	x	x	x	x	31
x	x	x	x	x	x	x	5	6	7	8	9	x	11							

31 Available x Unavailable

Figure 22. Casa Brio Selected

Once a reservation is made, there is need to have a contact information of the user with the reservation being made for easier management. Just as it is shown in figure 23, the contact details of the user is being stored in the database, this will ensure reminding the reserve one the reserved day approaches.

RESERVATION DETAILS

Apartment Casa Sono

Arrival date*

Departure date*

Reminder

Your rate
CHF 70.00

PERSONAL DETAILS

First name*

Last name*

Address

City

ZIP/Postal code

State/Province

Country

CONTACT INFO

Email address*

Mobile*

Figure 23. User Li Di making reservation

Reservation ID	Apartment	User	Duration	Status	Created
R11013	Casa Lavert	kkkk hhgggh	2010/05/20 - 2010/05/30	Reserved	2010/04/23 13:49
R11281	Casa Brio	German Mogliani	2010/05/21 - 2010/05/23	Email address verified	2010/05/04 12:23
R11467	Casa Sono	li di	2010/05/21 - 2010/05/22	Reserved	2010/05/04 13:05

Figure 24. Admin View of the reservations

Figure 25 shows some of the reservations being made in the system and especially, it could be seen that user Li Di has made a reservation of the Casa Sono apartment.

So far, based on my research into the Drupal modules, Drupal seems not be so be fully functional when it comes to making reservations. Majority of the developed modules are either not supported in Drupal 6 or have become abandoned projects. Even the Bookings API which is available is a developmental version and had been updated since March 31, 2008 (<http://drupal.org/node/240864/release>).

5.4 Web Shop

This is meant to allow VCOSS set up an online web shop from within the content management framework. Before now they have been used to making an independent web shop which will have its own separate expenses. But now, if Drupal could be a suitable framework to allow achieve this from within same content management system, then it will be a suitable platform. In achieving the web shop, the following modules had been installed:

CCK Content Construction Kit

Image Cache with other embedded ImageAPIs

Thickbox

getID3()

Token, Token actions and TokenSTARTER

Google Analytics for Statistics

Views

Ubercart and all of its default core Modules.

A catalogue of products was designed which includes Servers, Management Systems and Desktop Applications. Each of these catalogues has its own individual products as described below:

Table 2. WebShop Catalogue and Products

Catalogue	Table
Desktop Applications	PortableApps
Servers	Enterprise Serveri Medium Serveri Small Serveri
Management Systems	Content Management Systems -----easyWeb

	<p>-----web Publisher</p> <p>Learning Management Systems</p> <p>-----easy Learning</p>
--	--

Based on above table, the shop was implemented thus with the whole catalog displayed on the first page, figure 26 shows this better.



Figure 25. Catalog Menu with all other classification

Once the product had been chosen a shopping cart is easily created which will make a customer easily manage its cart, either by deleting or adding more products to it. Once this is done then checkout is possible, however this is possible for only authenticated users (that is users which are registered to the web shop). Because the web shop will have users' information with their account data, it is of utmost concern to have customers make payments via a secured interface say using the SSL with https. In order to achieve this, PayPal being known for its integrity, had been integrated with the project, this will take care of the payment which is as a result of its reputation and integrity in keeping customers bank information.

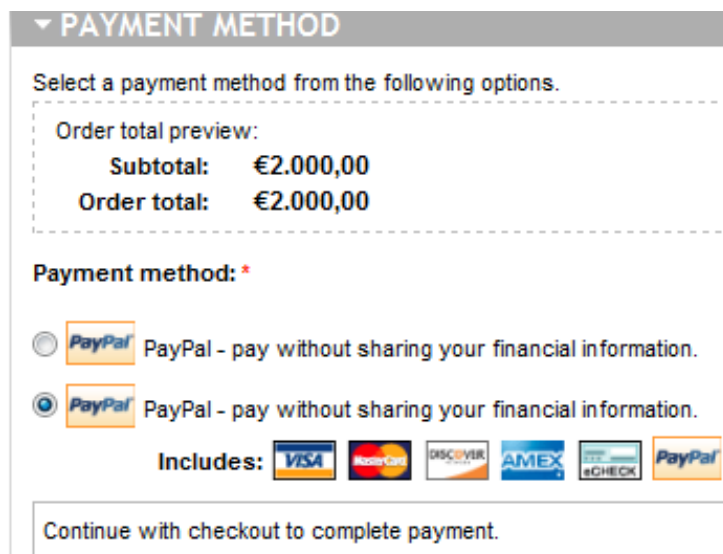

▼ PAYMENT METHOD

Select a payment method from the following options.

Order total preview:







Subtotal: €2.000,00

Order total: €2.000,00

Payment method: *

PayPal - pay without sharing your financial information.

PayPal - pay without sharing your financial information.

Includes:      

Continue with checkout to complete payment.

Figure 26 Payment method accepted

However, there are some limitations some of which were subject to my server, the first was not making the product image display with the image light box. So was forced to use the standard HTML image tag `` to make the image display. This am sure wouldn't be experienced on the OpenKvarken portal because they've got a better server configuration than mine.

The second was having a secured web shop, due to difficulties encountered, all product navigation have been made on normal http (port 80) and all other customer account details being handled by PayPal which had been known for its integrity in data security.

6 CONCLUSION

There are bounds to be problems in projects like this especially when one had to figure out how a particular modular system works. Getting to use the system was very challenging at inception because we were entirely new to the framework, Drupal. At start Drupal was frustrating due to the lack of the graphic user interface as compared to other open source frame works earlier worked with. So had to figure it out myself by reading on several documentations but can you imagine the funny thing about is? Once you get it, then you are on the move and the complexity is simplified.

Drupal was found to be very useful, but there seems to be some projects which would have been a major backbone in implementation of some applications had been abandoned, not updated or even compatible with the latest Drupal 6. An example of this was the OpenResort module which was described to be the main booking engine of Drupal, this module was found not to be compatible with Drupal 6 and had since been updated in 2008. Drupal doesn't only suffer this, it is a common issue with Open Source projects.

Based on this, could Drupal still be qualified as a Content Management System with the criteria set forth earlier from the beginning of the project?

In terms of scalability, Drupal allows for future growth and it is capable of accommodating lots of content with various presentation styles be it in form of the mobile, video and audio. Publishing flexibility is another important thing, Drupal can confidently handle how the contents are published with adequate workflow and easy change of look at any time, and this will keep the site more dynamic at every point. So far, the best is to ensure that the CMS to be implemented is capable of meeting up with requirements of the organisation, Drupal hasn't failed in this. (Selecting a CMS, how to narrow down a chasm of choices, 16 March 2010 EzineArticles available from < www.ezinearticles.com>).

After so much research in to the Drupal frame work which commenced from my internship at VCOSS during the 2009 summer, we have come to realise that Drupal is capable of being used in various scenarios as this study has shown. Web Portal, Web Shop, Intranet, Web booking, Education, Resource directories, art, music and multimedia, these and many more are the scenarios it had been implemented. If a site is intended to retail a large number of goods, it will be nice to consider open source frame works purposely meant for things like that say osCommerce (David Mercer, 2006, Configure and customize Open Source CMS). However, Drupal too is capable of such with contributed modules as done in this thesis.

With regards to our assessments, Drupal suits well to the implemented scenarios, however Drupal could be limited in its own functionalities as well. There seems

not to be much available modules when it comes to making reservation systems (web booking).

Based on this study and its familiarity, VCOSS had finally implemented Drupal for the OpenKvarken project (www.openkvarken.fi) and there had been various reputable organisations using Drupal this includes, Yahoo, Nokia, World Bank (Intranet), MTV, AOL, FedEx, Nokia, Source Forge, Sun Systems, Belgian Government, French Ministry, Second Life community, British council, Harvard University and many more. An interesting thing here is that the entire Drupal Project is an Open Source project, hence there isn't much involved in getting the licence. This makes various organisations embrace it.

7 LIST OF REFERENCE

- [1] High Profile Websites Powered by Drupal, Agnian, Available in <http://www.slideshare.net/agnian/high-profile-websites-powered-by-drupal>
- [2] Open Source Definition, Open Source Initiative. Available from <www.opensource.org/docs/osd>
- [3] Navigating Content Management, 2008. Karen. A. Coombs University of Houston, Texas.
- [4] Journal of the European Association for Health Information and Libraries 2008, Vol. 4 (3) Drop in: Drupal for Libraries, Patrice Chalon, Belgian Health Care Knowledge Centre (KCE)
- [5] Drupal Available from < www.drupal.org/project/drupal>
- [6]. David Mercer, 2006 Configure and customize Open Source CMS.
- [7] David Mercer, 2008. Building powerful and robust websites with Drupal 6
- [8]. Selecting a CMS, how to narrow down a chasm of choices, 16 March 2010 EzineArticles available from < www.ezinearticles.com>