

Development of fiber lasers

Yang Zhang and Guoqing Huang
Bachelor's Thesis

Abstract

Field of Study Technology, Communication and Transport			
Degree Programme Degree Programme in Industrial Management			
Author(s) Yang Zhang and Guoqing Huang			
Title of Thesis Development of Fiber Laser			
Date	08.04.2013	Pages/Appendices	55
Supervisor(s) Heikki Salkinoja, Seppo Ryyänen			
Client Organisation/Partners			
Abstract <p>In recent years, fiber lasers have been focused as research topic in the field of laser. It is widely applicable in the field of modern optical communication, optical sensing, materials technology, life sciences and precision mechanics, national defence science ,etc.</p> <p>Fiber laser is typical representative of the third generation lasers. Fiber lasers have great advantages compare to any other lasers, such as long lifetime, small size, high efficiency, compact structure, etc.</p> <p>This report begins by introducing the basic knowledge of lasers. Then the overview the is given on operating principle and research status of fiber laser, some typical fiber lasers. In the end the application and future prospects of fiber lasers are introduced.</p>			
Keywords Fiber laser, laser, DCFL, welding application			

CONTENT

1 Introduction	8
2 Laser introduction	9
2.1 The generation theory of laser	9
2.2 The characteristic of laser	10
2.3 The application of laser	11
2.4 The hazard classification and safety of laser	14
3 The development and status of fiber laser	16
3.1 The development of fiber laser	16
3.2 The status of fiber laser	18
4 The basic principle of fiber laser	20
4.1 The atom foundations	20
4.2 The core principle of atoms forming the laser	21
4.3 The basic structure and principle of fiber laser	24
5 Introduction of typical fiber lasers	26
5.1 The classification of fiber laser	26
5.2 High power fiber laser	26
5.3 Double-clad fiber laser (DCFL)	27
5.4 Mode-locked fiber laser.....	31
5.5 Q-switch fiber laser.....	33
5.6 Raman fiber laser (RFL)	34
5.7 Photonic crystal fiber laser (PCFL)	35
5.8 Narrow line-width fiber laser	36
5.9 Multi-wavelength fiber laser	37
6 The applications of the fiber laser	39
6.1 The application value of fiber laser	39
6.2 The applications of different power fiber laser	40
6.3 The applications of different fields	43
6.3.1 Industrial applications	43
6.3.2 Military applications	46
6.3.3 Biomedical engineering	47
6.3.4 Communication applications	48
7 Development prospects of fiber laser	49
8 Conclusion	51
References	52

SYMBOLS AND ABBREVIATIONS

AOM	acoustic optical modulator
CW	continuous wave
CWL	continuous wave laser
DCFL	double clad fiber laser
DBR	distributed Bragg reflector
DFB	distributed feedback laser
DWDM	dense wavelength division multiplexing
EDF	erbium doped fiber
EDFA	erbium doped optical fiber amplifier
F-P	Fabry P�erot
GOF	glass optical fiber
ISR	intelligence, surveillance, reconnaissance
LD	laser designator
ns	nanosecond
OTDM	optical time division multiplex
PC	polarization controller
PCFL	photonic crystal fiber laser
PLC	programmable logic controller
RF	radio frequency
RFL	Raman fiber laser
RHML	rational harmonic mode locking
SBR	saturable prague reflector
SBS	stimulated Brillouin scattering
SESAM	semiconductor saturable absorber mirror
SOA	semiconductor optical amplifier
SVR	surface area to volume ratio
Tb	terabits
TIALD	thermal-imaging airborne laser designator
WDM	wavelength division multiplexer
Yb	ytterbium
ZDP	zero dispersion point

1 Introduction

Fiber laser is the laser that uses the rare earth-doped glass fiber as the gain medium, fiber lasers are based on the optical fiber amplifier: after the function of pump light the fiber gets a high power density, it forms the laser oscillation outputs.

The research of fiber laser was started in the 1960s, The American Optical Company's scientists proposed the concept of fiber laser.(weiku) The performance of fiber laser depends on the fiber-optic system, so in recent research it is focused on photonic crystal fiber laser, double-clad fiber laser, mode-locked fiber laser and so on. However, the scientists follow the trend to develop the high-power fiber lasers, because if the other parameters are retained, the bigger power energy density is, the faster processing speed the fiber laser has. Imaging that if high-power fiber lasers are widely used in the actual production, it is sure that it will bring a huge improvement of production efficiency and production quality.

Fiber lasers are widely applied in many areas, including laser fiber-optic communications, laser space telematics, laser machining, military and medical usage, usage as other laser pump source, etc.

This article is written by Zhang Yang and Huang Guoqing, Zhang Yang is responsible for writing chapters 1, 2, 5 and 8; Huang Guoqing is responsible for writing chapters 3, 4, 6 and 7.

2 Laser introduction

To study the fiber laser better, the knowledge of laser should be introduced first. This chapter will introduce some basic studies of the laser, like the basic theory of laser and the safety of laser.

2.1 The generation theory of laser

The laser is generated by the interaction between light and matter. In fact, the microscopic particle radiates or absorbs the photon, and at the same time changes its self-motion condition. The figure 2.1 is indicating the regular of interaction between photon and light.

The photons have their own energy level. Photons only appear in the position of corresponding energy level in any time. When interacting with photon, it will jump from one energy level to another, so do radiation and absorb photon at the same time. The energy difference is ΔE , the frequency formula is:

$$\nu = \Delta E/h \quad (1)$$

ν = the value of frequency

ΔE = energy difference

h = Planck constant

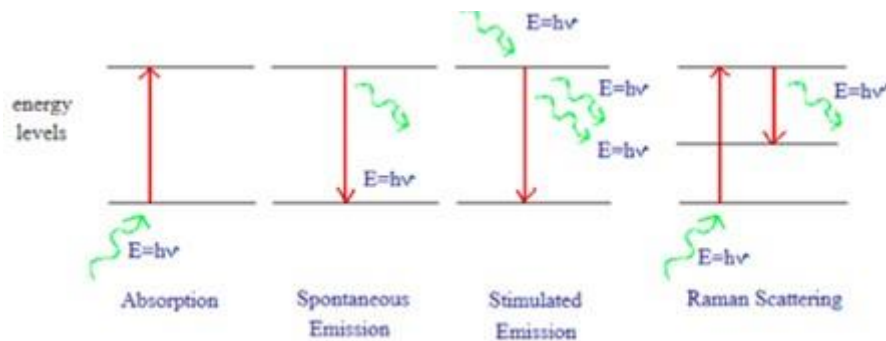

Figure 2.1 Interaction between photon and light (St Andrews)

Stimulated absorption

The photon in lower energy level will absorb the energy before jumping to a higher energy level when it simulated by the external space.

Spontaneous emission

The photons transform to excited state by simulate. This is an unstable status. It will jump from high energy level to low energy level spontaneously, and emit a photon at the same time. This radiation process is called spontaneous radiation. The light emission by radiation will disaccord with the phase, polarization state and direction of propagation. This is the non-coherent light.

Stimulated emission

In addition to the spontaneous emission, microscopic in a high energy level (E2) can transform to a lower energy level (E1) in another way. When the photon incident by the frequency of ν . It will lead the microscopic transform from energy level of E2 transition to energy level of E1 in a certain probability. Radiation photon that the frequency, phase, polarization state and the direction of propagation same with the external photon at the same time, this process is called stimulated emission.

If there are a large number of atoms in a higher energy level (E2) and there are photons with the frequency of ν incident will simulate the atoms in the energy level of E2 and obtain two same characteristic photon, this two-photon will simulate the atoms in the energy level of E2 again, and obtained four same characteristics photon. This means that the original light signal is amplified. This stimulated process and produce the amplified light is called the laser. The figure 2.2 below is the laser in the daily life.



Figure 2.2 Laser (Guoqing Huang)

2.2 The characteristic of laser

Ordinary light source is radiating light to all directions. If you want it go to one direction, you need to install an optical block for the ordinary light, such as a cap-lamp and car head light (as the figure 2.3 shows). But the laser device emits to one direction. The degree of divergence of the light beam is extremely small, nearly parallel. The light illuminate from laser lamps is very straight. But the diameter of the light illuminated from a flashlight is bigger and bigger from near to far.



Figure 2.3 Head light of a car (Guoqing Huang)

The luminance of the laser is very high. In ordinary light the xenon has a very high luminance already. But the luminance of the laser is dozens billion times of xenon.

The colour of laser depends on the wavelength of the laser. The wavelength is decided by active material of the laser emission. For example, argon gas can produce a blue-green laser beam. The ruby can produce deep rose-coloured laser beam. Semiconductor laser emits infrared light.

The colour of the light is determined by the wavelength of the light, the wavelength corresponding to a certain colour. The wavelength of the light output by laser is very narrow and therefore the colour is extremely pure.

Formula (1) shows searched that the higher the frequency, the higher the energy is. It can be seen that the laser energy is not very big, but its energy density is very big, because its actuating range is very small, and it brings a huge energy in a short time, so the laser can be used as a weapon.

The high coherence of the laser: mainly describes the phase relationship between the various parts of the light waves. This feature has been widely used in industrial processing.

2.3 The application of laser

Laser indication

The most common is the TIALD, also known as a laser pointer. The laser pointer (as Figure 2.4 shows) uses the visible laser to design as a portable pen-type emitter. Common laser pointers have red light type (650-660 nm), green light type (532 nm) and blue-violet light type (405 nm). Usually it is used as a point guide, and is convenient for teachers and guides.



Figure 2.4 Laser pointer (Pengcheng)

Process technology

Interaction between the laser beam and the matter is used to cutting, welding, surface treatment, drilling and micro-machining the material. Laser technology refers to optical, mechanical, electrical, materials, testing and many other subjects. It generally can be divided into: processing system including the laser, light guide systems, processing engine bed, control system and the detection system.

Processing techniques

Processing techniques include cutting, welding, surface treatment, drilling, marking, scribing, trimming and other processes.

Laser welding can be used in welding of device that does not allow the welding contamination and deformation. Like the lithium batteries, cardiac pacemakers, sealed relays and sealing devices.

Laser cutting is widely used in the automotive industry, computers, electrical cabinet, various metal parts and special materials. Cutting circular saw blade, acrylic, spring washers, wire mesh panels, steel pipes, phosphor bronze, wood, thin aluminium alloy, quartz glass, silicone rubber, alumina ceramic pieces, titanium alloys used in the aerospace industry and so on. Figure 2.5 is a new type laser cutting machine.

Laser marking is widely used in a variety of materials and almost all industries.

Laser drilling main applications are metal and other industries.

Laser heat treatment is widely used in the automotive industry. Also it is widely used in the aerospace, machine tool industry, and other machinery industry.

Laser cladding technic is widely used in the aerospace, mold, electrical and mechanical industry.



Figure 2.5 Laser cutting machine (Binqi)

Laser rapid prototyping technique combines the laser processing technology, computer numerical control technology and flexible manufacturing technologies, and is used for the mold and model industry.

In medical field

Laser can play such roles as the drill, scalpel, welding torch in the field of medical equipment. Laser torch and drill in the ophthalmology is used to treat retinal detachment, In dentistry, the laser can replace the dental drill.

Laser weapons

The laser weapon has the advantages of being fast, flexible, accurate and anti-electromagnetic when compare to the common weapons, can play a unique role in the air defence and strategic defence. Laser weapons include laser radar (as Figure 2.6 shows), laser sight, laser missiles and laser guns.



Figure 2.6 Laser radar (Nikon)

2.4 The hazard classification and safety of laser

The classification of laser

The hazard classification of laser product is based on the degree of impact on human health. It is classified from Class I laser (no damage) to Class IV laser.

Class I: The laser products do not have the biological hazards. The laser system must be interlocked when the laser is exposed.

Class II: the laser product will neither damage the skin nor cause the fire. However, it can cause certain eye damage. So this type of laser product is not considered as dangerous optical equipment.

Class III a: This type of laser products will not damage the skin. However, in a certain condition, this type of laser can cause blindness and other damage to the eyes.

This type of laser products should take these measures:

- 1) Laser emitting light to indicate that the laser is working.
- 2) Should use the key switch to prevent unauthorized people to use.
- 3) A danger label should be attached to notice the people.

Class III b: This type of laser products will damage the skin. This type of laser products are clearly defined harmful to the eyes, especially when the power is very high, it will cause eye damage.

These laser products must have:

- 1) Key switch to prevent unauthorized people to use.
- 2) Laser emitting light to indicate that the laser product is working.

- 3) A 3-5 seconds delay time when the power is turned on to allow the operator to leave the beam path.
- 4) An emergency stop switch so that at any time the laser beam can be switch off.
- 5) A red hazard labels must be attached to laser products.

Class IV: This type of laser products will have a serious damage to the eyes. The laser is able to ignite other materials. These laser systems must have:

- 1) Key switch to prevent unauthorized people to use.
- 2) Laser emitting light to indicate that the laser product is working.
- 3) An emergency stop switch so that at any time the laser beam can be switched off.
- 4) A red hazard labels must be attached to laser products.
- 5) A safety device to prevent the protection cover be opened by anyone.

The harm caused by the laser for eyes, nerves and skin

If the laser intensity is not very high, it may cause diminution of vision. If the laser intensity is very high, it may lead to blindness. The eye injury caused by the laser is related to laser wavelength, pulse width, environment and so on.

The laser effect on nerve: The impact of the laser on the nervous system is caused by disturb. Lasers go through the skin and force on the nerve endings.

The skin damage: high laser density may cause the skin erythema, ageing and even cancer.

The protection of laser hazard

In order to ensure the safety and protection of the laser products, laser hazards must be strictly controlled.

Personal protection:

Wear laser safety glasses (as Figure 2.7 shows).

Wear the Laser protective masks: laser protective masks not only protect your eyes, but also help you to protect the facial skin.

Wear the laser protective clothing and gloves: protective clothing should be fire-resistant and heat-resistant.



Figure 2.7 Laser protective glasses (Standa)

3 The development and status of fiber laser

3.1 The development of fiber laser

In early phase, the research of lasers was mainly concentrated in the expanding aspects of short pulse outputting and the range of tunable wavelength. At present, DWDM (Dense Wavelength Division Multiplexing) and OTDM (optical time division multiplexing) technology are rapidly developing and progressive day by day to stimulate the progress of the multi-wavelength fiber laser and super continuum fiber laser correlation technology. And then the emergence of multi-wavelength fiber lasers and super continuum fiber laser provide the ideal solution to achieve with low-cost the Tb / s (1 Terabits / s = 1012 bits / s) transmission of DWDM or OTDM. From the perspective of the technical approach of its achievement, it uses EDFA (Erbium-doped Optical Fiber Amplifier) amplified spontaneous radiation technology, femtosecond pulse technology and super luminescent diode technology. (Wiki.dzsc)

At present, in the international field the research direction and hot spots of fiber laser are mainly concentrated in high-power fiber lasers, high power photonic crystal fiber lasers, narrow line width tunable fiber lasers, and multi-wavelength fiber lasers, nonlinear effect fiber lasers and ultra-short pulse fiber laser and their differences.

It has been more than 50 years since the advent of the first GaAs semiconductor laser in the world. The semiconductor laser has been widely used in the field of laser communications, optical disk storage, and laser detection. With the increasing of continuous output power of the semiconductor laser, its scope of application is also expanded and DPSSL (Diode Pump Solid State Laser) is the largest one of application areas. The semiconductor laser is small in size, light in weight and direct electron injection with high quantum efficiency. The different wavelengths can be obtained by adjusting the component, and controlling the temperature to match with the absorption wavelength of the solid-state laser material. But its beam quality is poorer, the asymmetry of two directions and the transverse mode is also not ideal. The outputting beam quality of solid-state laser is higher and high coherence in time and space, spectral line width and beam divergence angle is smaller orders of magnitude than the semiconductor laser. For DPSSL, it absorb the high-energy photons of short wavelength, and translate into the low-energy photons of longer wavelength, so there is always part of energy converting to heat by the way of the non-radioactive transition. How could this part of thermal energy be emitted from the laser medium and get rid of key technologies to turn into diode pump solid state lasers. Therefore, the people began to explore methods to increase the cooling area.

One approach is that the laser medium is made into an elongated fiber shape.

So-called fiber laser is using an optical fiber as a laser medium. In 1964, the first glass laser is fiber laser. It mixed activated neodymium ions (Nd^{3+}) into the glass matrix. As the core of the optical fiber is very fine, the pumping source (such as a gas discharge lamp) is difficult to focus to the core portion. So in next more than twenty years the fiber laser is not well developed. With the development of diode-pumped laser technology and the need of optical fiber communication booming, the experiments of University of Southampton in the United Kingdom in 1987 and in the United States Bell Labs show the feasibility of the erbium-doped (Er^{3+}) fiber amplifier (EDFA). It uses the erbium-doped single-mode fiber to implement amplification of optical signal, and now this EDFA has become an important and indispensable device in optical fiber communication. As the semiconductor laser is pumped into the core of the single-mode fiber (generally less than 10 μm in diameter), so require that the semiconductor laser must also be single-mode. This makes single-mode EDFA

difficult to achieve high power, and as we know that the highest power are just a few hundred milliwatts. (Wiki.dzsc)

In order to improve the power, around 1988, it was suggested that optical pumps entrance from the cladding. The initial design is a circular inner cladding, but because of the perfect symmetry of the circular inner cladding, so that the absorption efficiency of the pump is not high, and until the early nineties the rectangular inner cladding appears, made the laser conversion efficiency up to 50%, and the output power reach to 5 watts. Using four 45-watt semiconductor lasers to pump from both ends of the pump, and achieve the output of 110-watt single-mode cw-laser. In the past two years, with the development of high-power diode-pumped technology and double-cladding fiber production process, the output power of fiber laser gradually increased, and has achieved 1000-watt laser output by the use of a single optical fiber.

Compared with the international development, the development of Chinese fiber laser is also not falling behind:

In 2002, Nankai University achieved pulse width 8 ns self-Q-pulse output in ytterbium-doped (Yb^{3+}) double-clad fiber and peak power greater than 8 kW, pulse width of less than 2 ns pulse output in hybrid Q-switched double-clad fiber laser. (Marine technology p.32)

In 2003, Nankai University used pulse-pump to achieve Q-switched pulse of 100 kW peak power, and the 60 nm tunable Q-switched pulse. (Marine technology p.32)

In 2004, Tsinghua University achieved cw-pump with 206 kW peak power Q-switched pulses. (Marine technology p.32)

In 2005, Institute of optics and electronics of Xi'an achieved 98 W continuous output of PCFL (Photonic Crystal Fiber Laser). (Marine technology p.32)

In 2013, myriawatt cw-fiber laser was coming out in optical valley of China. China became the second country of mastering this technology after the United States, and the myriawatt fiber laser made by United States can be seen in the following figure 3.1. Its whole situation is that this laser is similar with the size of two freezers. And there are energy cube of 10 pieces in the laser, and each is 1100 watts. (Marine technology p.32)



Figure 3.1 10,000 Watt Single Mode Laser (Opticsjournal)

Recently, the research has been increasing attention in different applications area with a wide range of application and development of optical fiber communication systems: ultra-fast optoelectronics, nonlinear optics, optical sensing and other areas.

3.2 The status of fiber laser

At present, there are about 15 companies producing industrial fiber laser in China. Most of them were created since 2010 by the overseas students. More than half of them have the background of top institutes. And this just shows the attractiveness of the fiber laser technology and applications market on the capital market and the talent market. However, due to the returnees own individual business model, they only brought back one or several technologies and processes, and cannot do it alone in the entire fiber laser manufacturing industry. Therefore almost all companies in the early days depended on imports of key parts, and some were beginning from assembling components of import, to occupy the application market firstly. As the market expands, some companies began the second phase of the investment, and researched and produced key components and patent, and gradually formed industry chain of key components in the country. Such as optical fiber coupler, pattern-applier, acousto-optic modulator, opto-isolator, etc. In generally the average power of laser is below 100 W. It is called as a low-power laser, if it is more than 1 kW, it is called as high-power laser.

The earliest breakthrough in fiber laser field in China is the laser marking market. After returning from the United States, Dr. Yan Dapeng created Ruike Company in Wuhan city in 2007, and in

2008 launched the low-power fiber laser into market. The 4 kW products shown in the figure 3.2 have launched into the market in 2013. (Dr. Gubo)



Figure 3.2 Multimode cw-fiber laser 1 to 4 kW Ruike (Dr. Gubo)

Among several famous fiber laser companies, one is Guoshen Electro-Optical Technology company, It was created by Dr.Guo, returning from Europe. The high and new tech enterprises cooperated with Shanghai Institute of Optics and Fine Mechanics closely and specialized in the picosecond and femtosecond laser. The femtosecond laser is shown in figure 3.3. The company has a large number of patented technologies. (Dr. Gubo)



Figure 3.3 Femtosecond fiber laser Guoshen (Dr. Gubo)

4 The basic principle of fiber laser

The fiber amplifier doping the rare earth elements promotes the development of fiber lasers, because optical fiber amplifier can form fiber laser through appropriate feedback mechanism. When the pump light is through the rare earth ions in the fiber, it will be absorbed by the rare earth ions. At this time in the rare earth atoms absorbing photon energy, the electrons will be excited to jump to higher energy state and achieve population inversion. After inversion, the particle population will be transferred from a higher-level to the ground state through radiation, and release energy to complete stimulated radiation. The stimulated radiation is the radiation with same frequency and the same phase; it can form a laser with a good coherence.

4.1 The atom foundations

Atoms have perpetual motion. They keep vibration, move and rotate, and even the atoms constituting our seats are constantly moving. Solid is moving, in fact. There are several different excited states for atoms. In other words, they have different energies. If an atom gets enough energy, it can rise from the ground-state energy level to the excited state energy level. The low or high of the excited state energy level depends on the energy of atom given by heat energy, light energy, electric energy and other forms. (*Elec & Micro technology*)

A simple atom consists of nucleus (containing protons and neutrons) and electron cloud. The electrons in the electron cloud move along multiple different orbits around the nucleus. The following figure 4.1 explains the structure of the atom:

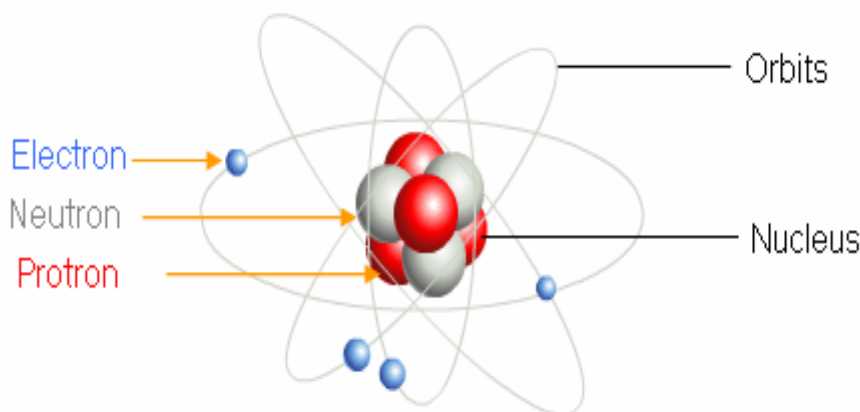

Figure 4.1 the structure of the atom (Elec & Micro technology)

Electrons revolve around the nucleus in different energy levels or shells and each shell is associated with definite energy. The energy of the K shell is the least while those of L, M, N and O shells increases progressively. Any system that has least energy is the most stable. I energy level is K shell, II energy level is L shell, III energy level is M shell, IV energy level is N shell and so on. Maximum numbers of electrons in I energy level are 2, maximum numbers of electrons in the II energy level are 8 and so on. This is shown in Figure 4.2. (*Tutor Vista*)

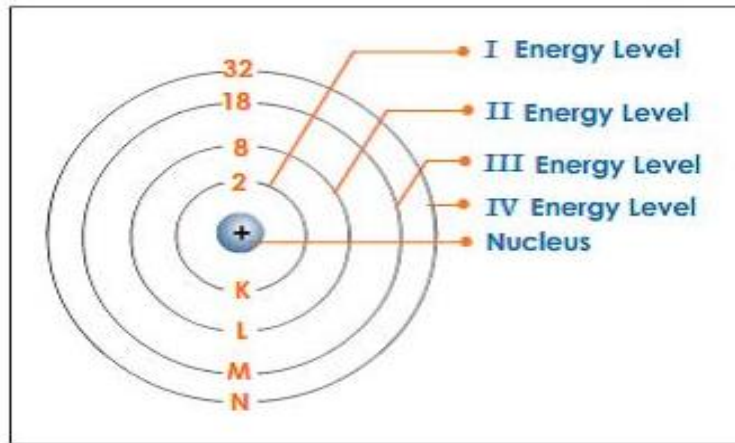

Figure 4.2 The structure of an atom concept (Tutor Vista)

4.2 The core principle of atoms forming the laser

The discrete track of electron cannot be seen, but these tracks are conceived as the different energy level of atom and will be helpful to our understanding. In other words, if heating the atoms, the part of the electrons in a low-energy orbit may be excited and jump into a high-energy orbit being farther from the nucleus. It is shown in Figure 4.3.

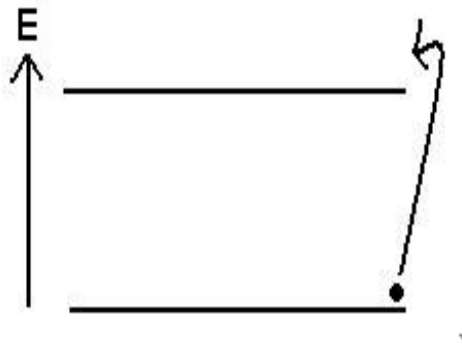

Figure 4.3 Electron jump from a low-energy orbit to a high-energy orbit (Guoqing Huang)

Electrons jump to a higher orbit, and then it will still be back to the ground state. In this process, electrons will release energy in the form of a photon (light particle). Atoms constantly release energy in the form of photons. It is shown in Figure 4.4. For example, a heating element in the oven turns into the bright red color, wherein the red is photon released by excited atom according to heating.

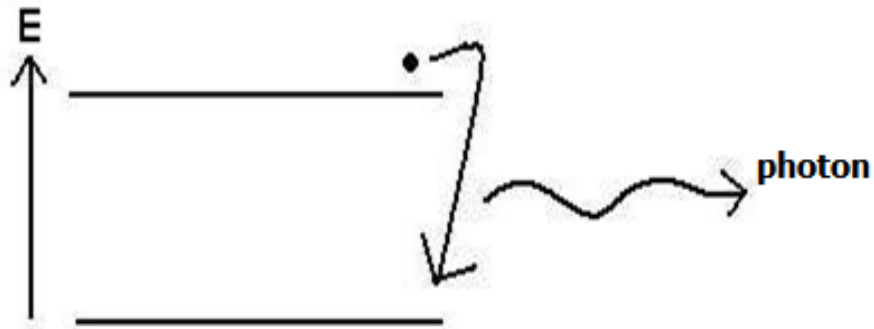

Figure 4.4 The energy release (Guoqing Huang)

Although this description is very simple, it reveals the core principle of the atom forming laser.

At the same time, the three conditions generating stimulated light emission are necessary, so that the atom can form the laser:

1) The generation of population inversion

In normal circumstances, any materials in equilibrium state are that the number of electron in low-energy state is greater than the number of electron in high-energy state. Because in a high-energy state electrons quickly return to the low-energy state after the external photon exciting the electron in low-energy state and jumping to high-energy state. This kind of upward and downward transitions are almost carried out simultaneously. Therefore, in order to obtain the population inversion, it requires an infinite the stimulated intensity to suddenly excite most of electrons in the low-energy state, and then jump to the high-energy state. And this light source with such large excitation intensity is difficult to obtain. Therefore, this also limits the use of lasers. At the same time such large exciting power may also damage the material. (*Xinzhi Sheng p.62*)

2) The resonant cavity

The resonant cavity of laser is consisted of two parallel end faces with high reflectivity. The laser materials will generate the stimulated light emission in resonant cavity.

If the laser material has reached the population inversion conditions in the resonant cavity, the light reflected back and forth between both end faces in the resonant cavity constantly excites out the stimulated emission in the dissemination process and generating photons add into the direction of dissemination by the way of the stimulated emission, and this process makes optical field generated by stimulated transition stronger and stronger.

Although there are also photons generated by the spontaneous radiation to add the process of light propagation, the light of spontaneous radiation is going to the various propagation directions. Only the propagation direction of those photons being parallel with the resonant cavity of the photons can be retained in the cavity, the rest will be suppressed. In addition, the frequency of the propagating light will be limited by resonant frequency in the resonant cavity, and only those lights that are suitable for the condition of resonant frequency in the resonant cavity can be strengthened, and the rest will be suppressed. So the main role of the cavity is in resonant cavity forming a stronger stimulating optical field with a specific frequency. The principle is drawn in Figure 4.5 and the product appearance of resonant cavity is shown in figure 4.6. (*Xinzhi Sheng p.62*)

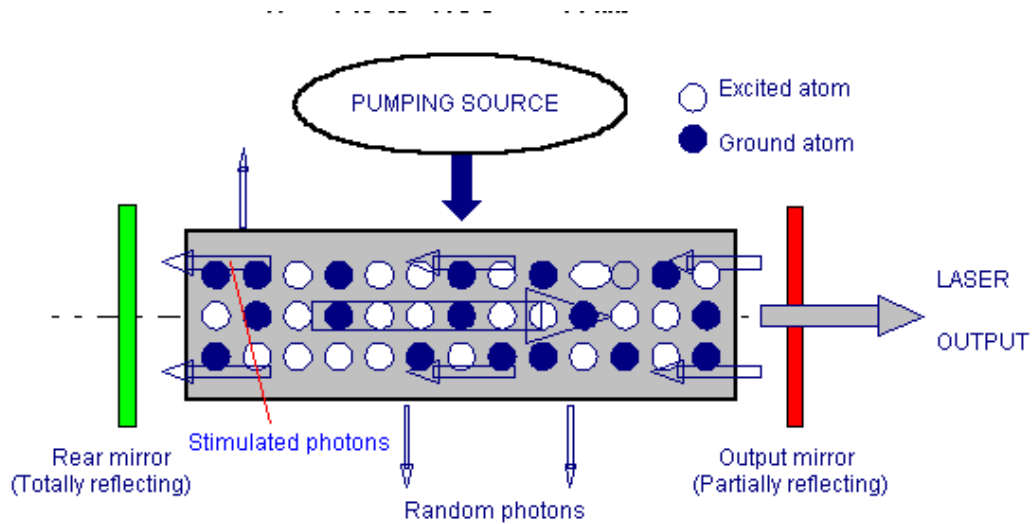

Figure 4.5 The principle drawing of resonant cavity (Xinzhi Sheng p.62)

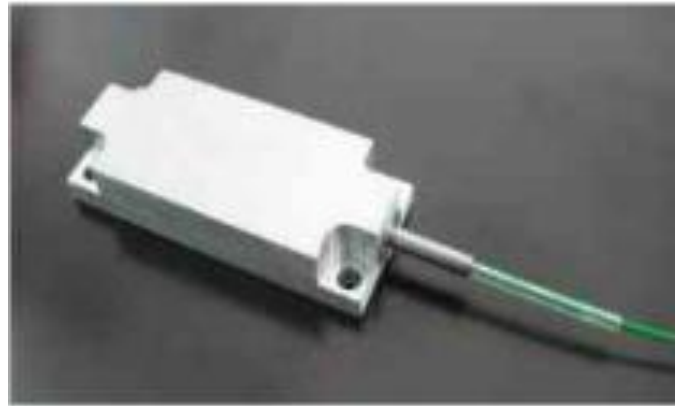

Figure 4.6 The product appearance of resonant cavity (Xinzhi Sheng p.81)

The resonant cavity has also another role: In the resonant cavity, a part of forming light is launched out by the end face of cavity and turned into the stimulated light emission, and the other part is reflected back by the end face, and it continues to excite out the stimulated emission in the resonant cavity. Therefore, as long as the laser material in the resonant cavity is maintaining the condition of population inversion, the continuous stimulated light emission can be obtained.

3) The power source

In order to make the laser to produce a laser output, it is necessary to make the gain of the laser material in the cavity to reach the threshold gain. That is to make the population inversion reach a certain level, and it is called the threshold inversion density. Therefore, the third element of the laser is to have a power source. It provides energy to be able to generate the threshold inversion density at least. This power source uses the form of electrical energy to provide the exciting power with the semiconductor laser. (Xinzhi Sheng p.62)

4.3 The basic structure and principle of fiber laser

Fiber laser is similar with other lasers. The typical structure of fiber laser consists of three parts: pumping source, the gain medium and resonant cavity. Pumping source commonly uses high-power semiconductor laser, the gain medium is fiber core doped with rare earth ions. The resonant cavity is mainly constituted by a fiber Bragg grating and other optical feedback elements. The optical fiber is placed between two selective reflector mirrors. The pumping light entrances the optical fiber from coupling optical system, and outputs laser through the collimation optical system and the filter. Its structure is shown in Figure 4.7. (*Haerbin engineering university*)

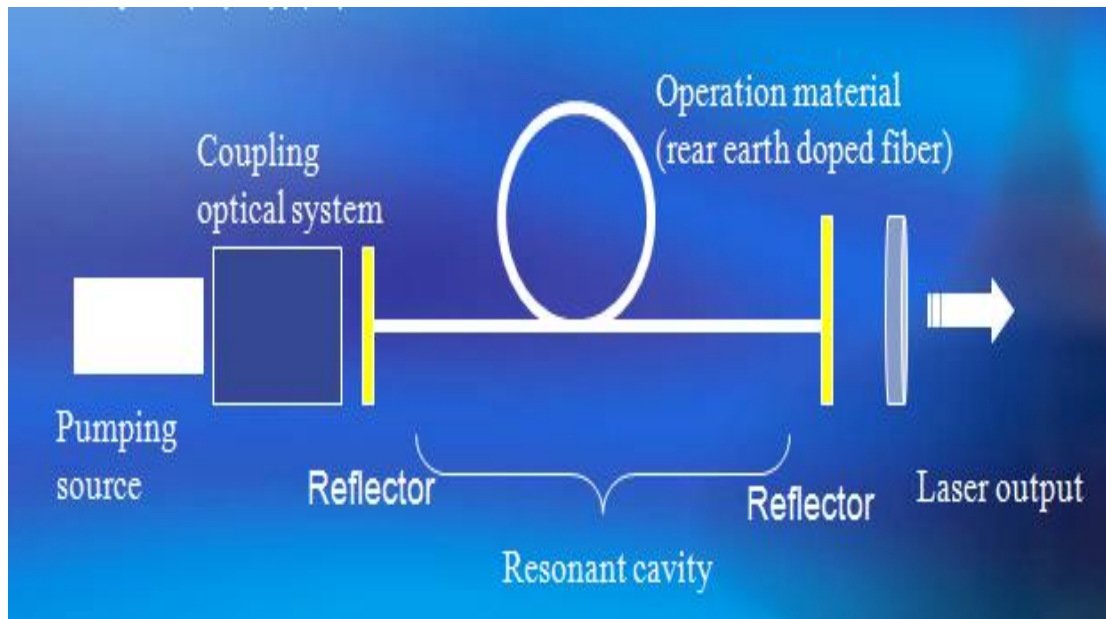

Figure 4.7 The typical structure of fiber laser (Haerbin engineering university)

When the pumping light incidence from the left reflecting mirror to the fiber core of doping the rare earth ions, it can be absorbed by doped rare earth ion. When the rare earth ions are absorbing photons, there occurs energy level jumping. To achieve population inversion, those particles will jump from the excited state to ground state by the form of radiation after particle relaxation and release out the energy from the right reflector mirror.

Fiber lasers have two kinds of lasing states, three-level and four-level. The energy level figures of these two kinds of lasing state are shown in Figure 4.8 and Figure 4.9. Pump (short-wavelength and high-energy photons) makes electrons jump from the ground state to the high-energy state E_4^4 or E_3^3 , and then jump to the laser upper level E_4^3 or E_3^2 by the radiationless way. When electrons further jump from the laser upper level to the lower level E_4^2 or E_3^1 , the laser will occur.

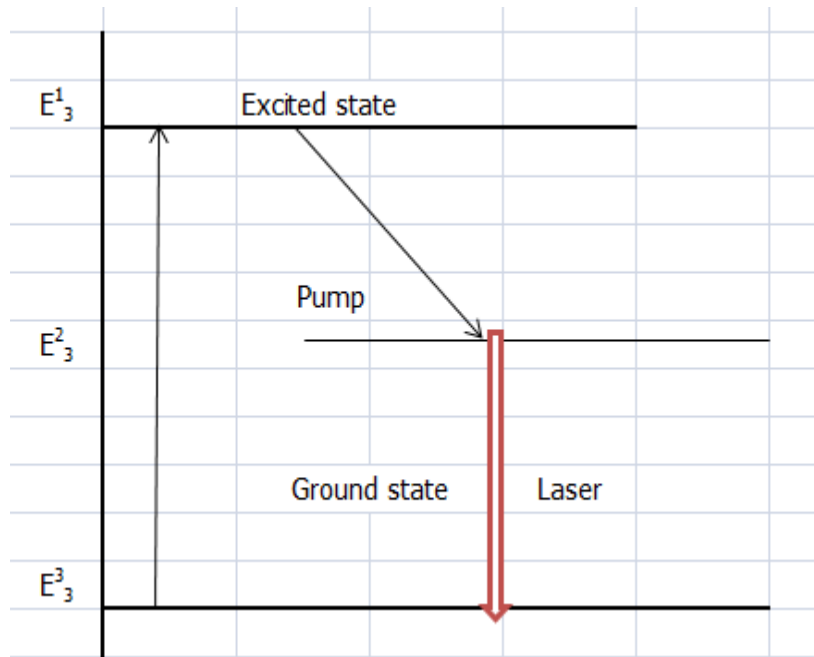

Figure 4.8 The three-level (Guoqing Huang)

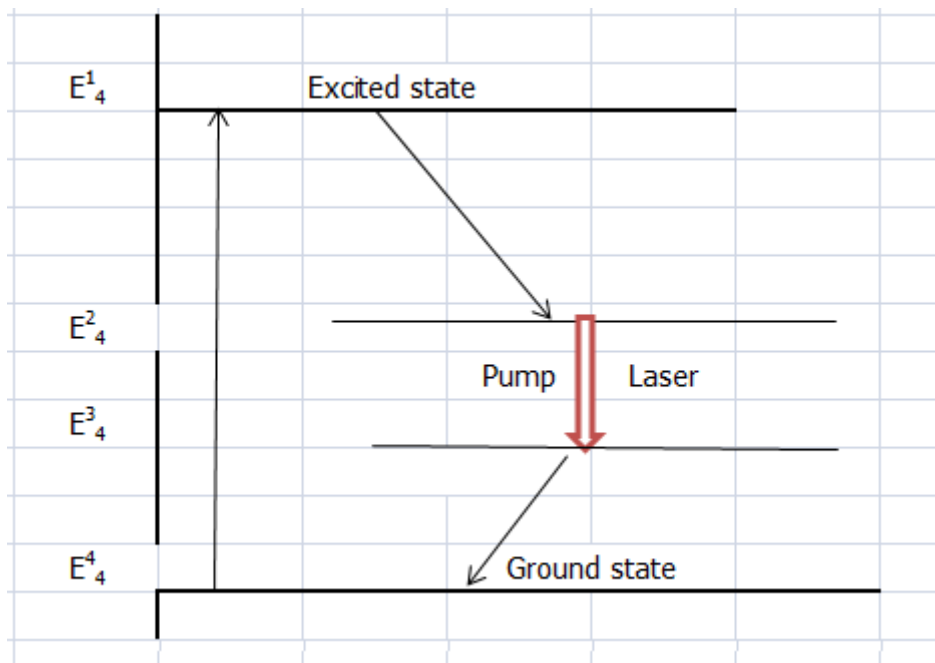

Figure 4.9 The four-level (Guoqing Huang)

5 Introduction of typical fiber lasers

Fiber laser is the typical of the third generation laser. Most countries focus mainly on the high power fiber lasers, mode-locked fiber lasers, double-clad fiber lasers (DCFL), narrow line-width fiber lasers, Raman fiber lasers (RFL), etc.

5.1 The classification of fiber laser

Fiber laser can be classified according to different criteria.

The classification can be based on the fiber material. First there are the crystal fiber lasers. The operation material is crystal fiber, for example ruby monocrystal fiber laser. Then there are the non-linear optical fiber laser, the Raman fiber lasers and Brillouin fiber laser that are representative typical. Then there are rare-earth-doped fiber lasers. The fiber's base material is glass, doped rare earth element into the fiber. Last is the plastic fiber laser.

The fiber lasers also can be classified according to the resonant cavity. For example F-P (Fabry P erot) cavity fiber laser, ring cavity fiber laser, DBR (distributed Bragg reflector) fiber laser, DFB (distributed feedback laser) fiber laser, "8" type cavity fiber laser, etc.

Then the classification can be based on the fiber structure. The typical products will be single cladding fiber lasers, DCFL, special fiber laser, etc.

If the classification is according to the laser characteristics, the typical products will be continuous fiber laser and pulse fiber laser.

Laser output wavelength is another important parameters of fiber lasers, so the fiber lasers also can be classified by the different laser output wavelength. For example, such as single wavelength fiber laser and multi-wavelength fiber laser.

Last is the classification according whether or not laser is mode-locked. For example: continuous fiber laser and mode-locking fiber laser. The mode-locking fiber laser can be also classified as active mode-locking fiber laser and passive mode-locking fiber laser or equivalent saturable absorber and saturated absorber.

5.2 High power fiber laser

One of the main development directions of the high power fiber laser is how to improve the output power of fiber laser. In 1995 the American scientists made an experiment that used four semiconductor lasers of 45 W to get a 110 W single mode continuous laser output from the pumping of fiber two sides. But in the subsequent time there was no breakthrough in this area, because at that time it was restricted by the fiber and pumping technique. In 2003, with the improvement of fiber technique and high power pumping technique, the output power of fiber laser was enhanced obviously. In 2004, American companies IPG developed a 100 kW fiber laser. Since then, all kind of

high power fiber lasers were developed, like the disk laser, etc. And in 24 April 2013, the first Chinese myriad-watt fiber laser was developed in Wuhan. China has become the second country who masters this technology. These research results have totally expanded the application area of fiber laser. (Chen Miaohai pp.1-3)

For the future development direction, the scientists are aware that the output of laser power from one fiber is limited. They want to use the laser beam combining techniques to improve the output power. There are two methods to realize, one is the coherent beam combining, the other is incoherent beam combining. These techniques can not only improve the output power but also maintain the quality of laser beam. So it is an important technique in high power fiber laser research and development. (Chen Miaohai pp.8-9)

Figure 5.1 indicates the highest power of fiber laser in every year from 1997. These fiber lasers are operating in a continuous way. Because there is no shortcoming of concentration quenching when the ytterbium ion is mixed in the fiber, it can maintain a high dosage concentration. Therefore using high power semiconductor laser array as the pump directly is very convenient. So the break record fiber laser after 1999 is to use the fiber that is mixed with ytterbium as the gain medium. (Chen Miaohai pp.4-5)

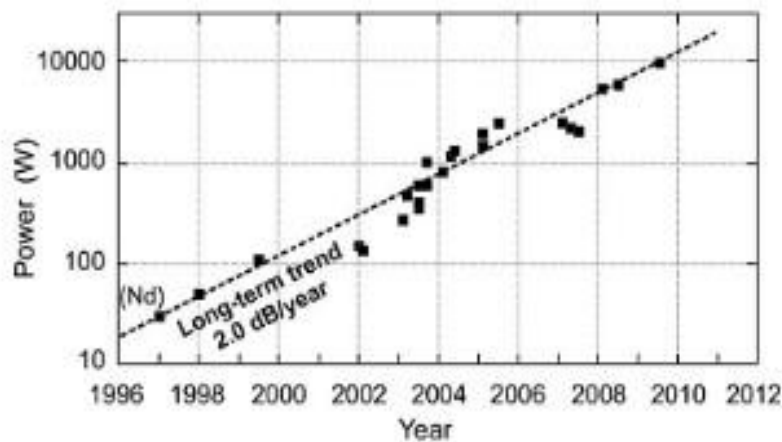

Figure 5.1 The highest power record of fiber laser in every year (Chen Guoliang p.4)

5.3 Double-clad fiber laser (DCFL)

When the absorption efficiency of pumping the laser was increasing, the output powers of fiber laser were increasing, too. In 1988 scientists have raised a double-clad pumping technique. In that time many scientists focused on the research of Nd doped DCFL. But the absorption band of Nd is very narrow, and the requirement of pumping source wavelength stability and accuracy is very high. However, the scientists find the Yb has a very wide absorption band, and the contracture of energy level is very simple. In the 21st century Yb doped DCFL has got a great breakthrough. There are hundreds or even thousands watt fiber laser appeared in commercial. (Ge zhendong pp.14-15)

The advantages of DCFL are:

- 1) The high output power of laser, because it can be pumped by several multimode semiconductor laser diode combined together.
- 2) It does not need a complex cooling device, because the surface of the fiber is very large but the volume of the fiber is very small.
- 3) The pumping wavelength range is very wide. Because the fiber mixed some rare earth element, it has a wide and smooth absorption spectral region.
- 4) The stability of the multimode pumping resource determines that this fiber laser has a high reliability.
- 5) The DCFL has a high laser beam quality; the other high power fiber laser cannot reach this.
- 6) It has high wall-plug efficiency.
- 7) The contracture is tight, secure and does not need a precision optical table and adapt poor working condition.

DCFL consists of:

- 1) Fiber core: fiber core is consisting of Si_2O_2 mixed with rare earth element. It is used as the gallery of laser oscillation.
- 2) Inner cladding which is the gallery of pump light source.
- 3) Outer cladding consisting of soft plastic which refractive index is low.
- 4) Protective coating from rigid plastic. This protects the fiber.

Figure 5.2 shows the composition of DCFL.

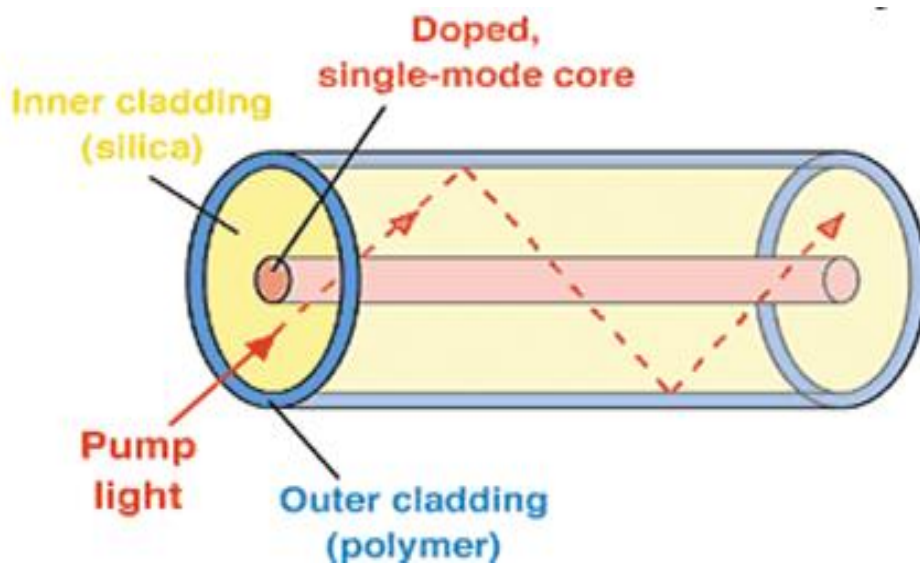

Figure 5.2 Contracture of DCFL (Spie)

The types of the DCFL

According to the position of the fiber core and the shape of the clap, the DCFL can be classified to offset type, rectangular type, square type and D type, as shown in Figure 5.2.

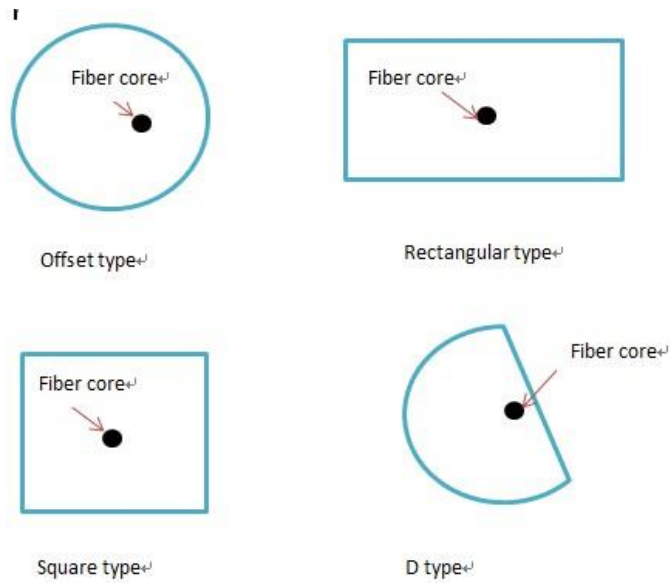

Figure 5.3 Four types of DCFL (Yang Zhang)

Pump coupling technique of DCFL

1) End-pumped coupling technique

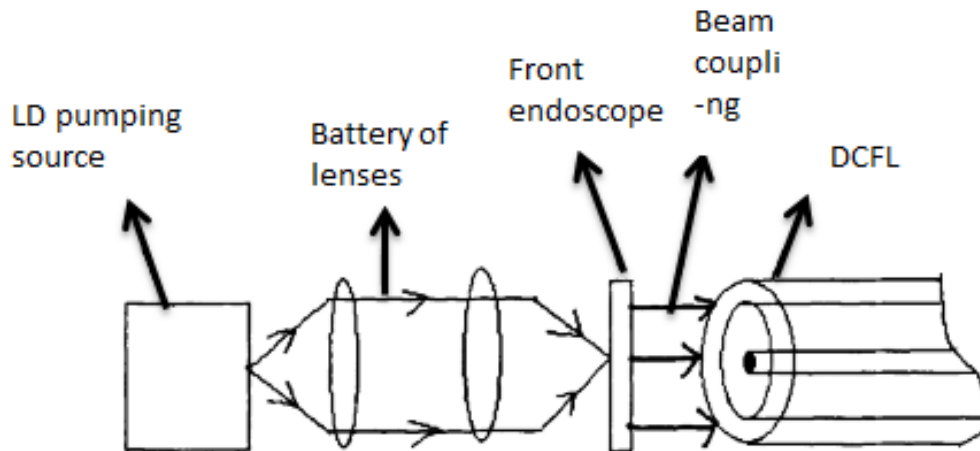

Figure 5.4 End-pumped coupling schematic diagrams (Yang Zhang)

From the end-pumped coupling schematic diagrams shown in Figure 5.4 it can be seen that, in end-pumping it is used the LD laser source to produce the pumping light, through the battery of focusing lenses, then coupling the laser beam into the DCFL.

The structure of end-pumping is very simple, easy to operate and the coupling efficient is over 50%. When the requirement of the coupling efficient is not high, end-pumping is a very good choice. But the disadvantages of end-pumping are also very obvious. Firstly, it occupies the two face of the fiber to limit the efficient of the pumping laser access to fiber. On the other hand the pumping

wastage is very large when the double clad fiber needs to connect with other fiber in some special case.

2) Side Pump coupling technique

Because the end-pumped coupling technique has so many disadvantages, the more efficient pumping method is needed.

There are many kinds of side pump coupling; the following paragraph will introduce some typical side pump coupling techniques.

a) V-type groove

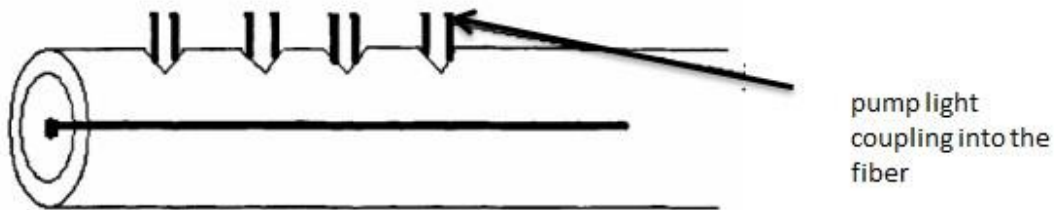

Figure 5.5 V-type groove pump coupling schematic diagrams (Yang Zhang)

The Figure 5.5 shows the schematic diagrams of V type groove pump coupling. It is made by stripping a bit of DCFL outer cladding in the first, then corroding a series of “V” type groove on the inner cladding. The laser produced by LD pump source is focusing through the “V” groove, then change the direction base the axle line of double clad fiber.

This pumping technique has conquered two shortcomings of end-pumped coupling. It can reach a higher coupling efficient, and the double clad fiber can be connected with other fiber too. But the groove depth must be lower than the half of the inner cladding depth, the reflect laser area is also very small. It is a very expensive method, too.

b) Insert the micro-prism

As shown in Figure 5.6, the LD pump source produces the laser beam, then it incidences on the micro-prism. Through the reflect of micro-prism, it couples the pump light to the fiber. In this figure the ϕ_{\min} and ϕ_{\max} is the minimum and maximum angle of spread in the fiber after the pump light has been reflect.

Compared with the V-type groove technique, after inserting micro-prism the fiber laser can produce the smooth radius beam pump source. But it has the same shortcoming: the process is complex and it is difficult to produce.

with Yb³⁺ to amplification. It has been applied in dispersion compensation in holey fiber. In 2004 the RHML fiber laser was researched, It used the semiconductor laser as the loss adjuster. In 2006 Chinese scientists designed a passive mode-locking laser based on nonlinear polarization rotation effects. The fiber coil contracture was the polarization controller and use the fiber elate-optical effect was used to change the birefringence in the beam, controlling the optical wave polarization state in the fiber. Figure 5.7 illustrate a product of a mode-locked fiber lasers. (Chen Guoliang pp.23-34)



Figure 5.7 Mode-locked fiber laser (Nuphoton)

Active mode locking laser

The principle of active mode locking ring cavity fiber laser doped with erbium is shown in the figure 5.8. An electro optical modulator or AOM (acoustic optical modulator) is insert in the straight cavity or ring cavity. Usually use the LiNO₃ is used for the electro optical modulator, its size is very small, easy to be integrated, and also easy to couple with fiber. But the LiNO₃ electro optical modulator is sensitive to the polarization, so the active mode laser usually inserts a polarization controller in front of the modulator. (Chen Guoliang pp.23-34)

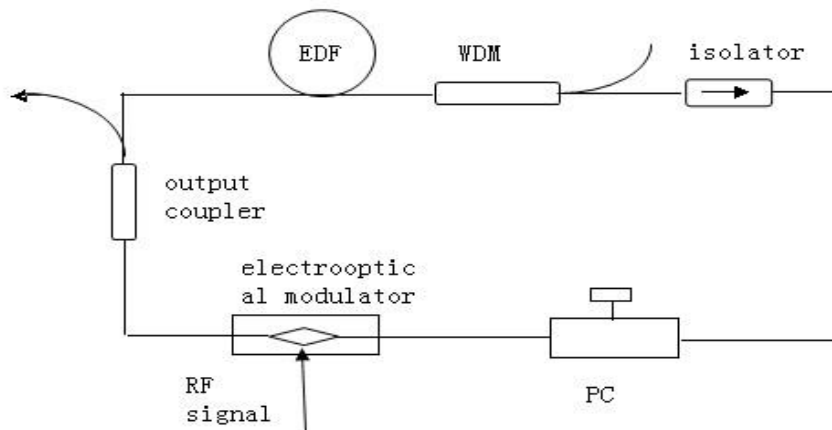

Figure 5.8 Active mode locking fiber laser (Yang Zhang)

EDF	erbium doped fiber
PC	polarization controller
RF	radio frequency
WDM	wavelength division multiplexer

Compared with common fiber laser the advantages of active mode locking are easy self-starting, easy to set high repetition frequency and even adjusting the repetition frequency. But the active mode locking laser spectrum is narrow, so it is difficult to get ultra-short pulse. If the pulse width, and stability question have been solved, the active mode locking lasers will be widely used. (Chen Guoliang pp.23-34)

Passive mode-locking laser

The Passive mode-locking laser doped with rare earth element use the fiber as the resonant cavity, the gain medium is the fiber doped rare earth element, and use the nonlinear effect to modulate then output a stable ultra-short pulse array. It has a small volume and a simple structure, and it does not need to adjust laser path all the time. Due to the limit of doped fiber's core diameter. Coupling of the high power energy to the operation material is difficult. (Chen Guoliang pp.23-34)

At present there are three methods to realize the Passive mode-locking laser: the saturable absorber mode lock, the "8" type cavity mode lock and the nonlinear polarization evolution mode lock. (Chen Guoliang pp.23-34)

5.5 Q-switch fiber laser

Q-switch means that through the change of resonant cavity's Q value it is released the energy that storages in active medium, then gain a laser intense radiation is gained in a certain pulse width.

Q-switch fiber laser has two categories based on the Q-switch pattern.

Active Q-switch: it is needed to use the electro-optical switch to control the Q value in the cavity.

Passive Q-switch: it is needed to insert a saturable absorber in the cavity, for example, ZnS crystal.

Figure 5.9 is a simple erbium-doped femtosecond laser, where the Fresnel reflection from a fiber end is used for output coupling.

The Q-switch fiber laser is widely used in distributed sensing, laser ranging, biomedical, etc. in recent years. The use of mass gain fiber makes the pulse energy to be a very high value. In addition, the SBS has been found and it can be used as saturable absorber to realize the passive Q-switch, it can gain a higher peak power. Duration time of Q pulse is shorter. And it also can realize All-fiber structure. But the stability is not very ideal; it is waiting a further research. (Chen Guoliang pp.21-22)

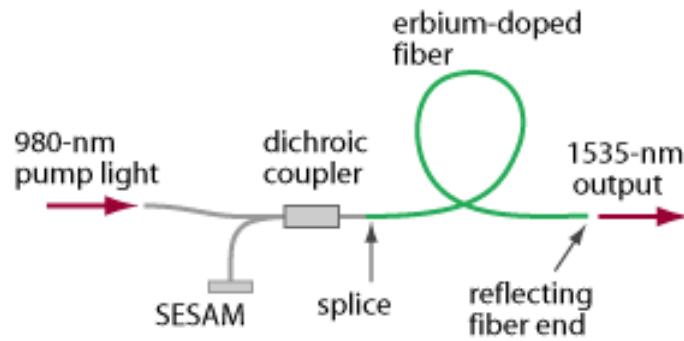

Figure 5.9 Simple Q-switch fiber laser schematic diagrams (Rp)

5.6 Raman fiber laser (RFL)

Stimulated Raman scattering is a very important non-linear process in fiber's non-linear optics. It is interaction between high intensity lasers and optical Carrier's molecular vibration pattern, then producing nonlinear optical effect. From Figure 5.10 research we can see that RFL is nonlinear optical fiber laser. Because of the common fiber laser, the wavelength is almost the same when the single-mode output power is changed, but the Raman fiber laser in a certain single-mode output power while the wavelength is very wide.

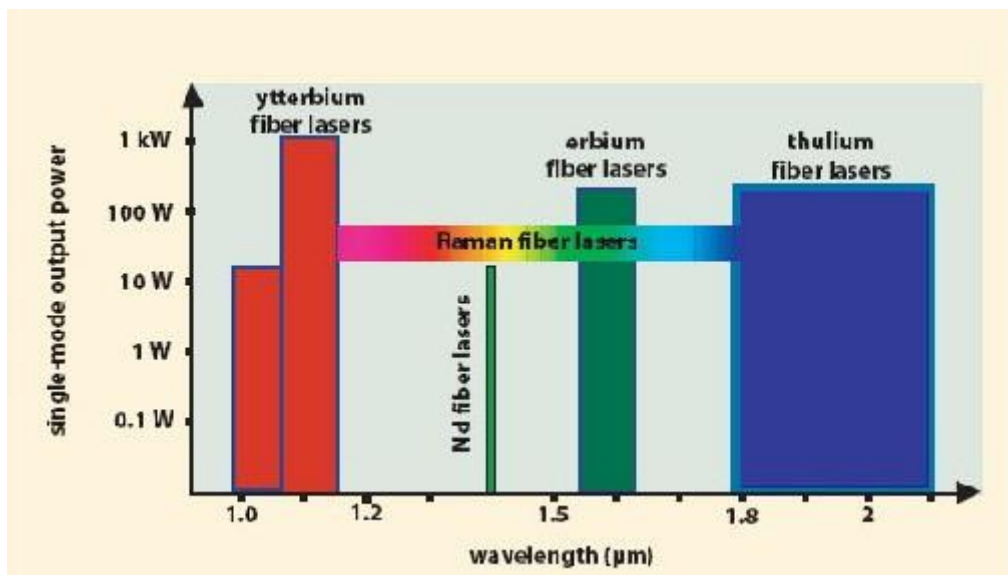

Figure 5.10 Wavelengths available with single-mode fiber laser (Qu Yanji p.12)

The main gain medium of RFL is phosphor-silicate fiber and germanium-silicon fiber. Due to the fact that research progress of RFL is rapidly developed, the performance of RFL is greatly improved. It already is a common commercial product. Many companies in America and Europe have provided 5 W Raman amplification pump modules.

5.7 Photonic crystal fiber laser (PCFL)

PCFL mainly uses the characteristics that choose the near-infrared light and visible light area of the photonic crystal fiber's ZDP (zero dispersion point). The following figure 5.11 is showing the basic structure of photonic crystal fiber: air cladding, active core protective coating and the multimode pump cladding. (Zuo Weilli pp.9-15)

In 2000, some scientists made a report on the PCFL: in 2001 a British University realized the double clasp PCF structure and the single transverse mode operating. In 2003, some German and Danish scientists researched the 1070 nm wavelength, 80 W output power, 78 % slope efficiency of PCFL. In 2008, Chinese Xi'an research institution has found the 95.8 W output power and 90.2 % coupling efficiency laser output. (Yuan Shuzhong pp.11-12)

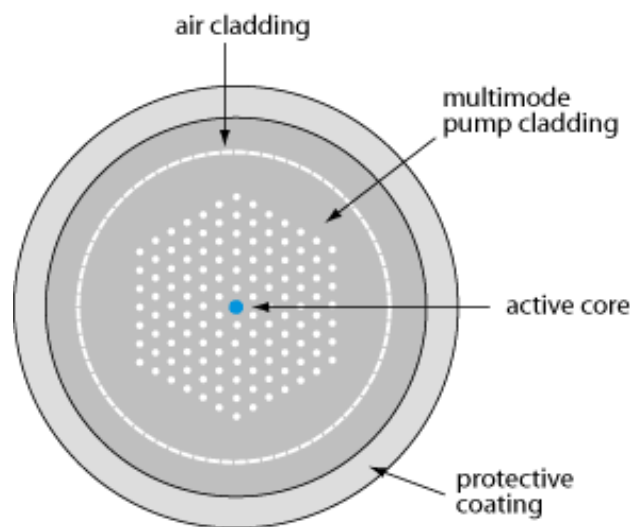

Figure 5.11 Basic structure of PCF (Rp)

The characteristics of photonic crystal fiber

1) Endlessly Single Mode; Large-Mode Area

Endlessly Single Mode means that fiber cut-off wavelength is short. There is no need to reduce the diameter of fiber core, but it needs to design the value of d/A (d is ventage diameter of inner clapping; A is the center interval of ventage). Then the PCF can realize the endlessly single Mode transfer. This is a unique advantage compared to common fiber.

2) High numerical-aperture

The light collecting capability of fiber is mainly related to fiber numerical aperture. High numerical-aperture PCF can guarantee the pump light's efficient coupling, then improve the intersect between pump light and signal light, and increase the absorption efficiency of pump light.

3) Dispersion characteristic

The Dispersion of PCF relies on the cladding's size, shape and array. But the photonic crystal fiber is designed very flexible, and then it can easily control the dispersion measure of PCF.

4) Nonlinear effect and double refraction effect

High double refraction PCF has these advantages: Product process is simple, it has freedom design degree, and it is not sensitive to the change of the temperature.

5.8 Narrow line-width fiber laser

Narrow line-width fiber lasers are operating in a single longitudinal mode oscillation frequency, and then have a favourable noise ratio. The common operating method of narrow line-width fiber laser has distributed feedback. Because the narrow line-width fiber laser has the advantage of narrow line width, and low noise, it is widely used in optical fiber sensing, high resolution spectrograph and optical fiber communication area.

The early research of narrow line-width fiber laser was focused on fixed wavelength; Vibration wavelength is controlled by the filter, for example Bragg grating.

Cavity configuration of narrow line-width fiber laser

The common cavity configuration of narrow line-width fiber laser has the linear cavity and ring cavity.

- 1) Linear cavity: The structure of linear cavity is very simple; there are short-straight cavity, composite cavity and Fox-Smith cavity. Short-straight cavity is through reducing the influence of hole-burning effect to gain the single frequency laser.
- 2) Ring cavity: Through the fiber directional coupler to form all kind of circle structure, this structure can eliminate the hole-burning effect. There are ring resonator, Sagnac fiber loop mirror, circulator, composite cavity and other structures. As shown in Figure 5.12 the connecting arm of coupler 1 and 2 consists of a ring resonator. The coupler has the back donation.

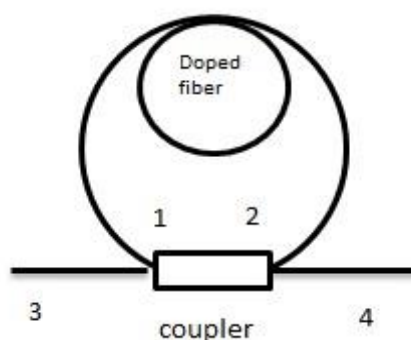

Figure 5.12 ring resonator (Yang Zhang)

The method to realize the single frequency operation

- 1) F-P etalon can be used as frequency-selecting and limiting the wideband. But the optical surface of the etalon easily to forms sub-cavity with the endoscope and it goes against the formation of Single frequency operation.
- 2) Use the Bragg grating.
- 3) Incoherent technology: in order to eliminate the hole-burning effect, the polarization state of cavity's wavelength must be control.
- 4) Saturable absorber: add the saturable absorber must be controlled in the laser cavity to restrain the jump mode.

5.9 Multi-wavelength fiber laser

The multi-wavelength fiber laser is widely used in optical fiber sensing, wavelength division multiplexing optical network, photonic microwave technology. It has a multi-wavelength output, compact structure, low cost, good laser beam quality and low insertion loss. In recent times, people are researching how to get a multi-wavelength laser that is stable and also has suitable parameters. It can adopt the different laser gain medium, different resonator structure and different filter to satisfy the above requirement.

The classification of multi-wavelength fiber laser

According to the cavity structure: multi-wavelength fiber laser can be classified as linear cavity multi-wavelength fiber laser and ring cavity multi-wavelength fiber laser.

According to the gain medium: multi-wavelength fiber laser can be classified as multi-wavelength erbium doped fiber laser, multi-wavelength Raman fiber laser, multi-wavelength semiconductor fiber laser and multi-wavelength hybrid gain fiber laser.

Multi-wavelength semiconductor fiber laser

With the development of semiconductor technology, use the SOA (as the figure 5.13 shows) is used as the gain medium more and more commonly.

There are many unique advantages of SOA:

- 1) SOA belongs to the inhomogeneous broadening gain medium. It can realize the stable multi-wavelength output in the room temperature without addition technology.
- 2) SOA is based on the Electrical stimulation method, and then the laser will get proper functioning without inserting the pump. So the contracture of multi-wavelength semiconductor fiber laser is relatively simple.

- 3) It will obtain a beamy and smooth gain bandwidth in the SOA's wavelength band, so if the SOA is the gain medium it will realize more multi-wavelength output.
- 4) Because the SOA has a small volume, easy integration, it has an obvious advantage in fiber optics and integrated optics and laser system miniaturization design field.

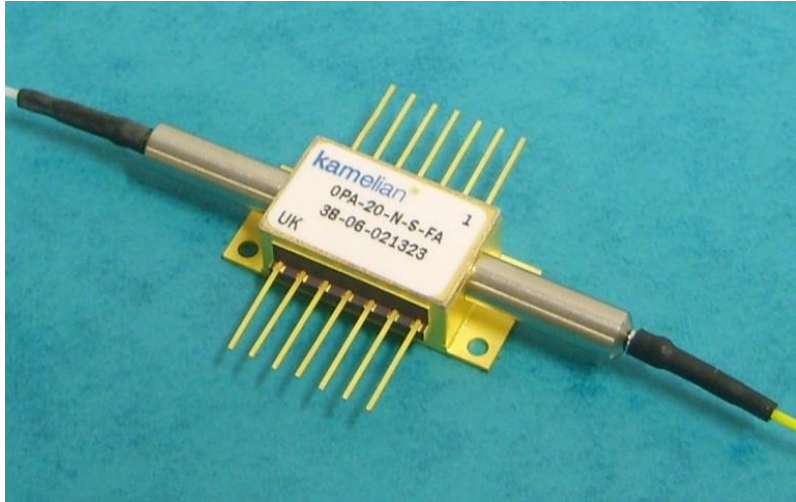

Figure 5.13 semiconductor optical amplifier (Kamelian)

6 The applications of the fiber laser

As the fiber laser technology is rapidly developing and maturing, it gets more and more attention. Therefore, not only the different powers for fiber lasers are emerging endlessly, but also the applications are wider in different fields.

6.1 The application value of fiber laser

Fiber lasers have attracted widespread attention in recent years, because they have the advantages unmatched by other lasers. The main performance is:

- 1) In the fiber laser, optical fiber is not only a laser medium but also the medium of guided wave of light. Therefore, the coupling efficiency of the pump light is quite high, and coupled with the fiber laser, it can easily extend the length of the gain, so as to fully absorb the pump light.
- 2) The geometric shape of the optical fiber has a large SVR (surface area to volume ratio), and the heat dissipation is faster. So fiber lasers can work in ambient temperature of $-20 \sim 70$ °C. At the same time it does not require a large cooling system and simply air cooling can be good. It can also work in harsh environments, such as in high-impact, high-vibration, high-temperature environments and it normally operates under the conditions of dust. Its thermal load of operation material is quite small, and can produce high-light and high-peak power. It has reached 140 mW/cm.
- 3) The fiber laser is small in size and it has a simple structure. The operation material is flexible medium and can be designed to be very compact, flexible and easy to use.
- 4) The doped fiber as a laser medium doped with rare earth ions and the doped substrate is also having a number of adjustable parameters and selectivity. Fiber lasers may be operated within a very wide range of spectrum (455-3500 nm). In addition, the fluorescence spectra of the GOF (glass optical fiber) are relatively wide, and can insert the appropriate wavelength selector to obtain the tunable fiber laser. The tuning range has been up to 80 nm. Fiber lasers have long service life, the average time between failures is 10000 to 100000 hours.
- 5) Fiber lasers are also easy to implement single-mode, single-frequency operation and ultra-short pulse.
- 6) Fiber lasers have high gain and low noise, and fiber-to-fiber coupling technology is very mature, and the gain and polarization are unconcerned.
- 7) The beam quality of fiber laser is better. It has better monochromaticity, directivity and temperature stability.
- 8) The use of silicon optical fiber in fiber laser technology is now very mature, so we can produce high-precision and low-loss optical fiber. This greatly reduces laser cost. (Laserfair)

6.2 The applications of different power fiber laser

In generally the average power of laser is below 100 W. It is called as the low-power laser, and more than 1 kW is called as the high-power lasers.

1) The low power fiber laser

The earliest breakthrough in fiber laser field in China is the laser marking market. The pulse fiber laser of 5 - 100 W is popular in the markets, and most are 10 W and 20 W pulse fiber lasers. This also provides good opportunities for the low power fiber laser manufacturing, because they are easier to manufacture. These kinds of lasers are mainly used in laser marker, laser trimmer, micro-machining, precision drilling, and other fields.

For low power pulse fiber lasers, there are the following advantages:

- Energy of single pulse is high
- Average output power is high
- The beam quality is high
- Maintenance-free operation

STR series pulsed fiber laser is a compact module up to 100 W output power with fiber delivery through a near diffraction limited beam. The following Figure 6.1 and Table 6.1 are 10 W pulse fiber laser and the technical requirements of 10 W-100 W pulse fiber lasers. (*Wuhan Sintec Optronics Co. Ltd*)



Figure 6.1 The 10 W pulse fiber laser, STR-P10 (*Wuhan Sintec Optronics Co. Ltd*)

Table 6.1 The technical requirements of 10 W-100 W pulse fiber lasers (Wuhan Sintec Optronics Co. Ltd)

Model	STR-P10	STR-P20	STR-P30	STR-P50	STR-P100
Central Emission wavelength (nm)	1060-1085	1060-1085	1060-1085	1060-1085	1060-1085
Polarization	Random	Random	Random	Random	Random
Nominal average output power (W)	10	20	30	50	100
Pulse energy (mJ)	0.5@20kHz	1.0@20kHz	1.0@20kHz	1.0@20kHz	2.0@20kHz
Pulse repetition rate (kHz)	20-80	20-80	30-80	50-100	50-100
Pulse width (ns)	90@20kHz	120@20kHz	120@30kHz	120@50kHz	200@50kHz
Typical beam quality (M^2)	<1.5	<1.5	<1.5	<1.8	<2.0
Collimated beam diameter (mm)	6-8	6-8	6-8	6-8	6-8
Output power tunability (%)	10-100	10-100	10-100	10-100	10-100
Long term power stability (8hrs)	<3%	<3%	<3%	<3%	<3%
Length of beam delivery fiber (m)	2.0	2.0	2.0	2.0	2.0
Operating voltage	24VDC	24VDC	24VDC	24VDC	220VAC
Typical power consumption (W)	80	150	250	350	500
Cooling	Air	Air	Air	Air	Air
Operating temperature ($^{\circ}$ C)	0-45	0-45	0-45	0-45	0-45
Dimension WxDxH (mm)	260x391x120	260x391x120	260x391x120	484x490x185	484x490x185

2) The medium power fiber laser

As the competition is more and more fierce, most fiber laser manufacturers began to enlarge their laser markets to extend to develop the medium power fiber laser for surviving and for more profitable markets. The development of fiber lasers from low power to medium power is not as difficult as the high power fiber laser.

3) The high power fiber laser

The development of high power fiber laser is difficult, because the cladding-pumping technology must be solved.

Since E Snitzer described for the first time the cladding-pumped fiber laser in 1988, the cladding-pumped technology has been widely applied to the field of fiber lasers and fiber amplifiers and become the first route for the production of high power fiber lasers. The characteristics of cladding-pumped technology determine this kind of fiber laser outstanding performance of the following aspects:

- High power
- Air cooling
- Wide Pump Wavelength
- High efficient

- High reliability

At present, the fiber lasers have achieved the cladding-pumped technology including three main categories: single-ended linear cavity pumped fiber laser, linear cavity double-end-pumped fiber laser and all-fiber ring cavity double-clad fiber lasers. This kind of lasers are mainly used in metal cutting, welding, metal quenching and coating, quick printing and others. (Jianhong Liao)

In this field, the United States is taking its place in the front ranks of the world. IPG in United States launched the Yb-doped double-cladding high power fiber lasers with the power of 700 W, 1 kW and 10 kW. It launched out the welding test of myriawatt fiber laser in 2005 shown in Figure 6.2. The auxiliary equipment of myriawatt fiber laser is shown in Figure 6.3 and the technical requirements of YLR series fiber lasers are shown in Table 6.2.



First welding tests with 10.4kW in steel using protective gas and cross jet

Figure 6.2 The welding test of myriawatt fiber laser (Yaodong Li p.8)



Standard connector for the 10kW High Power Fiber Laser



Water supply for the 10kW High Power Fiber Laser

Figure 6.3 The auxiliary equipment of myriawatt fiber laser (Yaodong Li p.8)

Table 6.2 The technical requirements of YLR series fiber lasers (Yaodong Li p.10)

Typical Specification					
Optical Parameters	Unit	YLR-1000	YLR-2000	YLR-5000	YLR-10000
Mode of operation		CW, QCW	CW, QCW	CW, QCW	CW, QCW
Central emission wavelength ¹	nm	1070-1080			
Nominal output power ²	W	1000	2000	5000	10,000
Beam quality (BPP)	mm*mrad				
Basic ³		5	9	17	23
Premium ³		3.5	5	12	17
Special ⁴		0.34	2.5	4.5	6
Output power stability (long term)	%	+/-2	+/-2	+/-2	+/-3
Output fiber delivery diameter ⁵	μm	50-100	50-200	100-300	200-400
Electrical Parameters					
Typical electrical requirements	V AC	208-480	380-480V, 3P+PE, 50 - 60Hz		
Maximum power consumption	kW	5	10	22	50
Max. cooling water consumption	m ³ /h	0.6	1.2	3	5
Cooling water temperature	°C	5-30	5-30	5-30	5-30
General Parameters					
Dimensions (WxDxH)	cm	80x80x80	80x80x80	86x81x150	146x81x150
Weight	kg	150	250	500	1000
Ambient Temperature	°C	0-45	0-45	0-45	0-45

¹ - "Eye-Safe" wavelength @ 1.5μm is available on request.
² - Nominal power is specified at the end of fiber delivery. Intermediate power levels are available with a 500W increments (e.g. 500, 1500W, 2500W, 5500W, etc.)
³ - After optical coupler and passive beam delivery cable.
⁴ - Please contact IPG to determine an exact configuration.
⁵ - Minimal diameter. Larger diameters are available.

6.3 The applications of different fields

With the rapid development and maturing of fiber laser technology, the advantages of fiber laser has been recognized, and market demand and applications are further expanded including almost all areas. The fiber laser is referred to as common means of processing in manufacturing systems.

6.3.1 Industrial applications

Fiber lasers are gradually penetrated into the applicative field of conventional laser technology, whether it is in low-power marking applications or high power machinery and materials processing applications. Fiber lasers are easy in operation, have high accuracy, good stability and flexibility, and enable to make users to benefit from it, which also drives the rapid growth of the fiber laser market.

1) Fiber laser marking

Fiber laser marking system has a small size and it is completely maintenance-free. The excellent quality of the optical mode of the fiber laser is particularly suitable for applications in high-precision marking. Single-mode fiber with a beam collimating device and integrated optical focusing system provides a system of beam delivery with 7 m distance.

A fiber laser marking system consists of one or two 25 W fiber lasers, one or two scan heads used to guide the light to the work piece, and a computer controlling scan heads. The efficiency of this

design is four times more than by splitting the 50 W laser beams into two scanning heads. The system has a maximum range of marking 175 x 295 mm and the spot size is 35 μm . When the scanning end has a distance of 100 mm with the work piece, the spot size can be reached to 15 μm . For example, the GN-F series of fiber lasers marker are used for marking the type of product and basic parameters in products as shown in Figure 6.4. These are usually seen in the life and production. (*NNEEDHAM Laser*)



Figure 6.4 The marking of GN-F series fiber laser marker (NNEEDHAM Laser)

2) Fiber laser welding

Fiber laser has a good beam quality and large continuous power. It is suitable for deep penetration welding and heat conductivity welding. The cw-laser may provide the laser pulse by modulating and then obtaining the high peak power or low average power. This is suitable for the welding requiring low heat quantity. The modulation frequencies of high power laser is up to 10,000 Hz, and thus it is able to improve the capacity of the pulse welding. Typical spot welding relies on the galvanometer to transfer beam, thereby it completes the welding of the razor blade and subbase, and fully utilizes the pulse function of fiber laser. The light spot of fiber laser is small and focal length is very long, thus the ability of long-range laser welding will be enhanced. Other examples of fiber laser welding include: all welding of drive disk assembly, deep penetration welding of marine thick steel plate, battery pack seal welding and high pressure seal welding etc. Figure 6.5 shows the effect of the fiber laser welding of the turbocharger. (*Yunying Meng p.35*)

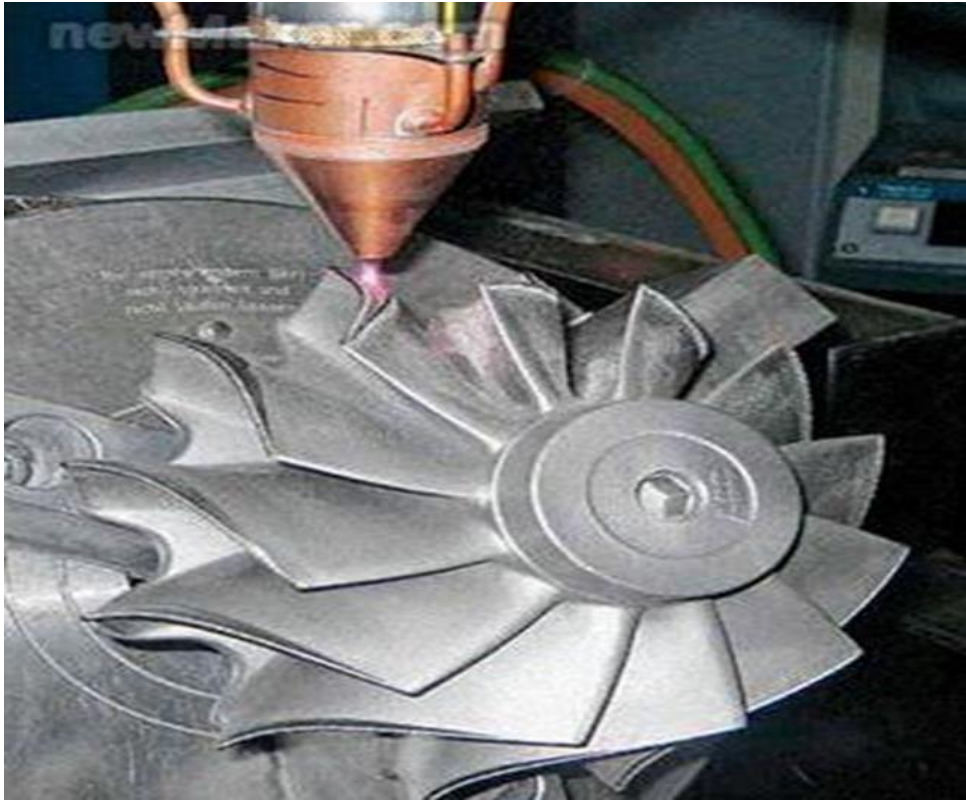

Figure 6.5 The repair welding of the turbocharger and effect of welding (Yunying Meng p.35)

3) Warping material

Fiber laser molding or kinking is using a technology of changing the curvature of metal plate or hard ceramic. And by using the central heating and quick cooling to cause plastic deformation in hot zone of fiber laser, it permanently changes the curvature of the target work piece.

4) Surface treatment of fiber laser

The laser is a high heat source that hardens the surface of various tools. This heat source is able to change the metallographic structure of the material, and make the surface hardening, thereby improving the abrasive resistance of the material. For surface hardening treatment, the type of fiber laser selected depends mainly on the part or component itself, and the most hardening treatments need to use a continuous beam. For example, hardening of the track will be used on the most industrial tools. Hardening of precision parts needs to use pulse laser. Figure 6.6 shows the application of laser surface hardening treatment. *(Yunying Meng p.43)*



Figure 6.6 Thread hardening treatment (Yunying Meng p.43)

5) Fiber laser cutting machine

The perfect combinations of robot and fiber lasers achieve the three-dimensional cutting. The cutting equipment is compact, and has small footprint and flexible processing. Wuhan Farley laser lab has been committed to the research and development of laser technology in the field of automobile manufacturing for years. At present, Wuhan Farley laser lab launched a three-dimensional fiber laser cutting machine, and is applicable to three-dimensional cutting of automotive metal parts. This kind of cutting machine is fixed on hanging upside down robot or vertical robot controlled by PLC integrated control system. The equipment is mainly producing parts of 0.5-2 mm thickness and processing three-dimensional parts. It replaces the traditional processing methods, reduces mold investment and greatly reduces the development cycle of the automobile manufacturers. At the same time, it improves processing efficiency and cutting accuracy of the work piece. Figure 6.7 is showing the fiber laser cutting machine. (Machine365)



Figure 6.7 the fiber laser cutting machine of Wuhan Farley laser lab (New maker)

6.3.2 Military applications

The narrow line width fiber laser is used widely in the military field, especially is the high-precision target designation and range finding technology of ultra-distance. At present, the measuring distance of general commercial laser rangefinder is 10-20 km, which is due to its dynamic range and measuring sensitivity to be limited, and its performance cannot meet the demand of the military

ISR (Intelligence, Surveillance, Reconnaissance) platform. However Guangke communication developed a 1550 nm ultra-narrow line width fiber lasers. It can be widely used in the target designation and range finding outside several hundred kilometers, and thereby greatly reduce the cost of the ISR platform.

At present, high-power double-cladding fiber lasers have the advantages of high efficiency, small size, light weight, and low cost etc. and they also have the most promising direction in the development of military laser weapons.

The development of laser weapons has been a focus in the military field. In 2006, the U.S. Navy developed a 100 kW fiber laser pod of airborne in 10 years. And U.S. Air Force in 2008 began to explore innovative techniques and methods of advanced fiber laser system. Therefore, the fiber laser weapons may become the protagonist of the future.

6.3.3 Biomedical engineering

In medical instruments, the practical examples are the processing of dilator endoscopes and catheters etc.

The so-called dilators, is the common name of instruments to treat the occlusive disease. For example, the coronary stent is shown in Figure 6.8.

Generally, the size of the stent is very small, such as the stent main parameters: diameter of 0.8-2 mm, screen width of 0.05-0.07 mm, thickness of 0.08-0.4 mm, precision of cutting process $\pm 5 \mu$ m. This requires that the laser must have a very good beam quality and small spot. In addition, the good stability of the laser is necessary. Only fiber lasers can achieve these requirements, such as using YAG laser cut stent with burr phenomena on the surface, and the large heat-affected zone, affecting the flexibility of the stent. (*Jiayu Huo p.76*)

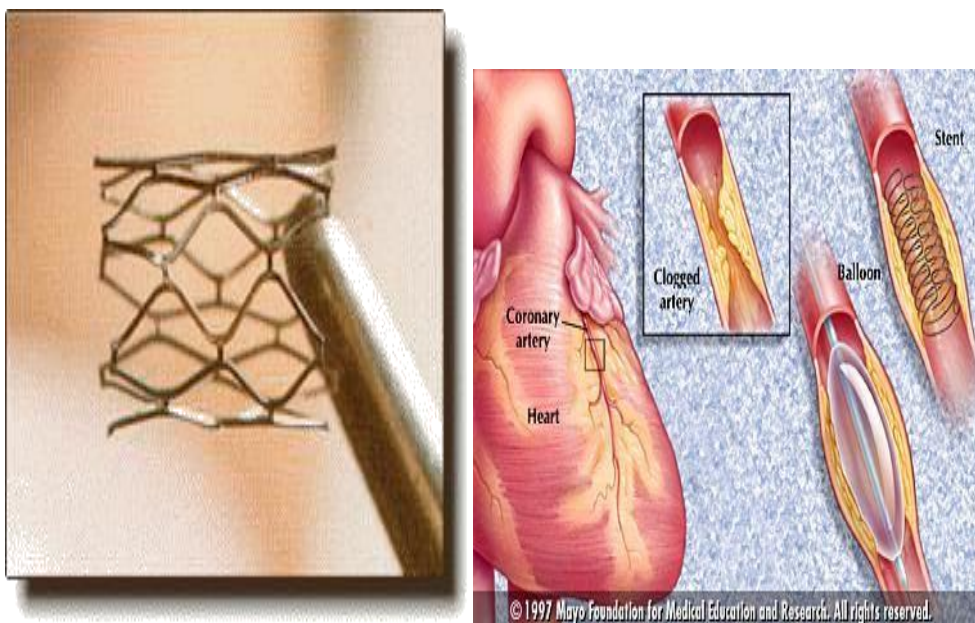

Figure 6.8 The coronary stent (*Jiayu Huo p.76*)

6.3.4 Communication applications

The unique advantage of fiber laser drive enhances the development of optical fiber communications. Fiber lasers are also the key technology for faster, more stable communication. It can not only achieve continuous output of the laser, but also can generate femtosecond pulses, and is able to achieve information transmission of high-speed, high-capacity and high-quality, and to provide protection for the realization of all-optical communication system.

7 Development prospects of fiber laser

In 2012, the environment of the global economy is in a slump, the uncertainty and concern of fiber laser manufacturers still exist in several years after great recession of economy. However, judging from the long-term sales, it is expected that the fiber laser is a maturing technology, and it plays an important role in the economic growth and shows a rising trend. Despite the global debt crisis will limit the investment of some equipment in 2013, the fiber laser is expected to stand out by realizing the manufacturing automation, improving efficiency, reducing energy consumption, and making the enterprise more competitive in the economic turmoil.

How to show the developing trend in detail, we take IPG Photonics company as an example and make analysis of the trend.

Fiber laser markets are mainly distributed in North America, Europe and Asia areas. According to IPG statistics, the revenues of its fiber laser were € 168.74 million, € 136.32 million and € 168.74 million between 2008 and 2010. The annual sales revenue is € 414.43 million in 2012, an increase of 19 % year-on-year. The sales revenue of materials processing product of fiber laser is an increase of 14 % year-on-year. Under the drive of the cutting and welding applications, high-power laser is an increase of 10 % year-on-year. At present, more than 1000 W of high-power laser is only offered by IPG, and the products are in short supply. (OPTOCHINA)

Therefore, with the rapid development and maturing of fiber laser technology, the features and advantages of fiber lasers have been recognized, market demand and applications are gradually increasing year by year. There is a big market opportunity.

The fiber lasers use the optical fiber as the medium of waveguide, and have the following advantages: coupling efficiency is high, it is easy to form the high power density, the cooling effect is good and without the need for large refrigeration systems, conversion efficiency is high, threshold is low, beam quality is good and flexible design, etc. It has become an important development direction of the world research the deeper laser technology. At present, the gain medium of optical fiber using the various structures and doping method and the flexible lateral multimode pumping method make the output power of fiber laser of single fiber achieve 1 kW. Its scope of application is extended from the optical communication to industrial production, national defense and military, biomedical and others. It is much accounted by governments, industry and scientific research institutions. Now it can be said that the fiber laser is one of the popular items in the field of photoelectron technology.

In future, the development trend of fiber lasers is mainly reflected in the following two aspects:

1) Fiber laser improve performance itself.

How to improve the output power and conversion efficiency, optimize the beam quality, shorten the length of the gain fiber, improve the stability of the system and make it more compact, these are the researching focus of future in the field of fiber lasers. High-performance single-wavelength and multi-wavelength fiber lasers are promising successful future in the field of optical fiber sensing and photo-communication.

2) The development of new fiber laser.

In space, the ultra-short pulse mode-locked fiber laser with a smaller space ratio has been a focus in the field of fiber lasers. High-power femtosecond fiber lasers have been researched for a long time. The breakthrough of research in this field not only provides an ideal light source for OTDM (Optical Time Division Multiplex), but also can effectively drive the laser processing, laser marking and laser encryption and the development of related industries. In frequency, the tuning fiber laser in the way of the wideband output will become a research focus. In recent years, the nonlinear fiber laser using ZEBLAN materials (Zr, Ba, La, Al, Nd) as laser medium has aroused people's attention. The kind of laser has a fairly wide broadband and low-loss, and is considered as the communication materials of next generation. The production value of fiber laser in 2003 was € 103.90 million, and up to €1.084 billion in 2008. In recent years, if fiber laser can achieve mass production, that will generate billions of dollars market in the laser printing and large-scale displayer area. (Qihong Lou p.83)

We believe that through mutual cooperation in various countries and combining with advanced science and technology, producing more high-performance and high-power fiber lasers will not be a dream any more.

8 Conclusion

Through the analysis of this article, it could be found out that fiber lasers have great advantages in technique than any other lasers. Now many countries are concerning about the progress of high-power fiber laser research and the highest power of fiber laser every year is obviously increased. Through the cooperation and attempt of all countries and every scientists, higher and higher powers will be developed. But in a short time, fiber lasers will mainly focus on high-end applications, so the cost is higher, and the fiber laser is rarely used in ordinary process and manufacture. However, with the lower costs and increased capacity in the future, the fiber lasers may eventually replace a majority of the world's high power CO₂ lasers and the YAG-laser.

References

Published document

Chen Guoliang, Research on new type Passive mode-locked fiber laser, 2008

Chen Miaohai, High power fiber laser research progress, North China photoelectric technology research laboratory, 2007.07.

Dianov E M, Fursa D G, A A, et al, Raman fiber optic amplifier of signals at the wave length of 1.3mm[J].Quantum Electron., 1994

Guo Yubin, Huo Jiayu, et al, Fiber laser and its application, Science press, 2008

Ge zhendong, Research on Novel Double Clad Fibers, East China University of science and technology press, 2009

Jiayu Huo, New technology of fiber laser, Science press, 2011, 03, 123p

Liu Shuang, Multi-wavelength fiber laser and its applied research, Huazhong University of Science and Technology press, 2010.04

Marine technology, Economic information & Agency, Hong Kong, 2013, 03, 56p

Qihong Lou, High power fiber laser, University of Science and Technology of China press, 2010, 03, 183p

Qu Yanji, Research on single pumped fiber Raman laser. Changchun University of Technology press.2010.03.01

Shen Xinzhi, Lou Shuqing, Laser principle. Tsinghua University Press. 2010

Snitzer, et al, Double clad offset core Nd fiber, proc.coaf, Optical sensors, 1988

University of Science and Technology of China, High power fiber laser and its application, University of Science and Technology of China press, 2010

Wadsworth W J, et al, Large mode area photonic crystal fibre laser[C].Conference on Lasers and Electro-Optics, 2001, 319

Xie Chunyu, Research on Q-switch double clad fiber laser, Nankai University. 2005.03

Xinzhi Sheng, Principle and technology of laser, Wuhan University press, 2011, 267p

Yang Xiufen, Jia Guoqiang, The research progress of narrow linewidth fiber laser's linewidth measurement, Tianjin Polytechnic University.2012

Yaodong Li, Fiber laser and application, Qinghua University press, 2008, 08, 326p

Yuan Shuzhong, Liu Yange, Research on photonic crystal fiber laser and supercontinuum source, Nankai University press, 2008, 04

Yunying Meng, Applications of IPG high power fiber/ laser, Xi'an electronic press, 2009, 69p

Zuo weili, Continuous ytterbium doped photonic crystal fiber laser theoretical and experimental studies, Zhen Zhou University, 2010, 52p

Network document

Binqi (Read 12.2.2013) Available: <http://www.binqitrade.com/products/CNC-LASER-Cutting-Machine.htm>

Dr.Gubo, The trend analysis of fiber laser in china (Read 25.5.2013) Available: <http://www.opticsjournal.net/OEPNNews.htm?id=PT120821000127w3z6B>

Elec & Micro technology, Basic Electronics Engineering I (Read 9.11.2011) Available: <http://www.electronics-microcontroller.com/electronics-articles-basic-Structure-of-the-Atom.htm>

Haerbin engineering university, Fiber laser 2010 (Read 2011) Available: <http://wenku.baidu.com/view/c5141e3c0912a21614792977.html>

Jianhong Liao, Fiber laser technology (Read 12.3.2012) Available: <http://www.doc88.com/p-997536945452.html>

Kamelian (Read 7.2.2013) Available: <http://www.kamelian.com/products.html>

Laserfair (Read 11.1.2013) Available: <http://www.laserfair.com/laser/gx/2011/1207/12046.html>

Machine365, Farley laserlab 3D fiber laser cutting machine (Read 13.11.2010) Available: <http://news.machine365.com/content/2010/1028/272664.html>

New maker, Wuhan Farley laserlab cutting system engineering co., LTD (Read 3.1.2013) Available: http://www.newmaker.com/pro_104636.html

Nikon (Read 21.3.2013) Available: <http://blog.nikonmetrology.com/tag/laser-radar/page/2/>

NNEEDHAM Laser, PRINT SAMPLES (Read 18.11.2012) Available: <http://www.needham-laser.com/products/fiber-laser-marking-machine/>

Nuphoton (Read 21.12.2012) Available: http://www.nuphoton.com/?page_id=169

Opticsjournal, 10000 single mode IPG fiber laser (Read 24.4.2013) Available: <http://www.opticsjournal.net/Post/Details/PT110427000064gMiPI>

OPTOCHINA, The trend analysis of fiber laser (Read 25.2.2013) Available: <http://www.optochina.net/html/zx/scfx/38797.html>

Pengcheng (Read 11.12.2012) Available: <http://peng-cheng.com/product.php?mod=detail&id=349>

Rp (Read 21.1.2013) Available: http://www.rp-photonics.com/photonic_crystal_fibers.html

Spie (Read 11.4.2013) Available: <http://spie.org/x17329.xml>

St Andrews (Read 21.11.2012) Available: <http://www.standrews.ac.uk/seeinglife/science/research/Raman/Raman.html>

Standa (Read 13.2.2013) Available: <http://microlasers.eu/laser-safety-glasses/>

Tutor Vista, Structure of an atom (Read 23.1.2013) Available:

<http://www.tutorvista.com/content/science/science-i/structure-atom/arrangement-electrons-atom.php>

Victor.R.Jones, The Interaction of Radiation and Matter: Semiclassical Theory (Read 4.11.2012)
Available: http://people.seas.harvard.edu/~jones/ap216/lectures/ls_2/ls2_u5/ls2_unit_5.htm
Weiku, Fiber laser (Read 23.4.2013), Available: <http://wiki.dzsc.com/info/5026.html>

Wiki.dzsc, Fiber laser (Read 20.4.2011) Available: <http://wiki.dzsc.com/info/5026.html>

Wuhan Sintec Optronics Co. Ltd, 10W/20W/30W/50W/100W STR Series Pulsed Fiber Laser
(Read 11.12.2012) Available: http://sintec.en.ec21.com/10W_20W_30W_50W_100W--6796745_6908498.html

