

Alexi Tanner

LTE-A 3CC Carrier Aggregation

Helsinki Metropolia University of Applied Sciences

Bachelor of Engineering

Information Technology

Thesis

10 May 2016

Author(s) Title	Aleksi Tanner LTE-A 3CC Carrier Aggregation
Number of Pages Date	45 pages + 0 appendices 10 May 2016
Degree	Bachelor of Engineering
Degree Programme	Information Technology
Specialisation option	Data Networks
Instructor(s)	Janne Salonen, Principal Lecturer Sami Virtala, Network Management Specialist
<p>The main objective of this thesis was to study and evaluate the performance of 3CC Carrier Aggregation in the commercial LTE-A network of TeliaSonera. TeliaSonera is a telecommunications provider in the Nordic and Baltic countries.</p> <p>The test measurements were performed in Finland in December 2015. The focus of this study is on the downlink throughput performance. The application and physical layer throughputs were selected for the Key Performance Indicators. Radio conditions and the success of data transmission were determined with RSRP, SNR and BLER measurements. The 3CC CA performance was compared to that of 2CC CA to point out the possible advantages that aggregating three Component Carriers offers to the end users.</p> <p>This thesis suggests that 3CC CA delivers a better mobile broadband experience to the end user by enhancing the peak and average data rates. The theoretical peak data rates were not reached, however the performance of 3CC CA in the operator's live network were encouraging.</p>	
Keywords	3CC CA, 3CC, CA, Carrier Aggregation, LTE-A, TeliaSonera

Tekijä(t) Otsikko	Aleksi Tanner LTE-A 3CC Carrier Aggregation
Sivumäärä Aika	45 sivua + 0 liitettä 10.5.2016
Tutkinto	Insinööri (AMK)
Koulutusohjelma	Tietotekniikka
Suuntautumisvaihtoehto	Tietoverkot
Ohjaaja(t)	Janne Salonen, Yliopettaja Sami Virtala, Network Management Specialist
<p>Insinööriyön tavoite oli tutkia ja arvioida kolmen kantaallon yhdistämistekniikan suorituskykyä TeliaSoneran kaupallisessa LTE-A verkossa. TeliaSonera on Pohjoismaissa ja Baltiassa toimiva teleoperaattori.</p> <p>Testimittaukset suoritettiin Suomessa joulukuun 2015 aikana. Insinööriyössä keskitytään tutkimaan alalinkin nopeutta ja suoritustehoa. Sovellus ja fyysisen kerroksen suoritustehot valittiin mittaamaan suorituskykyä. Radio-olosuhteet ja tiedonsiirron onnistuminen on määritelty RSRP, SNR ja BLER -mittauksilla. Kolmen kantaallon yhdistämistekniikkaa verrattiin kahden kantaallon yhdistämistekniikkaan, jotta loppukäyttäjän kokemat mahdolliset hyödyt kolmen kantaallon yhdistämistekniikasta saatiin selville.</p> <p>Insinööriyö osoittaa, että kolmen kantaallon yhdistämistekniikka mahdollistaa loppukäyttäjälle paremman mobiililaajakaistakokemuksen parantamalla huippu- ja keskiverto tiedonsiirtonopeuksia. Mittauksissa ei saavutettu teoreettisia huippunopeuksia, mutta kolmen kantaallon yhdistämistekniikan suorituskyky operaattorin kaupallisessa verkossa oli suuntaa antava.</p>	
Avainsanat	3CC CA, 3CC, CA, Carrier Aggregation, LTE-A, TeliaSonera

Contents

List of Abbreviations

1	Introduction	1
2	LTE	2
2.1	Evolved Packet System	2
2.1.1	User Equipment	3
2.1.2	E-UTRAN and eNodeB	4
2.1.3	Mobility Management Entity and Home Subscription Server	4
2.1.4	Serving Gateway and Packet Data Network Gateway	5
2.2	Technology in LTE	5
2.2.1	Multiple Access Schemes	5
2.2.2	MIMO	6
2.2.3	Modulation Schemes	7
2.3	LTE Radio Protocols and Channels	8
3	LTE-Advanced and LTE-Advanced Pro	11
3.1	Releases and Features	11
3.1.1	Advanced MIMO Schemes	12
3.1.2	Coordinated Multipoint	13
3.1.3	Relay Nodes	14
3.1.4	Heterogeneous Deployments and Small Cells	15
3.2	LTE-Advanced Pro	16
4	Carrier Aggregation	17
4.1	Basics of Carrier Aggregation	17
4.2	Carrier Aggregation Scenarios	18
4.2.1	Carrier Aggregation Modes	18
4.2.2	Carrier Aggregation Deployment Scenarios	20
4.2.3	Band Combinations	21

4.3	Cell and Mobility Management	23
4.4	UE Capabilities and Theoretical Expectations	23
4.5	Future Enhancements and Development	25
5	Research Material and Methods	26
5.1	Test and Processing Tools	26
5.2	Measurement Setup	26
5.3	KPIs Used in Measurements	27
6	Performance Measurements	29
6.1	3CC CA Measurements	29
6.1.1	Application Layer Throughput	29
6.1.2	Physical Layer Throughput	30
6.1.3	RSRP and SNR	31
6.1.4	BLER	33
6.2	2CC CA Measurements	34
6.2.1	Application Layer Throughput	34
6.2.2	Physical Layer Throughput	35
6.2.3	RSRP and SNR	35
6.2.4	BLER	37
7	Performance Evaluation	38
8	Discussion and Conclusions	41
	References	43

List of Abbreviations

2CC CA	<i>Two Carrier Aggregation</i> , the aggregation of two component carriers
3CC CA	<i>Three Carrier Aggregation</i> , the aggregation of three component carriers
3GPP	<i>Third Generation Partnership Project</i> , a collaboration of telecommunications development organizations that define 3GPP technologies
64-QAM	<i>64 Quadrature Amplitude Modulation</i> , a digital modulation technique
256-QAM	<i>256 Quadrature Amplitude Modulation</i> , an advanced digital modulation technique
ARQ	<i>Automatic Repeat Request</i> , a method for repetition of erroneous packets in <i>RLC</i> layer
BLER	<i>Block Error Ratio</i> , the ratio of erroneous blocks received to the total number of blocks sent
BPSK	<i>Binary Phase Shift Key</i> , a robust digital modulation technique
CA	<i>Carrier aggregation</i> , a technique used in <i>LTE-A</i> to increase bandwidth
CC	<i>Component Carrier</i> , an individual carrier used in <i>CA</i>
CoMP	<i>Coordinated Multi-point transmission and reception</i> , a technique used in <i>LTE-A</i> to ensure optimum performance
CQI	<i>Channel Quality Indicator</i> , an indication carrying information about the communication channel quality

CS	<i>Circuit-Switched</i> , a legacy technique used to form communication networks
DL	<i>Downlink</i> , a communication link from <i>eNodeB</i> to device
DRX	<i>Discontinuous Reception</i> , a technique used in <i>LTE</i> to extend battery lifetime of an <i>UE</i>
E-UTRAN	<i>Evolved Universal Terrestrial Radio Access Network</i> , the access part of the <i>EPS</i> consisted of <i>eNodeBs</i>
eNodeB	<i>Evolved Node B</i> , a macro base station in <i>LTE</i>
EPC	<i>Evolved Packet Core</i> , the core network in <i>LTE</i>
EPS	<i>Evolved Packet System</i> , a system which includes <i>E-UTRAN</i> and <i>EPC</i>
FD-MIMO	<i>Full Dimension MIMO</i> , an enhanced <i>MIMO</i> technique
HARQ	<i>Hybrid Automatic Repeat Request</i> , a method for error correction in physical layer
HSPA	<i>High Speed Packet Access</i> , a standard for wireless telecommunication
HSS	<i>Home Subscription Server</i> , a server which manages subscription related information
IMS	<i>IP Multimedia Subsystem</i> , an architecture used for delivering services in <i>LTE</i>
IMT-Advanced	<i>International Mobile Telecommunications Advanced</i> , the requirements for <i>4G</i> set by <i>ITU</i>
IoT	<i>Internet of Things</i> , a network of physical object connected to collect and exchange data

ITU	<i>International Telecommunication Union</i> , a United Nations agency for <i>ICT</i>
KPI	<i>Key Performance Indicator</i> , a measurable value to evaluate performance
LTE	<i>Long Term Evolution</i> , a fourth generation wireless technology developed by <i>3GPP</i>
LTE-A	<i>Long Term Evolution – Advanced</i> , an enhancement of <i>LTE</i>
MAC	<i>Medium Access Control</i> , a protocol layer in <i>LTE</i>
MIMO	<i>Multiple Input Multiple Output</i> , a multiple antenna technique used to improve performance
MME	<i>Mobility Management Entity</i> , the main signaling node in <i>EPC</i>
NAS	<i>Non-access Stratum</i> , a set of protocols in the <i>EPS</i>
NodeB	<i>NodeB</i> , a macro base station in previous generation networks
OFDMA	<i>Orthogonal Frequency Division Multiple Access</i> , a multiple access scheme used in <i>LTE</i> for <i>DL</i>
P-GW	<i>Packet Data Network Gateway</i> , a gateway between the UE and the services existing in external <i>PDNs</i>
PCC	<i>Primary Component Carrier</i> , the main <i>CC</i> used in <i>CA</i>
PCell	<i>Primary Cell</i> , the main cell used in <i>CA</i>
PCRF	<i>Policy and Charging Resource Function</i> , a network node responsible of policy and charging functions
PDCCP	<i>Packet Data Convergence Protocol</i> , a protocol layer in <i>LTE</i>

PDN	<i>Packet Data Network</i> , an external <i>IP</i> network
PDSCH	<i>Physical Downlink Shared Channel</i> , the channel in physical layer for sending data to users
PHY	<i>Physical Layer</i> , a protocol layer in <i>LTE</i>
PS	<i>Packet-Switched</i> , a packet based technique used to form communication networks
QoS	Quality of Service, a definition to prioritize subscribers in <i>LTE</i>
QPSK	<i>Quadrature Phase Shift Keying</i> , a digital modulation scheme
RAN	<i>Radio Access Network</i> , a technology used to connect devices to core network in <i>LTE</i>
RF	<i>Radio Frequency</i> , a set of frequencies used in telecommunications
RLC	<i>Radio-Link Control</i> , a protocol layer in <i>LTE</i>
RN	<i>Relay Node</i> , a node used in <i>LTE</i> networks to enhance coverage
RRC	<i>Radio Resource Control</i> , a protocol layer in <i>LTE</i>
RRH	<i>Radio Remote Head</i> , a component used to extend coverage in wireless networks
RSRP	<i>Reference Signal Received Power</i> , a parameter used to define radio conditions and cell selection
RNC	<i>Radio Network Controller</i> , an intelligent controller node in previous generation core networks

S1	<i>S1-interface</i> , the interface between <i>eNodeB</i> and the Evolved Packet Core
S11	<i>S11-interface</i> , the interface between <i>MME</i> and <i>S-GW</i>
S-GW	<i>Serving Gateway</i> , a gateway for routing data packets
SC-FDMA	<i>Single Carrier Frequency Division Multiple Access</i> , a multiple access scheme used in <i>LTE</i> for <i>UL</i>
SCC	<i>Secondary Component Carrier</i> , the secondary component carrier used in <i>CA</i>
SCell	<i>Secondary Cell</i> , the secondary serving cell in <i>CA</i>
SNR	<i>Signal-to-noise ratio</i> , a measure used to compare the signal to background noise
TA	<i>Tracking Area</i> , an area used for tracking <i>UE</i> location
UE	<i>User Equipment</i> , an end user device, for example a smart phone
UICC	<i>Universal Integrated Circuit Card</i> , a new generation <i>SIM</i> -card used to identify subscription and store information
UL	<i>Uplink</i> , a communication link from device to <i>eNodeB</i>
USIM	<i>Universal Subscriber Identity Module</i> , an application run by <i>UICC</i>
VoIP	<i>Voice over IP</i> , a technique to enable voice services over <i>IP</i>
X2	<i>X2-interface</i> , the interface between <i>eNodeBs</i>

1 Introduction

During the past 15 years, mobile technology has increased immensely: worldwide mobile subscriptions hit from one to seven billion between 2002 and 2014 [1]. At present, a growing number of mobile devices are connected to the internet and therefore the mobile data traffic has been expanding tremendously. Furthermore, it is expected that between 2015 and 2021 the global mobile traffic will increase eleven-fold and that approximately 90% of mobile data traffic will be from smartphones by the end of 2021 [2, p. 12].

Because the mobile broadband is no longer an expensive technology, it has become an everyday necessity as end users have found use for mobile broadband with services such as Spotify, Netflix and WhatsApp. For example, in 2015, the average monthly data consumption of the Finnish operator Elisa mobile network users was already six Gigabytes [3]. The increasing data consumption per subscriber and the number of smartphone subscriptions have created a demand for faster networks, and for many operators the Long Term Evolution (LTE) Release 8 and 9 networks have been the solution so far. With the forecast of eleven-fold growth and customer needs becoming more demanding, more advanced technology is needed.

One of the answers to the high and increasing requirements from the radio networks in the future is the LTE-Advanced (LTE-A) with the Carrier Aggregation (CA). The LTE-A is an enhancement for LTE and includes features such as Carrier Aggregation, Heterogeneous Networks and enhanced Multiple Input Multiple Output (MIMO) techniques. Carrier Aggregation combines multiple component carriers and allows overall wider bandwidth, improved downlink coverage and higher throughput compared to the Release 8 LTE. This makes CA one of the most promising technology components in the LTE-A.

This thesis was commissioned by TeliaSonera and it focuses on 3 Component Carrier Carrier Aggregation (3CC CA). The main objective of this thesis is to study the 3CC CA and examine whether the performance matches with theoretical expectations, for example in terms of throughput. In addition, the aim is to compare LTE-A 3CC CA with 2CC CA and study the possible advantages the 3CC CA provides.

2 LTE

In 2004, the Third Generation Partnership Project (3GPP) started to define targets for LTE. It was obvious that a new and evolved radio technology should be standardized for the increasing mobile broadband usage and more demanding end user needs. The LTE standard was approved in 2007 and the first commercial LTE networks were deployed in 2010. [4, p. 4-6.]

The scope of the 3GPPs Study Item for the long-term evolution of radio-access technology was to ensure competitiveness for the next ten years. The 3GPP requirements for the LTE are high spectral efficiency, high peak data rates, improved LTE access setup time, high level of mobility and security, optimized terminal power efficiency and flexibility in frequency and bandwidth. Peak data rates are defined to exceed 100 Mbps in the downlink (DL) and 50 Mbps in the uplink (UL). The round trip time is defined to be less than 10 ms, which improves the access setup time. [5.]

Compared to the High Speed Packet Access (HSPA) Release 6, the peak user throughput of the LTE Rel. 8 is ten times higher and latency two or three times smaller. Latency is reduced in LTE by reducing the amount of network elements. To be able to achieve these requirements, both the radio network architecture and the radio-access technology needed to evolve.

In the 3GPP Release 6, radio protocols, mobility management, header compression and packet retransmissions are handled in Radio Network Controller (RNC), but in LTE, these are located in the evolved NodeB (eNodeB). Thus, LTE access network is simplified and no separate intelligent controller is needed. ENodeBs are connected with each other using the X2-interface, and towards the Evolved Packet Core (EPC) using the S1-interface. [4, p. 23-35; 6.]

2.1 Evolved Packet System

The architecture of the Evolved Packet System (EPS) consists of three main components, which are the User Equipment (UE), the Evolved Universal Terrestrial Radio Access Network (E-UTRAN) and the EPC. Figure 1 illustrates the system architecture in LTE.

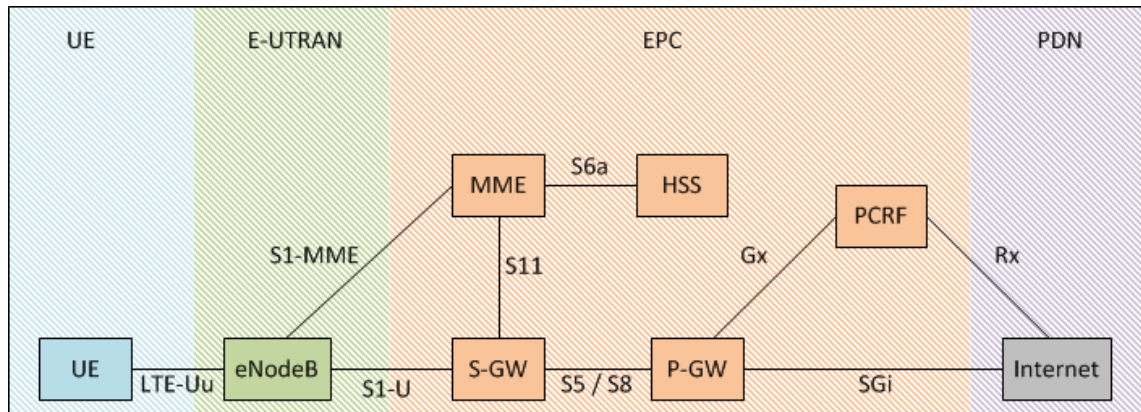

Figure 1. EPS basic architecture [4, p. 25].

The EPC contains the following network elements: Mobility Management Entity (MME), Serving Gateway (S-GW) and Packet Data Network Gateway (P-GW). The number of network elements in the EPC is reduced compared to the previous generation architectures, and the Radio Access Network (RAN) functionality is also provided by a single node. Unlike in previous generation systems, there is no need for direct connection to the circuit-switched (CS) services in LTE as it is a packet-switched (PS) only technology and optimized for IP based connectivity. The EPS bearer is introduced in EPS, which defines where the IP traffic is routed between the UE and the packet data network. [7, p. 16-18.]

Voice calls are still possible in LTE using CS fallback, in which case the mobile is transferred to a legacy generation network and is thereby connected to the CS domain. Another way is to use IP Multimedia Subsystem (IMS), which is an external network and provides services on top of the IP — in this case Voice over IP (VoIP). [4, p. 23-35.] The components of EPS are introduced and some of the main functions described below.

2.1.1 User Equipment

The User Equipment is typically a smart phone, tablet or a laptop that contains a Universal Integrated Circuit Card (UICC), also known as SIM card. The UICC runs an application called Universal Subscriber Identity Module (USIM), which contains user-specific information such as the phone number, home network identity and security keys. UE is instructed by the network to perform mobility management operations, such as handovers and location updates. UEs are grouped by the UE Category, which

covers the maximum data rates that the mobile can transmit and receive; for example, the Category 12 UE can achieve data rates of 600 Mbps in the DL and 100 Mbps in the UL. [8, p. 21-26.]

2.1.2 E-UTRAN and eNodeB

The radio communications between the EPC and the UE are handled in E-UTRAN by its only component, the eNodeB. LTE RAN consists of eNodeBs, which are connected to each other using the X2-interface. Simply put, the eNodeB is a base station that sends radio transmission on the DL and receives transmission on the UL from the UEs it serves.

Based on the radio signal level measurements, which UE measures and reports, the eNodeB also instructs the UE to perform operations such as handovers. Radio Resource Management, which includes traffic prioritizing and resource allocating, is also handled by the eNodeB. [4, p. 27-35.]

2.1.3 Mobility Management Entity and Home Subscription Server

The MME is the control-plane element in EPC and with UE it provides a direct connection known as the Non-access Stratum (NAS). NAS signaling includes authentication when UE connects to the network. The MME functions include mobility management, authentication and security for E-UTRAN access. MME is responsible for setting up and releasing of resources upon UE activity mode changes and is involved in handovers between eNodeBs, S-GWs and MMEs.

MME keeps track of UEs location in the service area by periodical location updates from the UE or when the UE moves to another Tracking Area (TA). MME also retrieves and stores subscriber profile information for the time it is serving the UE and the profile determines which Packet Data Network (PDN) connections are allocated for the UE. Each UE is only connected to a single MME, but one MME typically serves multiple eNodeBs at the same time. [4, p. 27-35.] The Home Subscription Server (HSS) is a database that contains user and subscription related data and is connected to the MME [9].

2.1.4 Serving Gateway and Packet Data Network Gateway

As MME handles the control-plane, gateways handle the user-plane. The S-GW is directly connected to the E-UTRAN. The S-GW routes and forwards UEs data packets and acts as a mobility anchor during eNodeB handovers and other 3GPP technologies by relaying the traffic between 2G and 3G systems.

The P-GW connects the EPC to external packet data networks such as the internet or the IMS and allocates IP address to the UE. The P-GW is connected to Policy and Charging Resource Function (PCRF), which handles the policy and charging control in the EPC, defines Quality of Service (QoS) profiles for the UE, and provides the information to P-GW [4, p. 27-35; 9].

2.2 Technology in LTE

Multiple access schemes, MIMO and modulation are the three key technologies that enable the high performance of LTE networks. Orthogonal Frequency Division Multiple Access (OFDMA) and Single Carrier Frequency Division Multiple Access (SC-FDMA) were selected for the multiple access schemes in LTE; OFDMA for the DL and SC-FDMA for the UL. These technologies are also used in LTE-A.

2.2.1 Multiple Access Schemes

By sharing the resources of the air interface, multiple access techniques allow base stations to communicate with multiple UEs simultaneously. [8, p. 67.] OFDMA multiple access means that the bandwidth is divided into a subcarriers orthogonally without interfering each other, and the subcarriers can be shared between users. This enables efficient use of the available bandwidth [4, p.68-69]. SC-FDMA generates the signal with single carrier characteristics and the data transmission remains serial, unlike in the downlink in which it is parallel, one per sub-carrier [6].This is illustrated in Figure 2.

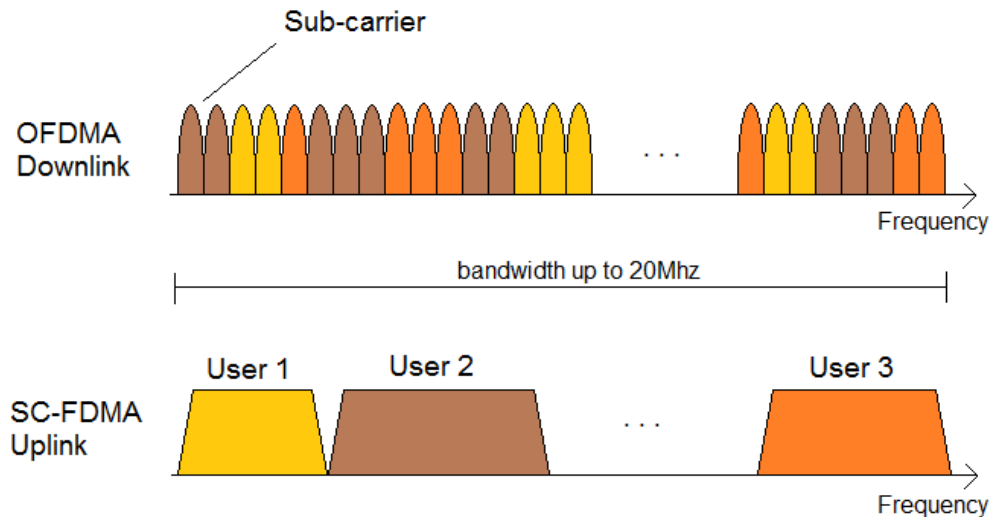

Figure 2. Frequency domain presentation of downlink and uplink in LTE access technologies [6].

In OFDMA, the bandwidth is divided into orthogonal narrowband subcarriers as illustrated in Figure 2. The use of OFDMA causes power consumption to increase because it requires power amplifiers. In eNodeB these power amplifiers are easy to implement. Due to these capabilities SC-FDMA was selected for the UL access scheme and OFDMA for the DL access scheme. In UL direction, SC-FDMA generates a signal with single carrier characteristics, which the UE can manage power efficiently without expensive amplifiers. [6].

2.2.2 MIMO

MIMO is a multiple antenna technique. In LTE, MIMO enables the base station and mobile to use multiple antennas for radio transmission and reception. It is often referred as spatial multiplexing, meaning that signals are transmitted from multiple antennas with different data streams to multiple receiver antennas. Spatial multiplexing does not necessarily make the transmission more robust, but it increases the data rate compared to using single antennas for receiving or transmitting. [10.]

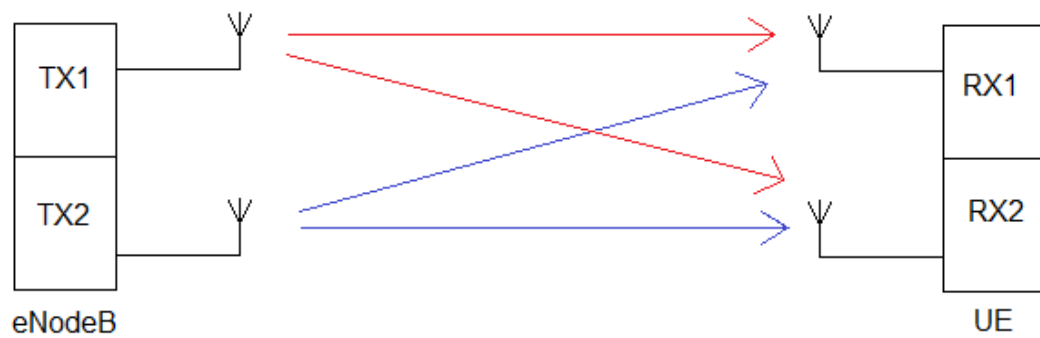

Figure 3. Spatial Multiplexing 2x2 MIMO [10].

In Figure 3 above, 2x2 spatial multiplexing MIMO between eNodeB and UE is illustrated. The eNodeB transmits two individual data streams from two TX antennas to the UE, which has two RX receiver antennas. Also, there are different MIMO modes available, one of them being Transmit diversity. Transmit diversity is a MIMO mode, where the same signal is sent from multiple antennas rather than with different data streams, as in spatial multiplexing.

2.2.3 Modulation Schemes

Another factor related to higher data rates is modulation. Modulation provides higher data rates within the given transmission bandwidth as it includes additional signaling alternatives. However, higher bandwidth utilization using modulation reduces robustness, which exposes the signal to noise and interference. [11, p. 21-22.] The use of higher modulation schemes require excellent signal-to-noise ratio (SNR), which is often achieved when the UE is near the eNodeB.

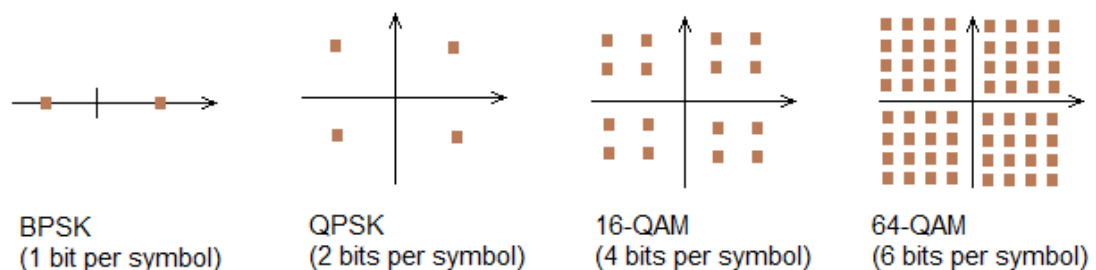

Figure 4. Modulation schemes used in LTE [8, p. 51].

In LTE modulation, the amplitude and the initial phase parameters are adjusted to allow more bits to be sent per modulation symbol. LTE uses four different modulation schemes, the most efficient being 64 Quadrature Amplitude Modulation (64-QAM). It sends six bits at a time using 64 symbols which have different amplitudes and phases. Compared to Binary Phase Shift Key (BPSK), which sends one bit at a time, 64-QAM has a six times greater data rate. [8, p. 49-53.] This is illustrated in the Figure 4.

2.3 LTE Radio Protocols and Channels

The LTE radio interface protocol architecture is illustrated in Figure 5 and the protocol layers and radio channels are explained below. The user-plane transports the information considered as user data, whereas control-plane transports the information considered as signaling messages. Control messages for handover, paging and bearer management are examples of signaling messages.

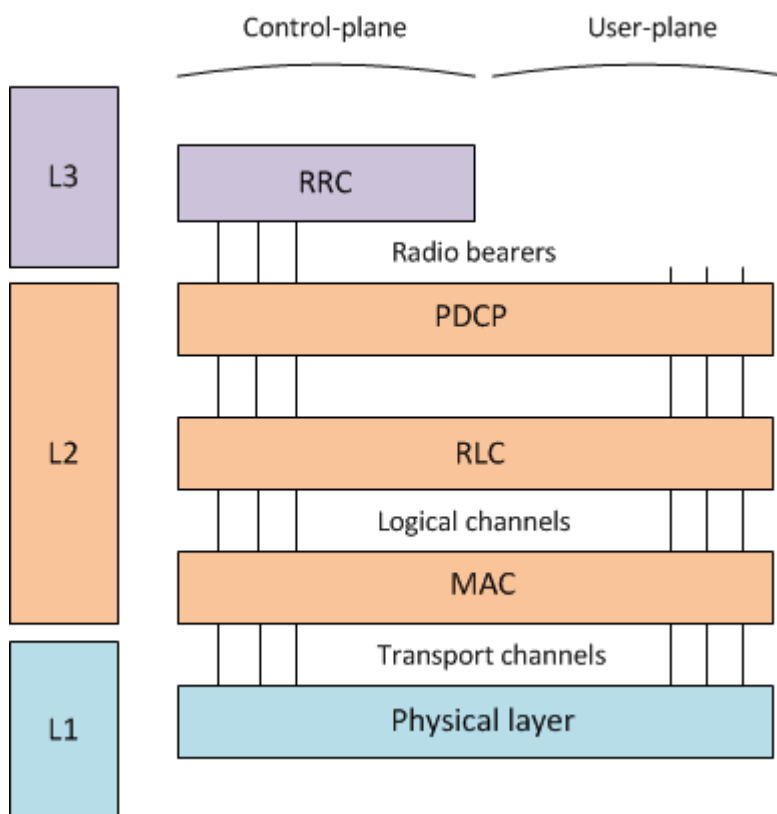

Figure 5. LTE radio protocol stacks for control-plane and user-plane [4, p. 142].

The first protocol layer is the Radio Resource Control (RRC) layer, which supports the signaling between the UE and the eNodeB. The RRC messages are a major part of control information between UE and E-UTRAN, as RRC protocol is in control of the radio resource usage. The main functions include mobility, paging and the following RRC connection procedures: establishment, maintenance and release of RRC connection between the UE and E-UTRAN. The UE can be in two states depending on the RRC connection. If the UE is in RRC_IDLE state, it monitors a paging channel for incoming calls and acquisition of system information and performs cell measurements. However, if the UE is in RRC_CONNECTED state, it transfers or receives data from the network. The UE monitors the control channels for scheduled data transmissions. [4, p. 151-153.]

The second layer, the Packet Data Convergence Protocol (PDCP) layer covers header compression, ciphering and integrity protection. The header compression reduces the number of bits transmitted over the radio interface and is important for smaller packets in question because capacity is not wasted. [4, p. 150.]

The third layer is the Radio-Link Control (RLC) layer and its functions include duplicate detection, packet data segmentation and Automatic Repeat Request (ARQ), which is a mechanism for error correction. The RLC provides services to the PDCP. [4, p. 147-148.]

The fourth layer is the Medium Access Control (MAC) layer, which maps and multiplexes the logical channels to the transport channels. Key functionalities of MAC layer include traffic volume measurement reporting, priority handling between logical channels and error correction. Error correction is managed through Hybrid Automatic Repeat Request (HARQ) in order to control physical layer retransmission handling together with scheduling. The MAC layer provides the RLC logical channel services. [4, p. 144.]

Lastly, the Physical (PHY) layer handles the channel coding, modulation and antenna mapping before transmission over the radio interface. The PHY layer provides data transport services to the RLC and MAC layers on physical channels. [4, p. 141.]

There are three different radio channel types in LTE: the logical channels, the transport channels and the physical channels. The logical channels are a type of radio channels,

which indicate what is being transmitted. There are two types of logical channels: the control channels, which transfer the control plane information and the traffic channels, which transfer the user plane information. The transport channels define how and with what characteristics data is being transmitted. As an example, the transport channels handle the protection of data against errors in transmission. Physical channels are the actual implementations of the transport channels where data is being transmitted over the air interface. [11, p. 128-132.]

3 LTE-Advanced and LTE-Advanced Pro

Compared to the previous generation technologies, LTE Release 8 introduced several enhancements, for example OFDMA/SC-FDMA air interface technology, support of 20 MHz bandwidth, MIMO and advanced modulation. Nonetheless, further enhancements were needed as the mobile broadband traffic continued to grow.

With the intention to provide higher bitrates and completely fulfill the requirements for International Mobile Telecommunications Advanced (IMT-Advanced) set by the International Telecommunication Union (ITU), LTE was developed towards LTE-Advanced with LTE Release 10 in 2011. LTE-A introduced new features on top of the existing LTE technologies and is fully backwards compatible with the earlier LTE releases. This means that legacy devices are capable of operating in LTE-A networks, but may not benefit from all the new features. The first commercial LTE-A networks were launched in Korea during summer 2013. [12; 13.]

3.1 Releases and Features

The LTE Release 10 further improved the capabilities of LTE Release 8 and 9, and was developed to match the ITU requirements for IMT-Advanced. LTE Release 10 is more commonly known as LTE-Advanced. Release 10 includes features such as Carrier Aggregation, Advanced MIMO and Relay Nodes. One of the most significant features in LTE-A is Carrier Aggregation, which allows operators to deploy bands larger than 20 MHz.

The LTE Release 11 includes Carrier Aggregation enhancements, CoMP transmission and reception, and enhanced heterogeneous deployments. [11, p. 103-104.] The LTE Release 12 introduced the use of LTE for emergency and security services, Small Cell enhancements and 256-QAM modulation scheme [14].

Release 13 includes additional bands for LTE, more inter-band and intra-band combinations for CA and advanced modulation [15]. Work on the LTE Release 14 has already started. There are over thirty studies in the release, and the focus points are Mission Critical enhancements, four band CA and inter-band CA. [16].

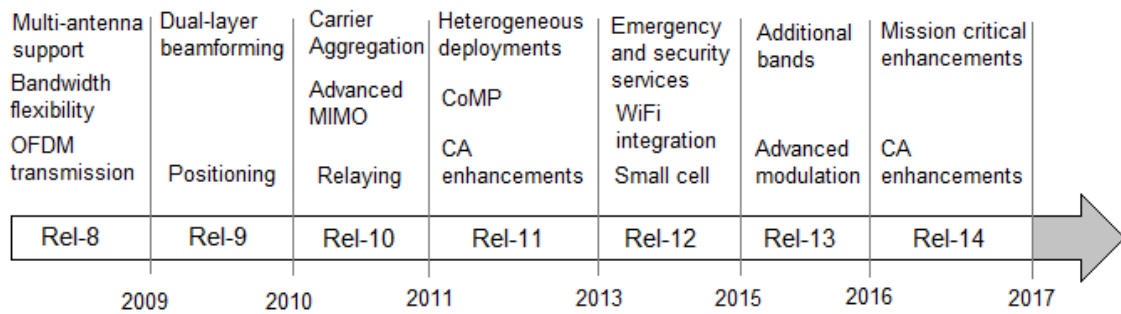

Figure 6. LTE releases and some of the features illustrated in a timeline [11, p. 103-104; 17].

Figure 6 illustrates the release timeline and some of the most important features and enhancements of the LTE Releases 8 to 14. Some of the most impactful features of LTE-A are introduced in the next chapter. Carrier Aggregation is introduced in Chapter 4.

3.1.1 Advanced MIMO Schemes

MIMO support has been enabled since the LTE Release 8, but LTE-A has advanced MIMO schemes as an enhancement. MIMO is based on transmitting and receiving using multiple antennas, and utilizing communication channels which are uncorrelated. The multiple transmissions can share the same frequency resources and if the system can utilize the communication channels efficiently for multiple transmission, the system is capable of providing higher capacity.

There are various subjects regarding MIMO performance. One of them is the number of antennas in the transmitter and in the receiver. The LTE Releases 8 and 9 allow the use of four transmitter and receiver antennas in the DL, but only a single antenna in the UL. In Release 10, this is enhanced by supporting up to four transmitter and eight receiver antennas in the UL. Downlink supports eight transmitter and receiver antennas. Release 10 also introduced new reference symbol design, which enables better performance if the number of antenna branches is high. Higher peak data rate is achieved by enabling more parallel transmission streams. For example, with 20 MHz carrier 150 Mbps is achieved with 2x2 MIMO. Theoretically 600 Mbps can be achieved with 8x8 MIMO. [13.]

LTE Release 13 introduces 3-D beamforming, which is also known as Full Dimensional MIMO (FD-MIMO). Beamforming means that multiple antennas can provide better coverage to specific areas by controlling and steering the signal. The amount of antenna arrays is increased up to 16 ports and Release 14 will allow the use of 64 ports. This will enable the exploitation of elevation domain as in previous releases the focus has only been in azimuth domain. [18.]

3.1.2 Coordinated Multipoint

The received signal from the serving cell is much weaker if the UE moves further away from the base station. If there are other cells nearby, the UE will receive inter-cell interference from them. This would reduce the data rate and as a result, user would have degraded performance near the edge of a cell.

CoMP is a technique that enables the nearby antennas to cooperate, reduce the interference and improve the average cell efficiency for cell-edge users. Cooperation allows the sharing of user data, scheduling information and channel quality. [8, p. 333-337.] The term point is defined by 3GPP specification as a set of geographically co-located transmit antennas.

CoMP improves the performance of a network near the edge of a cell by assigning points that provide coordinated transmission and reception. The points may belong either to the same or to a different eNodeB and provide coverage to different sectors, thus allowing operators to utilize network resources efficiently.

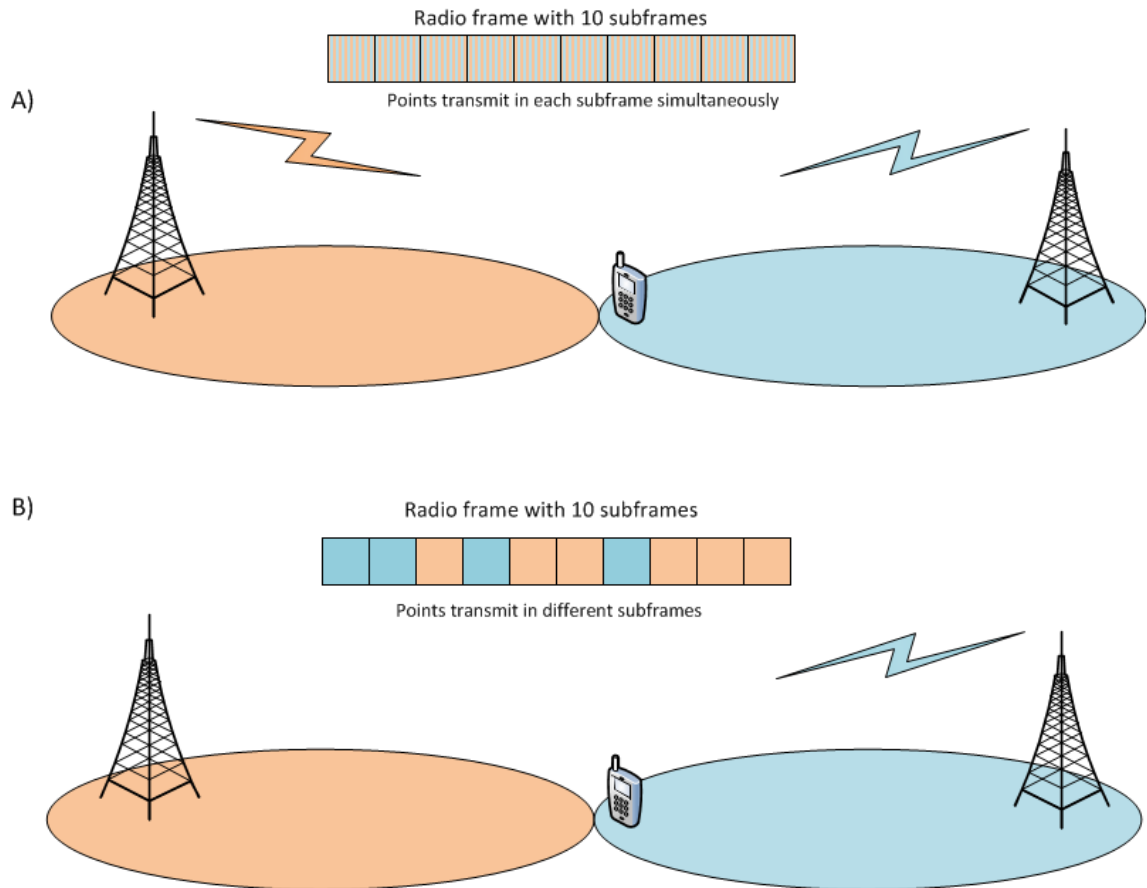

Figure 7. Downlink CoMP A) Joint transmission where two points transmit to one UE with same resource. B) Dynamic point selection where two points are available for transmit, but transmission is scheduled for only one point in each subframe [12].

CoMP can be implemented in several ways, for example by joint transmission or dynamic point selection. Joint transmission means that the data transmission to UE is simultaneous from multiple points, which improves the quality of received signal and data throughput. Dynamic point selection schedules the data transmission to be sent from one point rather than transmitting simultaneously. [19.] These two methods are illustrated in Figure 7.

3.1.3 Relay Nodes

Repeaters have been supported in LTE since Release 8. Repeaters amplify and forward the received signal and are commonly used by operators as a solution for improving coverage. Repeaters are a suitable solution in areas where the network

performance is limited by coverage instead of capacity. The downside is that repeater amplifies the received signal as well as the incoming noise and interference, which affects and limits its performance.

Solution for the dilemma was introduced in LTE Release 10 in the form of Relay Nodes. Relay decodes the received signal and then re-encodes it before forwarding. This process removes the noise and interference from the retransmitted signal rather than amplifying it like repeater does. Thus, use of Relay Nodes enable higher performance than repeaters. Relay Node is connected to donor eNodeB using backhaul link and to the terminal using access link. This means that Relay Node communicates with donor eNodeB as well as the terminals. Relay is basically an eNodeB connected to the RAN via LTE radio interface. Relay Nodes are transparent to the UE, which means that UE should not be aware if it is connected using a Relay or a normal base station. [11, p. 413-415.]

3.1.4 Heterogeneous Deployments and Small Cells

As the mobile data traffic and the amount of connected devices in the mobile network have been increasing, so have the expectations of customers towards the network capabilities. Consumers use more and more cloud-based services, video streaming and different applications, and require high quality mobile broadband experience everywhere. One solution for delivering high quality mobile broadband experience is Heterogeneous networks.

Heterogeneous network basically means that different radio technologies and cell types work together to provide better capacity, coverage and throughput. Current mobile networks are usually deployed as homogeneous networks, which means that macro base stations are located and planned carefully with similar transmit power levels and connectivity to the packet data network.

In dense urban areas, site acquisition has become increasingly difficult and macro base stations harder to deploy. In heterogeneous network Small Cells, WiFi integration and Relay Nodes can be added to operator network together with existing macro cells to either improve capacity in hot spots or to eliminate coverage holes cost efficiently. Site acquisition can be easier for Small Cells and Relay Nodes because of their smaller size and lower transmit power compared to macro base stations. [20.] For example, in

2016, the Dutch operator Tele2 implemented Nokia Networks Flexi Zone solution at their flagship store in Amsterdam. Tele2 is also planning to deploy Small Cells in outdoor hot spots and key indoor locations for better user experience [21].

3.2 LTE-Advanced Pro

In February 2016, a subsidiary company of TeliaSonera, Omnitel demonstrated a data download speed of nearly 700 Mbps in a live network using LTE-A Pro technology. However, commercially available devices are currently not capable of benefitting from this technology. [22]. As LTE Release 10 is also known as LTE-Advanced, 3GPP Release 13 and the releases after Rel. 13 are also known as LTE-Advanced Pro. The term Pro is intended to be a marker for further evolution of LTE. These releases further improve the radio performance and enable more efficient use of mobile broadband, for example by the optimization of Internet of Things (IoT).

IoT optimization in Release 13 extends the coverage for power-limited devices and improves the battery consumption by introducing Discontinuous Reception (DRX). LTE-A Pro also enhances CA by enabling up to 32 component carriers. MIMO is enhanced by enabling up to 16 or 64 transceivers at the base station end. These enhancements have a considerable effect on the overall data rates. Latency is also reduced significantly compared to LTE Release 8 and Release 10. Low latency has a great impact on user experience and it also opens up new use cases, in which the low delay is necessary. The current LTE networks have been operating in licensed spectrum between 450 and 3600 MHz, but LTE-A Pro allows the use of unlicensed bands such as 5 GHz, which is especially suitable for Small Cells. [23].

Release 14 started the work towards 5G in 3GPP. 5G will consist of LTE evolution and a new radio-access technology. The new radio-access technology will focus on new spectrum where LTE is not deployed. LTE evolution will focus on backwards-compatibility enhancements in existing spectrum. [24.] The estimated end date for LTE Release 14 is in September 2017 [17].

4 Carrier Aggregation

Carrier Aggregation was introduced in LTE Release 10 and it has been enhanced in the later releases. CA is considered to be the most important feature of LTE-A because it offers higher data rates, improves the DL coverage and allows operators with fragmented spectrum to utilize spectrum resources more effectively. The first commercial LTE Rel. 10 network was launched in Korea in 2013 and since then the rollout has been continuing worldwide. In September 2015, TeliaSonera achieved data speeds of 375 Mbps on live LTE network in Helsinki using three-band CA technology [25]. Three-band Carrier Aggregation technology was enabled in LTE Release 12.

4.1 Basics of Carrier Aggregation

LTE Rel. 8 carrier uses a maximum bandwidth of 20 MHz and with Spatial Multiplexing is theoretically able to achieve peak data rates of 300 Mbps in the DL and 75 Mbps in the UL. In order to increase the data rates, bandwidths wider than 20 MHz must be enabled. The solution to this is Carrier Aggregation.

Carrier Aggregation allows the combining of LTE carriers and enables the maximum bandwidth of 100 MHz. Aggregated carrier is referred as a component carrier (CC) and a CC can have a channel bandwidth of 1.4, 3, 5, 10, 15 or 20 MHz. For example, if five 20 MHz CCs are aggregated, the maximum aggregated bandwidth is 100 MHz. Each CC can be of different bandwidths, but a maximum of five CCs can be aggregated, and the entire set of aggregated carriers can be considered as a single carrier. [26.]

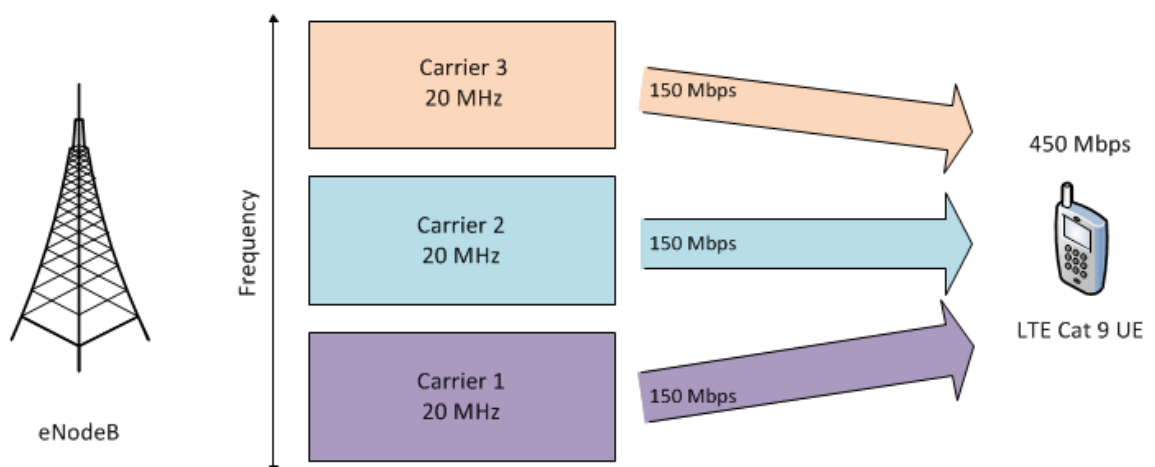

Figure 8. CA with three 20 MHz carriers. UE is LTE Cat. 9 device and is in theory capable of achieving 450 Mbps in the downlink. [27.]

Early implementations of Carrier Aggregation enabled the use of two CCs, thus allowing the maximum aggregated bandwidth of 40 MHz. LTE Rel. 12 enabled the use of three aggregated carriers and overall bandwidth of 60 MHz. [26.] Figure 8 illustrates the three carrier CA. The eNodeB aggregates three 20 MHz carriers using CA and Category 9 UE is able to achieve peak data rate of 450 Mbps in the DL.

4.2 Carrier Aggregation Scenarios

In general, there are three modes of Carrier Aggregation [8, p. 313-314]. Operators are able to exploit fragmented spectrum allocations because in CA, component carriers do not have to be contiguous in frequency. Carrier Aggregation modes are illustrated in Figure 9. Carrier Aggregation can be deployed differently to the network; for example, to improve the cell edge throughput or to increase throughput in hot spots. Examples of possible CA deployment scenarios are illustrated in Figure 10. European operators usually have a spectrum from different bands, and 3GPP has specified different band combinations to support Carrier Aggregation. Table 1 presents E-UTRA operating bands used by Finnish operators. Table 2 presents CA E-UTRA operating bands and combinations that can be used by Finnish operators.

4.2.1 Carrier Aggregation Modes

In Carrier Aggregation, the user has several serving cells. The cells may have different coverage areas or the cell size may differ because of different frequency bands or because the cells are located in different base stations. The UE is connected to one Primary Cell (PCell), which handles the RRC connection and security parameters, for example. PCell is only changed at handover procedure. PCell is served by the Primary Component Carrier (PCC) both in UL and in DL. The other serving cells are referred as Secondary Cells (SCells), which are served by Secondary Component Carriers (SCCs). The SCCs are primarily used for bandwidth expansion and can be added or removed by the network, for example to match the UE's traffic demand. [26.] Figure 9 illustrates different CA modes.

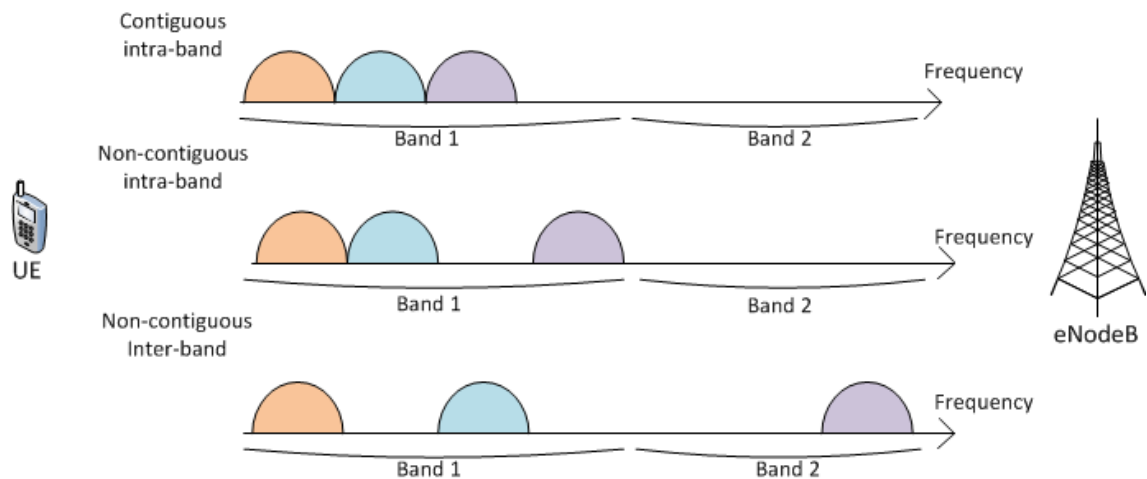

Figure 9. Carrier Aggregation modes. Contiguous intra-band, non-contiguous intra-band and non-contiguous inter-band [26].

Contiguous Intra-band aggregation is a CA mode, in which the carriers are adjacent to each other and are located in the same frequency band. The carriers are separated by a multiple of 300 kHz so that the sub-carriers are orthogonal to each other and do not interfere. This is the simplest form of CA in LTE to implement, and it is usable if operator has more than 20 MHz bandwidth available from the same frequency band. [11, p. 441-442.]

Another CA mode is non-contiguous intra-band aggregation, which means that the carriers are located in the same frequency band, but are not adjacent. Fragmented spectrum can be exploited by operators with wide overall bandwidth, but with limited single wideband spectrum allocation. In this scenario, the UE has to use separate transceivers for each carrier. [26.]

The third CA mode is inter-band aggregation, where the CCs are located in different frequency bands, such as 1800 MHz and 2600 MHz. This scenario is useful for operators, but challenging for the UE, as it is necessary to include a transceiver for each carrier and to ensure the effective use of different frequency bands simultaneously. [11, p. 441-442.]

4.2.2 Carrier Aggregation Deployment Scenarios

Carrier Aggregation can be deployed to the network in several different manners, and Figure 10 illustrates some of the possible CA deployment scenarios. The cases A and B are currently the most common deployment scenarios in the operator network. Also, it is likely that when Small Cells and Relay Nodes become more commonly used, other deployment scenarios will be developed in the near future.

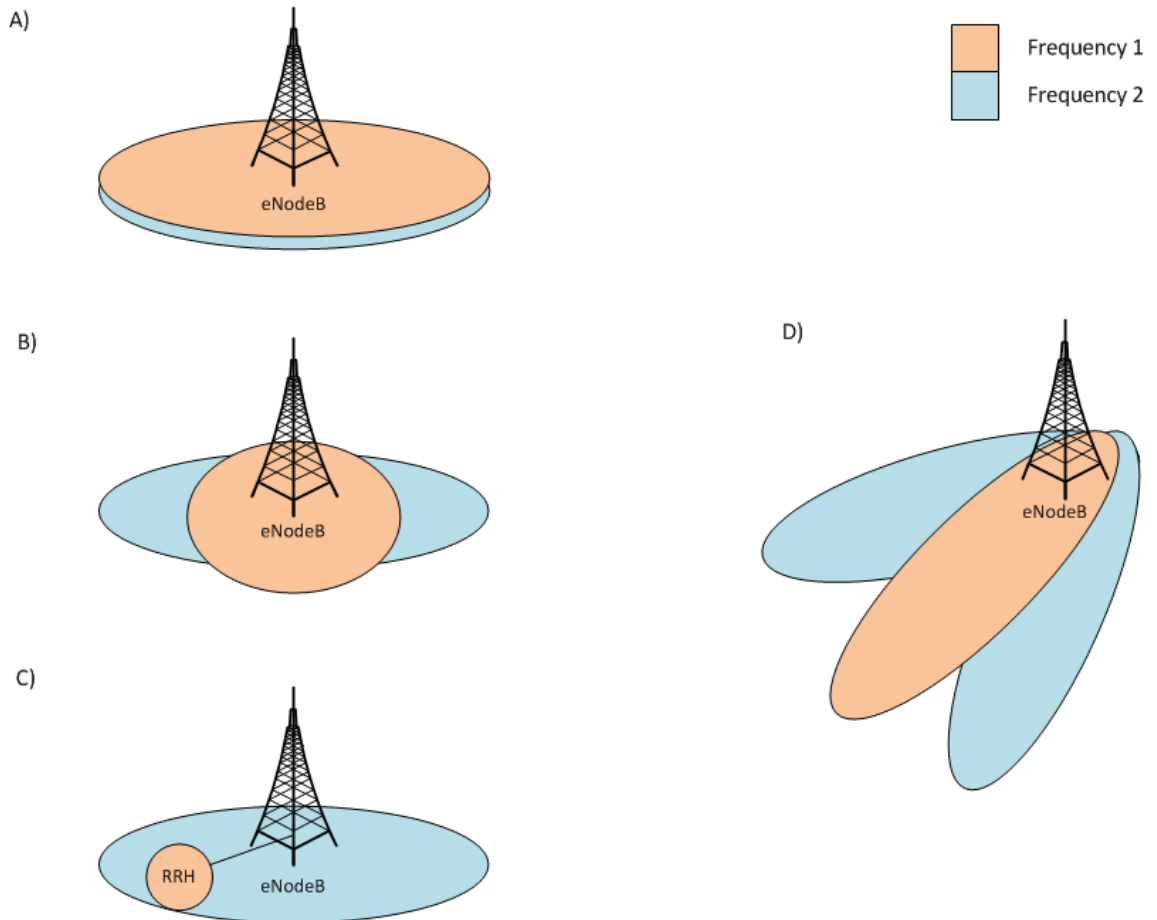

Figure 10. CA deployment scenarios. Aggregation is possible between the overlapping Frequency 1 and Frequency 2 cells [28].

The aggregated carriers can be co-located and with nearly the same coverage areas as in case A. It is likely that the band is same for the carriers in case A. The coverage areas may also differ due to different frequency as in case B or, for example use of Remote Radio Head (RRH) as in case C. [28.]

In case B, the frequency 1 could be 800 MHz and frequency 2 could be 2600 MHz. Case C provides macro cell coverage in the area and RRHs are used in hot spots to increase throughput. The coverage area can also differ because antenna patterns or antenna tilts as in case D, where antenna of frequency 2 is directed to improve the coverage near the cell edges of frequency 1. CA is possible in the overlapping coverage areas and will increase the peak data rate and improve the data rate near cell edge. [28.]

4.2.3 Band Combinations

E-UTRA is designed to operate in certain bands specified by 3GPP, and nearly 50 E-UTRA operating bands have been defined. Table 1 presents the operating bands mostly used in Finland. Carrier Aggregation has been supported since LTE Release 10, but it introduced a limited number of CA configurations. Since Release 10, many more combinations have been specified and for example, LTE Release 12 offers 3 Carrier Aggregation band combinations to be used. Band combinations are specified by 3GPP and typically for a specific region. CA bandwidth classes are also defined by 3GPP. Bandwidth classes specify the maximum transmission bandwidth and maximum number of CCs. For example, CA bandwidth class D allows bandwidth of 60 MHz and the maximum number of three CCs, while class A aggregated bandwidth is limited to 20 MHz and only for one CC.

Table 1. E-UTRA operating bands 3, 7 and 20 [31].

E-UTRA Operating band	UL Operating band	DL Operating band
3	1710 MHz – 1785 MHz	1805 MHz – 1880 MHz
7	2500 MHz – 2570 MHz	2620 MHz – 2690 MHz
20	832 MHz – 862 MHz	791 MHz – 821 MHz

In Finland, operators use E-UTRA operating bands 20, 3 and 7. [29, p. 46-47.] For example E-UTRA operating band 20 base stations transmit band operates between 791 and 821 MHz, and in Finland is allocated between DNA Oy, TeliaSonera Finland and Elisa Oyj. TeliaSonera Finland Oyj uses 801-811 MHz band with the total bandwidth of 10 MHz. [30.]

Table 2. Intra-band contiguous CA operating bands [31].

E-UTRA CA band	E-UTRA Operating band	UL Operating band	DL Operating band
CA_3	3	1710 MHz – 1785 MHz	1805 MHz – 1880 MHz
CA_7	7	1500 MHz – 2570 MHz	2620 MHz – 2690 MHz
CA_3-7	3	1710 MHz – 1785 MHz	1805 MHz – 1880 MHz
	7	1500 MHz – 2570 MHz	2620 MHz – 2690 MHz
CA_3-20	3	1710 MHz – 1785 MHz	1805 MHz – 1880 MHz
	20	832 MHz – 862 MHz	791 MHz – 821 MHz
CA_7-20	7	1500 MHz – 2570 MHz	2620 MHz – 2690 MHz
	20	832 MHz – 862 MHz	791 MHz – 821 MHz
CA_3-7-20	3	1710 MHz – 1785 MHz	1805 MHz – 1880 MHz
	7	1500 MHz – 2570 MHz	2620 MHz – 2690 MHz
	20	832 MHz – 862 MHz	791 MHz – 821 MHz

Carrier Aggregation has been specified in different E-UTRA operating bands, but not to all of them. Table 2 presents some of the intra-band contiguous CA operating bands such as CA_3 and inter-band CA operating bands such as CA_3-7-20. For example, CA_3 is defined for the E-UTRA operating band 3, and it enables the use of intra-band contiguous Carrier Aggregation between 1805 MHz and 1880 MHz. TeliaSonera Finland Oyj possesses 1805.100-1829.900 MHz band in E-UTRA operating band 3 [30], and is therefore able to use a total of 24.8 MHz of aggregated bandwidth, using intra-band contiguous Carrier Aggregation in E-UTRA CA band 3. Inter-band CA operating bands are specified and combined individually to each operating band combinations.

A limited amount of three band combinations are specified by 3GPP in Releases 12 and 13, and it is expected that there are more to be specified. E-UTRA CA band CA_3-7-20 is specified in Release 12, which allows the inter-band aggregation of operating bands 3, 7 and 20, and the maximum aggregation of 60 MHz using three CCs. In Finland, this combination is highly useful for operators because each of the Finnish operators have fragmented spectrum and with inter-band aggregation it can be utilized efficiently. Four band inter-band CA combinations and over 50 three CC inter-band CA combinations are specified in Release 13. [31.]

4.3 Cell and Mobility Management

CCs corresponding to the PCell and SCells are referred as PCC and SCCs. CA capable UE has one DL and UL PCC and at least one SCC both in DL and UL. PCell is initially configured during the connection establishment and it is responsible for providing NAS mobility information, RRC connection maintenance and security input. A single UE has only one RRC connection, regardless of how many carriers are being aggregated. PCell can be changed for the UE by the handover procedure, which allows the source PCell to hand over all the necessary information to the target PCell. [29, p. 34.] Handover is done if the UE moves away from the serving eNodeB coverage area.

Mobility measurements are based on the PCell, and the eNodeB will signal the target cell of the incoming handover. After the handover, SCells can be added or reconfigured with the target PCell. The SCells can be removed with the handover message if the target cell does not support CA. [29, p. 36.]

Because there is only one PCell for the UE, the other aggregated carriers are considered as SCells. SCell is configured after the PCell, mainly to provide larger bandwidth and throughput. The number of SCells that can be configured depends on the UE capabilities. If the UE is inactive and there is no data activity on the SCell, it will be deactivated.

4.4 UE Capabilities and Theoretical Expectations

3GPP has specified UE categories, which define and segment the UE to a certain category. UE Categories ensure that the eNodeB is efficiently able to communicate with the UE. The initial LTE Release introduced categories 1 - 5 and Release 10 introduced categories 6, 7 and 8. Release 13 introduced categories up to Cat. 12. The categories define the UEs DL and UL capabilities and overall performance, for example, MIMO support and maximum bit rates. [32.]

Table 3 presents UE categories defined in 3GPP LTE Release 13. Maximum DL and UL rates are presented in Megabits per second. Radio Frequency (RF) bandwidth is presented in MHz. For example, peak DL data rate for Category 5 UE is nearly 300

Mbps and 75 Mbps in the UL. Category 5 UE is capable of using 4x4 MIMO in the DL and 64-QAM modulation in the UL.

Table 3. UE categories and capabilities defined by 3GPP. [32]

UE Category	Maximum DL data rate	Spatial multiplexing layers in DL	Maximum UL data rate	64-QAM support in UL	RF bandwidth
Category 1	10	1	5	No	20
Category 2	51	2	25	No	20
Category 3	102	2	51	No	20
Category 4	150	2	51	No	20
Category 5	299	4	75	Yes	20
Category 6	301	2 or 4	51	No	40
Category 7	301	2 or 4	102	No	40
Category 8	2998	8	1497	Yes	100
Category 9	452	2 or 4	51	No	60
Category 10	452	2 or 4	102	No	60
Category 11	603	2 or 4	51	No	80
Category 12	603	2 or 4	102	No	80

The theoretical maximum peak data rates depend on several factors, but the focus in this thesis is on 3CC Carrier Aggregation. Carrier Aggregation has a direct impact on peak data rates and depending on the network load, the average data rates may also increase.

Category 3 and 4 devices support DL data rates of 100 and 150 with continuous 20 MHz spectrum allocation and 2x2 MIMO. 2CC Carrier Aggregation and Category 6 devices support 300 Mbps with 20 + 20 MHz and 2x2 MIMO. Category 9 devices support 450 Mbps with 3CC CA aggregating 60 MHz and 2x2 MIMO. Aggregating 20 + 20 + 10 MHz with 3CC CA a throughput of 375 Mbps can be achieved. In the future, it is expected that commercial devices will support 1 Gbps with total bandwidth of 100 MHz. Currently data rates are limited by the amount of spectrum that can be allocated for the connection, and operators that have more spectrum resources available have the advantage to deliver higher data rates. [33.]

In Finland, operators typically have spectrum in 1800 and 2600 MHz, but only 10 MHz with 800 MHz band. In such case, operator is able to utilize a total of 50 MHz of spectrum, which results to a peak data rate of 375 Mbps in the DL when using 3CC CA capable UE. As previously discussed, 450 Mbps could theoretically be achieved when using 3CC CA with 60 MHz. [33.]

4.5 Future Enhancements and Development

It is expected that Carrier Aggregation will continue to develop in the future 3GPP releases. The next step is aggregating four and five carriers and utilize a total of 80 and 100 MHz of spectrum. UEs are constantly developing and with the use of 256-QAM modulation, the peak data rate for a single 20 MHz carrier can in theory reach 200 Mbps in the DL.

Peak data rates of 1 Gbps is theoretically achievable when aggregating five Component Carriers and a total of 100 MHz spectrum. Peak data rates can be further improved by adding more than 2 MIMO streams. LTE Release 13 aims to extend the maximum number of aggregated carriers up to 32, which in theory enables peak data rates of 6.4 Gbps with two antenna operation and even further with eight antenna operation. [33.]

5 Research Material and Methods

The test data used in this thesis was provided by TeliaSonera and processed and analyzed by the author. The Key Performance Indicators (KPIs) chosen to be evaluated were application layer throughput, physical layer throughput, Block Error Ratio (BLER), SNR and Reference Signal Received Power (RSRP). The choice was made to evaluate DL throughput between 3CC CA and 2CC CA because Carrier Aggregation has an impact on the throughput and peak data rates. Data transmission measurements and radio conditions are evaluated using RSRP, SNR and BLER. Also, modulation is determined by radio conditions.

5.1 Test and Processing Tools

Measurements were conducted in the commercial network of TeliaSonera by downloading a 4 GB dummy file from FTP server. The data was gathered by using Anite's Nemo Handy software, which is a widely used professional handheld test tool, suitable for performing measurements both outdoors and indoors. Nemo Handy logs RF and signaling data during the measurements, which can be accessed later with post-processing tools.

To process and analyze the captured data, Anite's Nemo Analyze was used. It is a post-processing tool from Anite, which is used for analyzing, benchmarking, troubleshooting and statistical reporting based on test data. Scripts were created using Nemo Analyze and the output was imported to Microsoft Excel. The graphical presentations of the measurements were created using Excel.

5.2 Measurement Setup

2CC CA and 3CC CA measurements were done separately and stationary from the same location. 3CC CA measurement data was captured using Samsung Galaxy S6 edge plus, which is a 3CC CA capable Category 9 UE. Galaxy S6 edge plus is capable of achieving 450 Mbps in the DL using 2x2 MIMO and combining up to 60 MHz of bandwidth. 2CC CA measurement data was captured using Samsung Galaxy Note 4, which is a CA capable Category 6 UE. Samsung Galaxy Note 4 is capable of achieving

300 Mbps in the DL using 2x2 MIMO and combining up to 40 MHz of bandwidth. 2x2 MIMO was utilized in 3CC CA and 2CC CA measurements.

LTE frequencies used in this study were 800 MHz, 1800 MHz and 2600 MHz. Frequencies correspond to E-UTRA operating bands 20, 3 and 7. Band 20 is frequency 800 MHz, from which a total of 10 MHz was aggregated. Band 3 is frequency 1800 MHz, from which a total of 20 MHz was aggregated. Band 7 is frequency 2600 MHz, from which a total of 20 MHz was aggregated. In 3CC CA, a total of 50 MHz of bandwidth was aggregated. In 2CC CA, a total of 40 MHz of bandwidth was aggregated.

5.3 KPIs Used in Measurements

The throughput was measured from the application layer and physical layer. Physical layer measurements allow the separation of individual component carriers and their throughput measurements, which enables the comparison between individual Component Carriers in 3CC CA and 2CC CA.

Physical Downlink Shared Channel (PDSCH) throughput is the physical layer throughput, which is considered to be more of a theoretical throughput. The physical layer throughput includes more information such as header information and overhead, which is generated by the other physical channels and signals. PDSCH is a shared channel and its throughput capability is shared by all users, and if the number of users increase, the throughput per user is reduced. Also, if users experience poor signal conditions, the total cell throughput is reduced. Application layer throughput measurements on the other hand correspond the actual data rates, which the user experiences. Therefore, application layer throughput is used for demonstrating the actual data rates.

The performance of LTE and any wireless system depends on the prevailing radio conditions, which are determined by RSRP and SNR measurements. RSRP is a measure of signal strength and it is used by the UE for cell selection and reselection; UE reports RSRP to the network as a part of the handover procedure. SNR is a measure of signal quality and it is used in generating Channel Quality Indicator (CQI) feedback, which is reported to the network. BLER is defined as the ratio of the number

of erroneous blocks received to the total number of blocks sent. It measures how successful data transmission is at the physical layer. Target BLER is typically set to maximum of 10% and the average success rate is thereby 90% on average.

6 Performance Measurements

This chapter includes the 3CC CA and 2CC CA measurement results. The graphical illustrations of the measurement results are also presented in this chapter. The results are further discussed and evaluated in Chapters 7 and 8.

6.1 3CC CA Measurements

3CC CA measurements were captured in the commercial network of TeliaSonera during December 2015. PCell used band 7, which operates at 2600 MHz frequency. PCell utilized bandwidth of 20 MHz. SCell1 used band 3, which operates at 1800 MHz frequency. SCell1 utilized bandwidth of 20 MHz. SCell2 used band 20, which operates at 800 MHz frequency. SCell2 utilized bandwidth of 10 MHz, thus the aggregated bandwidth was 50 MHz. Radio conditions are evaluated using RSRP and SNR measurements. Radio conditions determine which modulation scheme is allowed. BLER is used to measure the success of data transmission over the air. Also, Spatial Multiplexing with 2x2 MIMO was used.

6.1.1 Application Layer Throughput

Application throughput is the actual throughput which the end user experiences. The 4 GB dummy file was downloaded twice from the FTP in this measurement, thus the significant drop in the graph. Graph 1 illustrates the application throughput in the DL using 3CC CA.

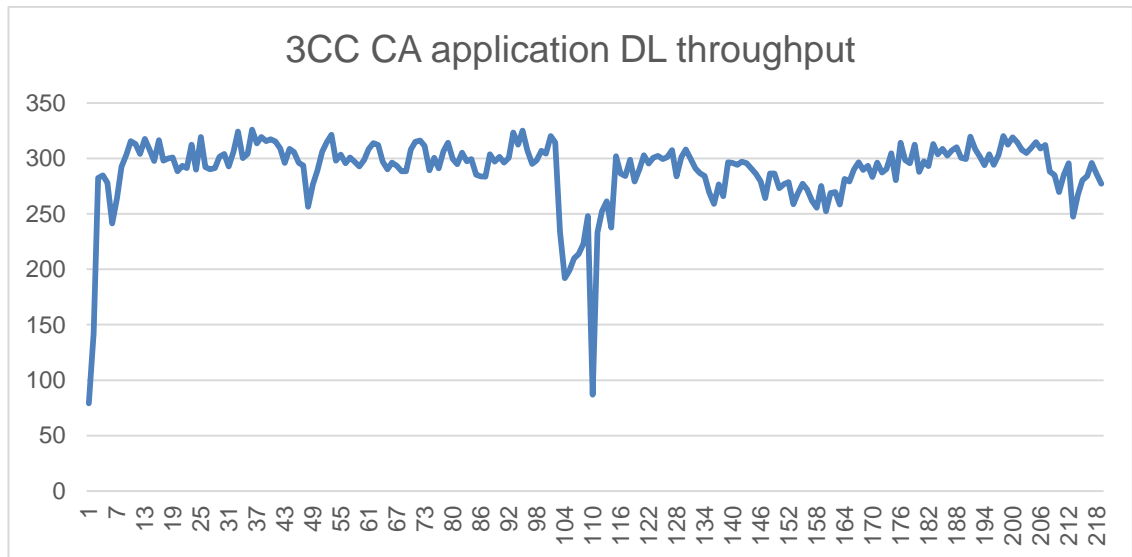

Graph 1. LTE 3CC CA application throughput

The peak application throughput using 3CC CA was 326.03 Mbps. The throughput remained stable throughout the measurement, which allowed the average throughput of 289.60 Mbps in the DL.

6.1.2 Physical Layer Throughput

PDSCH throughput is measured in the present study because individual CC throughput can be separated from the total throughput. PCell, Scell1 and Scell2 Component Carrier throughput is presented in Graph 2.

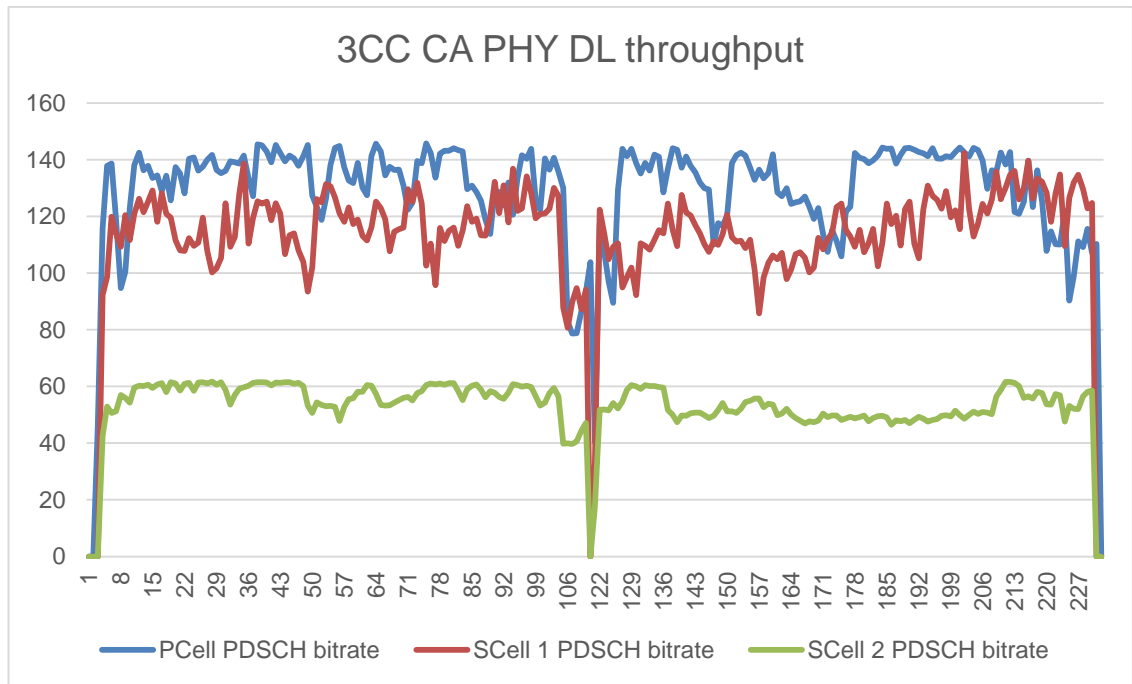

Graph 2. 3CC CA Physical layer throughput. Individual throughputs for PCell and Scells.

The average PDSCH throughput was 130.29 Mbps for PCell, 115.29 Mbps for SCell1 and 54.18 Mbps for SCell2. The average 3CC CA PDSCH throughput was 298.22 Mbps and peak PDSCH throughput was 339.88 Mbps. PCell and SCell1 provided nearly the same throughputs, which consisted of 84% of the total throughput. PCell and SCell1 used higher bands and utilized larger bandwidths than SCell2.

6.1.3 RSRP and SNR

In this thesis, RSRP values higher or equivalent to -80 dBm are considered as excellent. RSRP value range from -80 to -90 dBm is considered as good and below -90 dBm is considered as fair. SNR values higher or equivalent to 20 dB are considered as excellent. SNR value range from 13 to 20 dB is considered as good and 0 to 13 dB as fair.

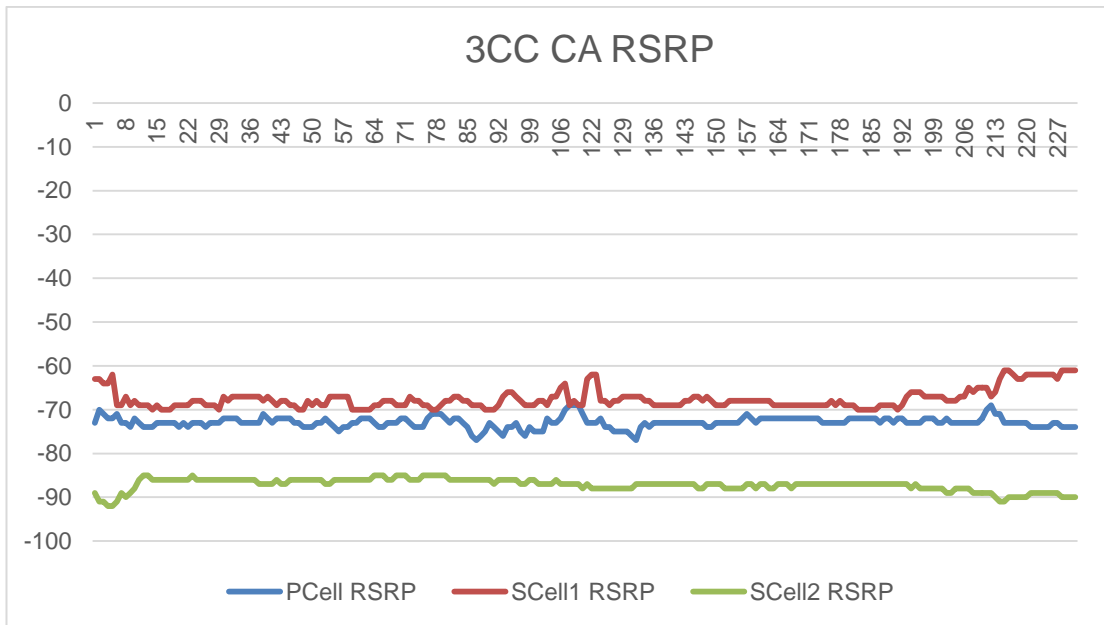

Graph 3. Individual RSRP values for PCell, SCell1 and SCell2.

The average PCell RSRP value was -72.91 dBm, average SCell1 RSRP value was -67.51 dBm and average SCell2 RSRP value was -87.20 dBm. PCell and SCell1 values indicate that radio conditions are excellent, while SCell2 RSRP indicates good radio conditions. Graph 3 illustrates individual RSRP values and Graph 4 illustrates individual SNR values.

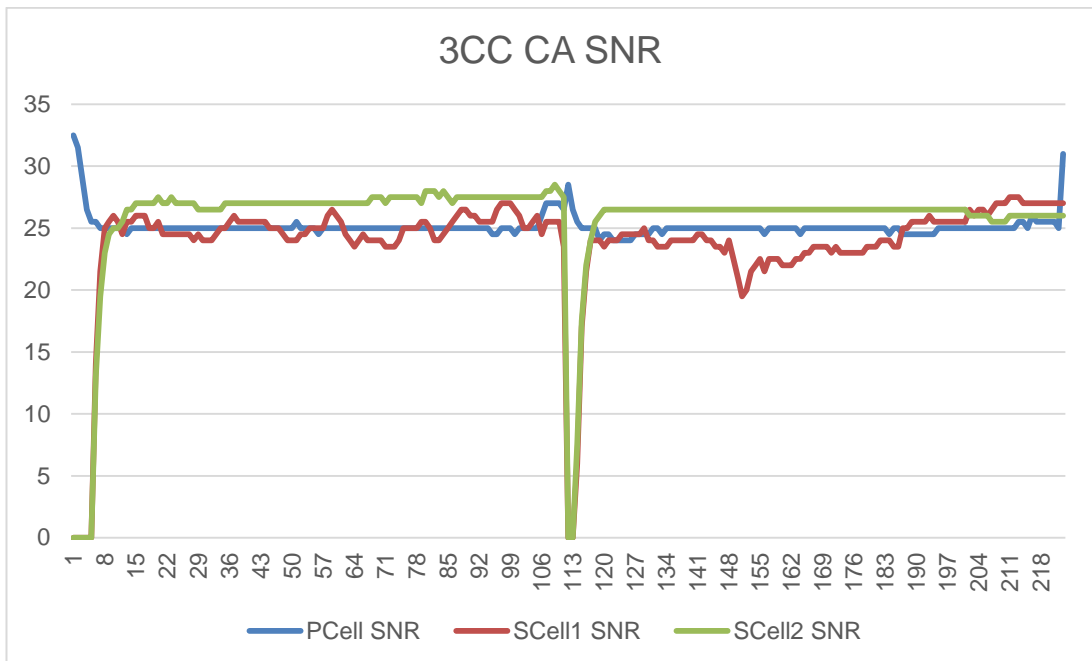

Graph 4. Individual SNR values for PCell, SCell1 and SCell2.

The average PCell SNR value was 25.1 dB, average SCell1 SNR value was 24.3 dB and average SCell2 SNR value was 26.2 dB. All of the measured SNR values are considered as excellent. During the test file download, PCell SNR dropped from 32 dB to a stable 25 dB, which was due to the noise generated from SCells. Despite the drop, 25 dB is still considered as an excellent condition. Excellent radio conditions enabled the use of 64-QAM modulation for all CCs.

6.1.4 BLER

PCell, SCell1 and SCell2 BLER measurement data is presented on top of each other for graphical purposes. The graph illustrates that the BLER values were varying for the carriers and none of the carriers had significantly higher BLER value than the others. Graph 5 illustrates the BLER measurements.

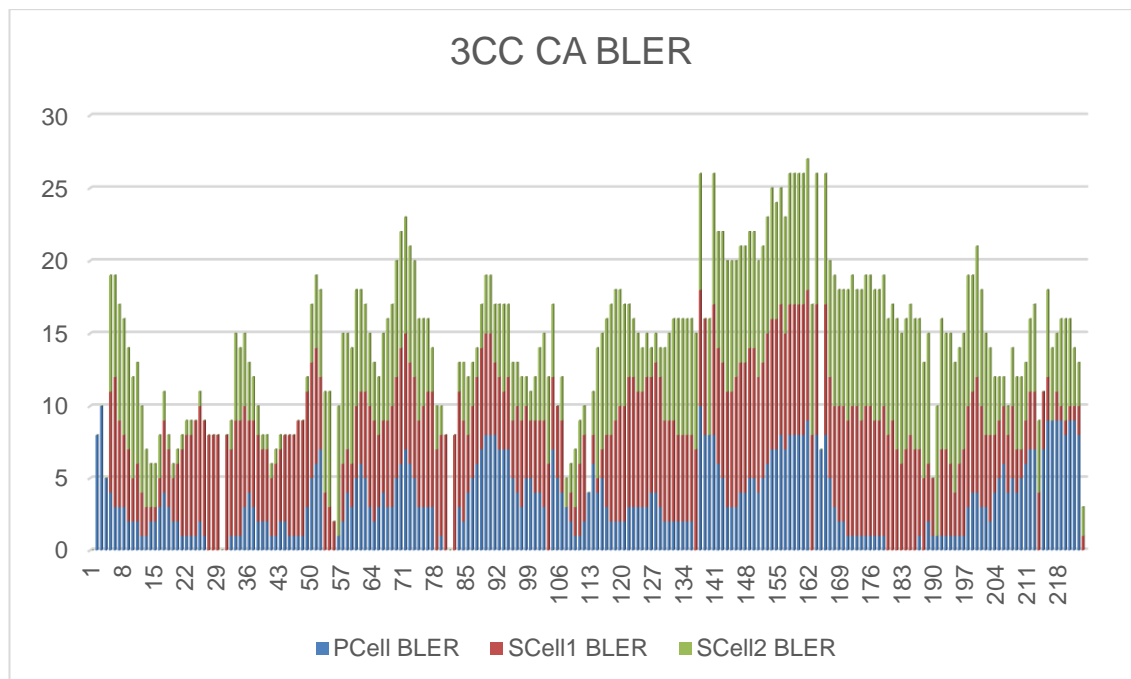

Graph 5. 3CC CA BLER measurement.

The average BLER for PCell was 3.43%, 5.78% for SCell1 and 5.23% for SCell2. PCell BLER peak was 10%, while SCell1 and 2 peak was 9%. BLER values were relatively low and the carriers did not peak above the optimal threshold of 10%.

6.2 2CC CA Measurements

In 2CC CA measurements, PCell used band 3, which operates at 1800 MHz frequency. PCell utilized a bandwidth of 20 MHz. SCell used band 7, which operates at 2600 MHz frequency. SCell utilized a bandwidth of 20 MHz. Thus, aggregated bandwidth was 40 MHz. Radio conditions were evaluated using RSRP and SNR measurements. Also, the radio conditions determine the used modulation scheme. Success of data transmission over the air was measured using BLER. Spatial Multiplexing with 2x2 MIMO was used.

6.2.1 Application Layer Throughput

The application throughput average using 2CC CA was 178.64 Mbps. The application peak throughput was 261.82 Mbps. 2CC CA Application throughput is illustrated in Graph 6.

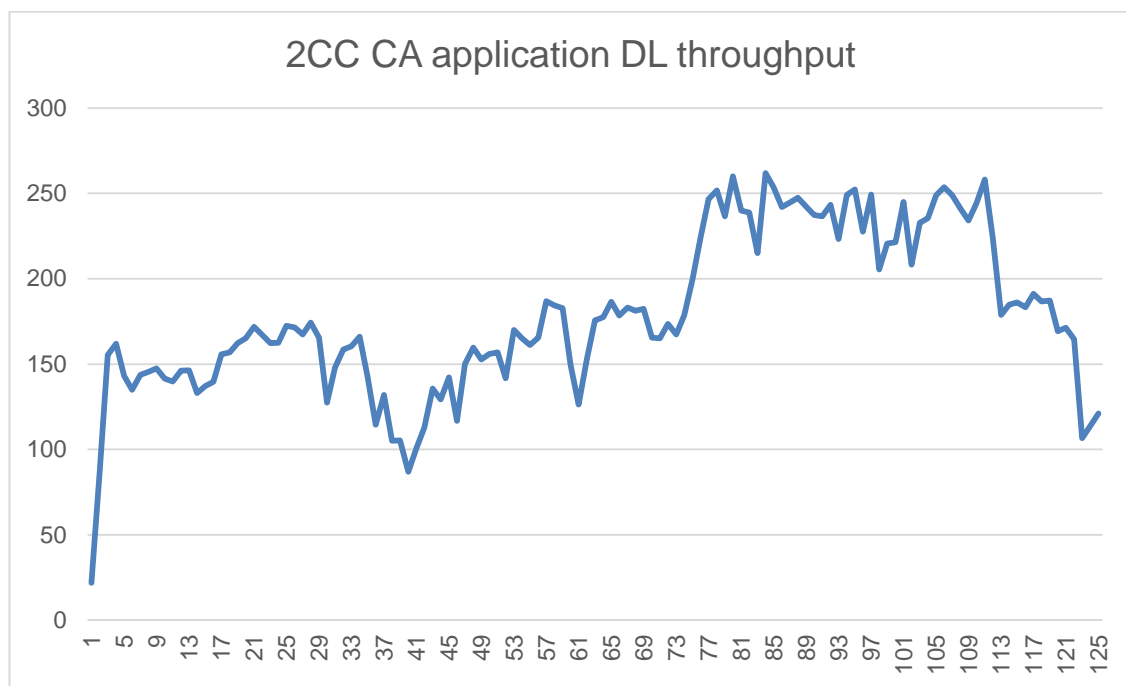

Graph 6. Application throughput using 2CC CA.

The 2CC CA throughput was not as stable as the 3CC CA throughput was. The average throughput suffered from the unstable performance and the average data rates did not reach the peak data rates until after the halfway of the test.

6.2.2 Physical Layer Throughput

The physical layer throughput explains the relatively low average application layer throughput. PCell throughput remained near 70 Mbps until the halfway of the measurements. PDSCH throughput measurements for individual CCs are presented in Graph 7.

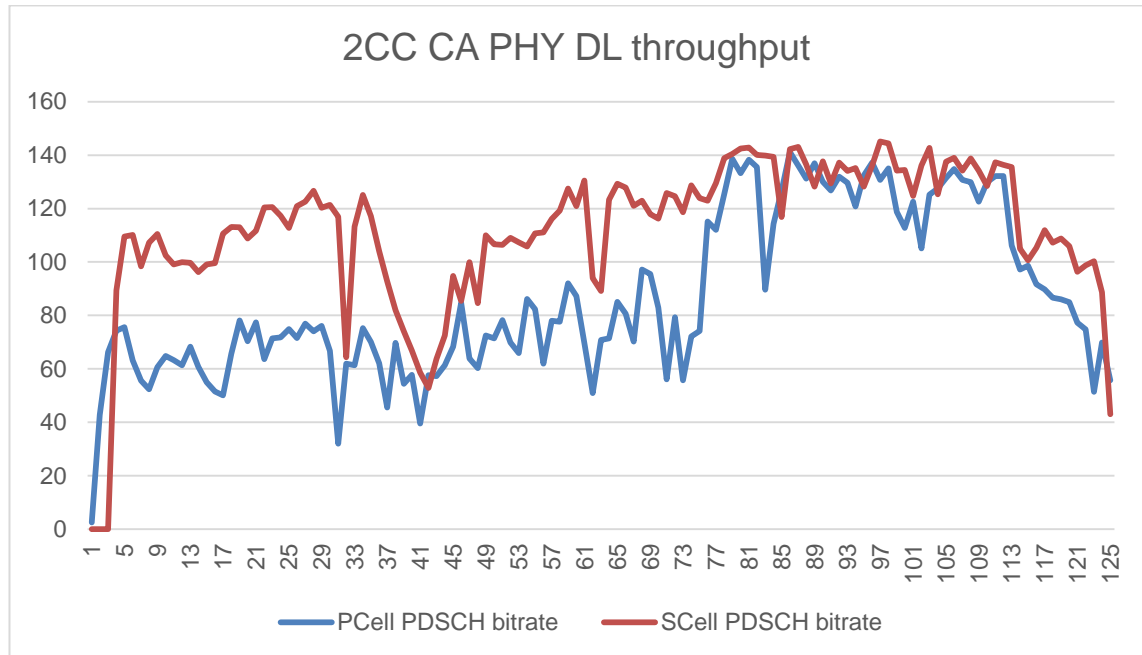

Graph 7. Physical layer throughput using 2CC CA.

The physical layer average throughput for PCell was 86.39 Mbps and 114.73 Mbps for SCell. The peak throughput for PCell was 141.16 Mbps and 145.08 Mbps for SCell. PCell throughput nearly doubled as the test reached halfway. SCell throughput was more stabilized than PCell throughput. 2CC CA physical layer throughput average was 198.37 Mbps and 2CC CA peak throughput was 283.44 Mbps.

6.2.3 RSRP and SNR

RSRP measurements indicate that radio conditions changed during the tests, which explains the underwhelming throughput performance. The measurements clearly show that the overall throughput increased as RSRP improved. RSRP is presented in Graph 8 and SNR in Graph 9.

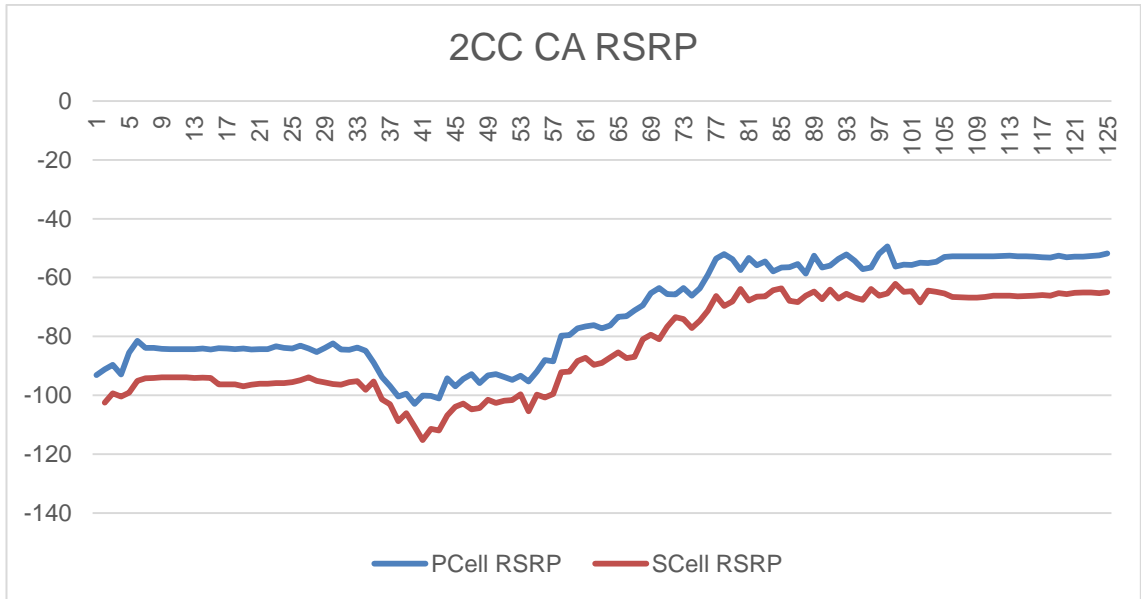

Graph 8. RSRP in 2CC CA measurements.

The average PCell RSRP value was -72.53 dBm and average SCell RSRP value was -83.61 dBm. PCell average radio conditions were considered as excellent and SCell average radio conditions as good.

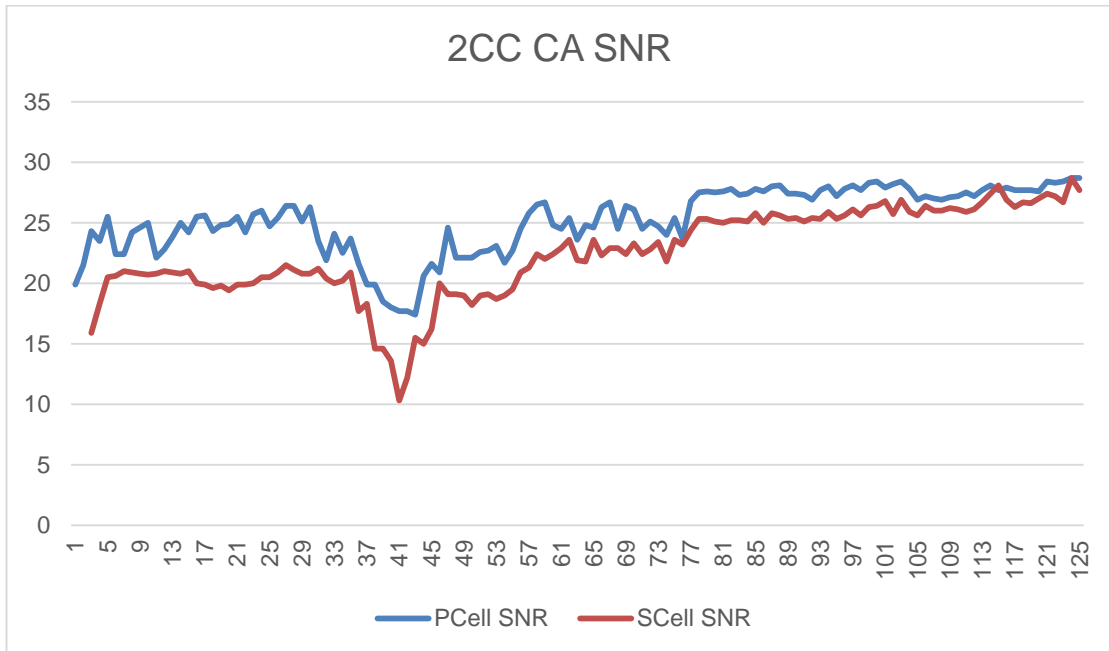

Graph 9. SNR in 2CC CA measurements.

The PCell SNR average was 25.2 dB and SCell SNR average was 22.4 dB. These measurements are considered as excellent. SCell SNR suffered a significant drop,

which had an effect on the overall throughput. Radio conditions enabled the use of 64-QAM for both CCs during the test.

6.2.4 BLER

Graph 10 demonstrates that the overall throughput grew as BLER decreased. BLER values averaged at 8% for both carriers after decreasing towards more desired values. Graph 10 illustrates BLER measurements in 2CC CA.

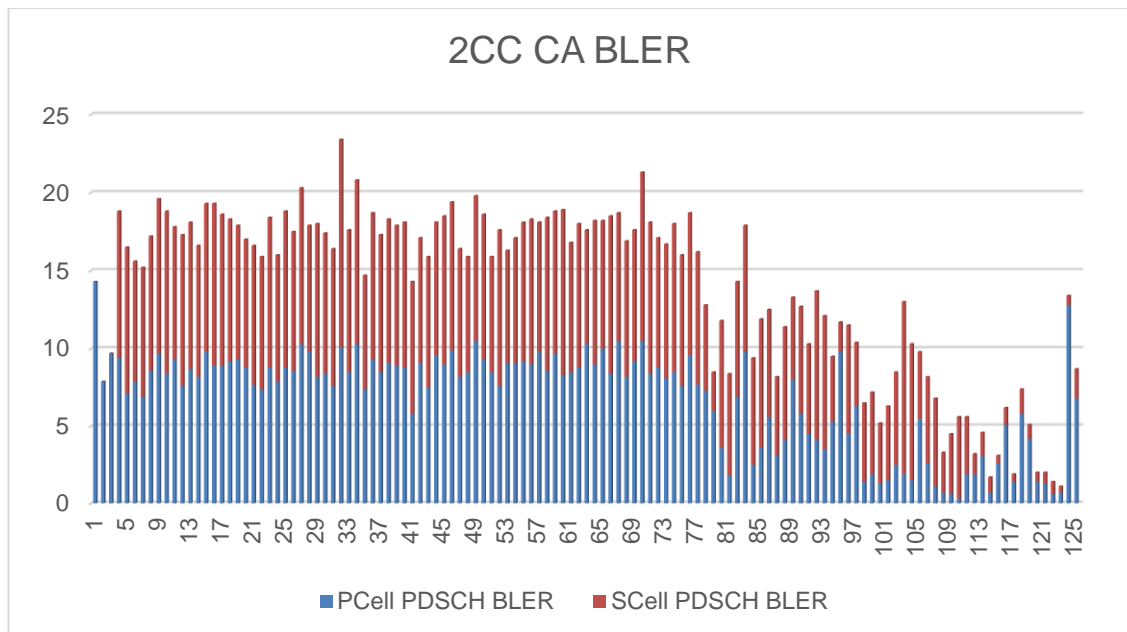

Graph 10. BLER in 2CC CA measurements.

The PCell BLER average was 6.88% and SCell BLER average was 7.23%. The PCell peak BLER was 14.30% and SCell peak BLER was 13.30%. BLER values remained below 10% for most of the time, which is the desired result. Peaks above 10% were also experienced, which had an effect on the overall throughput.

7 Performance Evaluation

Results from 3CC CA and 2CC CA measurements are presented in Table 4. The results can be compared to each other to point out the possible advantages or disadvantages. First, the characteristics are presented for each CC. Secondly, the application and physical layer throughput performance results are presented, which are followed by the BLER measurement results. Lastly, the radio condition and quality results are presented. The test measurements included only the DL performance.

Table 4. 3CC CA and 2CC CA measurement results.

3CC CA		2CC CA	
Characteristics		Characteristics	
PCell frequency	2600 MHz	PCell frequency	1800 MHz
PCell bandwidth	20 MHz	PCell bandwidth	20 MHz
SCell1 frequency	1800 MHz	SCell frequency	2600 MHz
SCell1 bandwidth	20 MHz	SCell bandwidth	20 MHz
SCell2 frequency	800 MHz		
SCell2 bandwidth	10 MHz		
Total bandwidth	50 MHz	Total bandwidth	40 MHz
Modulation	64-QAM	Modulation	64-QAM
MIMO mode	Spatial Multiplexing 2x2	MIMO mode	Spatial Multiplexing 2x2
Application layer throughput		Application layer throughput	
Average	289.60 Mbps	Average	178.64 Mbps
Peak	326.03 Mbps	Peak	261.82 Mbps
PHY layer throughput		PHY layer throughput	
PCell average	130.29 Mbps	PCell average	86.39 Mbps
SCell1 average	115.29 Mbps	SCell average	114.73 Mbps
SCell2 average	54.18 Mbps		
3CC CA average	298.22 Mbps	2CC CA average	198.37 Mbps
3CC CA peak	339.88 Mbps	2CC CA peak	283.44 Mbps
BLER		BLER	
PCell average	3.43%	PCell average	6.88%
SCell1 average	5.78%	SCell average	7.23%
SCell2 average	5.23%		

RSRP		RSRP	
PCell average	-72.91 dBm	PCell average	-72.53 dBm
SCell1 average	-67.51 dBm	SCell average	-83.61 dBm
SCell2 average	-87.20 dBm		
SNR		SNR	
PCell average	25.1 dB	PCell average	25.2 dB
SCell1 average	24.3 dB	SCell average	22.4 dB
SCell2 average	26.2 dB		

The radio conditions were considered as excellent and allowed the use of 64-QAM modulation in both measurements. However, the radio conditions were not completely identical during the measurements. PCell RSRP values were nearly the same, but the SCell RSRP values differed. The difference in throughputs is partially explained with the different radio conditions or due to network load. 2CC CA throughput performance reached the expected data rates until the halfway of the test, when the radio conditions improved. However, the addition of third Component Carrier was more important of a factor regarding throughput performance.

The application layer peak throughput using 3CC CA was nearly 20% higher compared to the 2CC CA application layer peak throughput. Also, the physical layer peak throughput was nearly 17% higher in 3CC CA. In terms of Mbps, 3CC CA allowed a 64.21 Mbps higher application layer peak throughput than 2CC CA. In the physical layer, the difference in throughputs was 56.44 Mbps, which was almost the average throughput of SCell2.

The 3CC CA throughput, SNR and RSRP values remained very stable during the test, which explains the good average throughput performance. The 2CC CA throughput increased after RSRP values improved, which explains the relatively low average throughput performance. 3CC CA allowed a 110.96 Mbps gain in application layer average throughput, which is partially explainable due to the change in the radio conditions during the 2CC CA tests. The BLER values were more optimal in the 3CC CA measurements. However, 2CC CA BLER decreased as the radio conditions improved. 3CC CA BLER, on the other hand, had a slight increase towards the end of the test while radio conditions remained the same. The 3CC CA PCell BLER average was only 3.43%, as in 2CC CA PCell BLER the average was 6.88%. Thus, more data was retransmitted in 2CC CA measurements and it had an impact on the throughput.

According to the test measurements, the end user experiences a 38% growth in the average throughput when using 3CC CA instead of 2CC CA.

8 Discussion and Conclusions

In theory, Cat.9 UE is capable of achieving 375 Mbps in the downlink using 50 MHz of aggregated bandwidth. Cat.6 UE is capable of achieving 300 Mbps in the downlink using 40 MHz of aggregated bandwidth. In a commercial live network, the theoretical peak data rates are not often or easily achieved. Data rates are also visible to the end user, unlike the technology behind the data rates. In Carrier Aggregation, the user does not know whether there are two, three or four Component Carriers aggregated. This thesis proved that the end user will benefit from aggregating three Component Carriers.

An application layer peak throughput of 326.03 Mbps and average throughput of 289.60 Mbps was achieved using 3CC CA. Also, BLER percentage did not increase when 3CC CA was used, and radio conditions enabled the use of 64-QAM during the tests. The end user will experience a significantly better mobile broadband experience when using 3CC CA. Results proved that 3CC CA allows higher peak and average data rates in the DL compared to 2CC CA. In addition, 3CC CA performance was more stable compared to 2CC CA performance.

Future work regarding 3CC CA could include mobility performance evaluation, battery consumption evaluation and performance evaluation in changing radio conditions or near the edge of a cell. Also, the performance of uplink CA was not evaluated in this thesis and it could be an interesting subject for future studies. This thesis proved that in the near future Carrier Aggregation will be more common in commercial networks and that end users will experience the advantages of 3CC CA. Furthermore, aggregating four and five CCs is the obvious next step in Carrier Aggregation. Upcoming 3GPP Releases will have enhancements in Carrier Aggregation, which will have an extremely large impact on the overall performance of mobile broadband and the user experience.

In the future, Carrier Aggregation can also be effectively utilized with Small Cells and thus increase the throughput in traffic hot spots, which is a good subject for future study. Also, deployments of heterogeneous networks become more attractive with CA. Carrier Aggregation opens up new possibilities to improve indoor data rates, cell edge throughput and overall throughput.

The main objective in this thesis was to study the performance of 3CC CA in the commercial network of TeliaSonera. In addition, the aim was to find out the possible

gains for the end user when 3CC CA is used. In this thesis, the focus was on 3CC CA DL throughput. 2CC CA data measurements were compared with the 3CC CA measurement results to find out the possible advantages that 3CC CA offers and also to point out the disadvantages that might have occurred.

One of the most important study results was that the end user will experience a better mobile broadband experience when using 3CC CA. Another conclusion is that in order to achieve a throughput of 326 Mbps in the DL, excellent radio conditions are required. In this thesis, the performance of 3CC CA was not evaluated in poor radio conditions or near the edge of a cell. In terms of Mbps, the study results demonstrate that the user will have 110.96 Mbps faster average throughput in the application layer when 3CC CA is used. 3CC CA offered a total of 38% gain in application layer average throughput compared to 2CC CA.

According to the measurements, the demand for the increasing needs of an end user is solved by aggregating Component Carriers. In the future, more than three carriers can be aggregated and therefore throughput can be further increased.

References

- 1 ITU. Mobile-cellular subscription statistics. Online document. <<https://www.itu.int/en/ITU-D/Statistics/Pages/stat/default.aspx>> Read 3.2.2016.
- 2 Ericsson. 2015. Ericsson mobility report November 2015. Online document. <<http://www.ericsson.com/mobility-report>> Read 3.2.2016.
- 3 Tero Lehto. 2015. 5G Lupaa suuria. Mikrobitti November 3/2015, p. 60-61.
- 4 Harri Holma and Antti Toskala. 2011. LTE for UMTS: Evolution to LTE-Advanced, second edition. John Wiley & Sons, Ltd.
- 5 3GPP. 2010. Requirements for Evolved UTRA and Evolved UTRAN. Online document. <<http://www.3gpp.org/DynaReport/25913.htm>> Read 5.2.2016.
- 6 Magdalena Nohrborg. 2016. LTE Overview. Online document. 3GPP. <<http://www.3gpp.org/technologies/keywords-acronyms/98-lte>> Read 4.2.2016.
- 7 Seppo Hämmäläinen, Henning Sanneck and Cinzia Sartori. 2012. LTE self-organising networks (SON): network management automation for operational efficiency. John Wiley & Sons, Ltd.
- 8 Christopher Cox. 2014. An introduction to LTE LTE, LTE-Advanced, SAE, VoLTE and 4G Mobile Communications, second edition. John Wiley & Sons, Ltd.
- 9 Frederic Firmin. 2016. The Evolved Packet Core. Online document. 3GPP. <<http://www.3gpp.org/technologies/keywords-acronyms/100-the-evolved-packet-core>> Read 16.2.2016.
- 10 LSR. 2016. Basics of MIMO Radio Systems. Online document. <<https://www.lsr.com/white-papers/basics-of-mimo-radio-systems>> Read 26.2.2016
- 11 Erik Dahlman, Stefan Parkvall and Johan Sköld. 2014. 4G: LTE/LTE-Advanced for Mobile Broadband, second edition. Elsevier Ltd.
- 12 Jeanette Wannstrom. 2013. LTE-Advanced. Online document. 3GPP. <<http://www.3gpp.org/technologies/keywords-acronyms/97-lte-advanced>> Read 29.2.2016
- 13 Nokia. 2014. LTE-Advanced white paper. Online document. <<http://networks.nokia.com>> Read 29.2.2016

- 14 3GPP. 2016. LTE Release 12. Online document.
<<http://www.3gpp.org/specifications/releases/68-release-12>> Read 2.3.2016
- 15 3GPP. 2016. LTE Release 13. Online document. <<http://www.3gpp.org/release-13>>Read 2.3.2016
- 16 3GPP. 2016. LTE Release 14. Online document. <<http://www.3gpp.org/release-14>> Read 2.3.2016
- 17 3GPP. 2016. Ultimate portal, releases. Online document.
<<https://portal.3gpp.org/#55934-releases>> Read 2.3.2016. Updated 25.2.2016
- 18 Ericsson. 2015. LTE Release 13 white paper. Online document.
<http://www.ericsson.com/news/150417-lte-release-13_244069646_c> Read 8.3.2016
- 19 3GPP. 2013. Coordinated multi-point operation for LTE physical layer aspects.
<<http://www.3gpp.org/dynareport/36819.htm>> Read 3.3.2016
- 20 Ericsson. 2014. Heterogeneous networks white paper. Online document.
<http://www.ericsson.com/news/140911-heterogeneous-networks-securing-excellent-mobile-broadband-user-experience-everywhere_244099436_c> Read 7.3.2016
- 21 Nokia. 2016. Tele2 Netherlands boosts network capacity, indoor coverage with Nokia LTE small cells. Online document. <<http://networks.nokia.com/news-events/press-room/press-releases/tele2-netherlands-boosts-network-capacity-indoor-coverage-with-nokia-lte-small-cells>> Read 9.3.2016
- 22 TeliaSonera. 2016. Speed record in Omnitel's mobile network.
<<http://www.teliasonera.com/en/newsroom/news/2016/speed-record-in-omnitels-mobile-network-first-in-the-baltics-with-lte-advanced-pro/>> Read 9.3.2016
- 23 Nokia. 2015. LTE-Advanced Pro white paper. Online document.
<<http://networks.nokia.com>> Read 8.3.2016
- 24 Ericsson. 2015. Release 14 the start of 5G standardization. Online document.
<<http://www.ericsson.com/research-blog/lte/release-14-the-start-of-5g-standardization/>> Read 4.3.2016
- 25 Sonera. 2015. Lähes 400 Mbit/s huippunopeuksia Soneran 4G-verkossa.
<<https://www.sonera.fi/medialle/showArticleView?article=lhes-400-mbits-huippunopeuksia-soneran-4g-verkossa&id=b83710c2-9f1c-44be-987b-6c09a5ea6bfb>> Read 10.3.2016

- 26 Jeanette Wannstrom. 2013. Carrier Aggregation explained. 3GPP. <<http://www.3gpp.org/technologies/keywords-acronyms/101-carrier-aggregation-explained>> Read 11.3.2016
- 27 Nokia. 2014. LTE-A Carrier Aggregation infographic. Online document. <<http://networks.nokia.com>> Read 16.3.2016
- 28 3GPP. 2015. E-UTRA and E-UTRAN overall description. <<http://www.3gpp.org/dynareport/36300.htm>> Read 14.3.2016
- 29 Harri Holma and Antti Toskala. 2012. LTE-Advanced: 3GPP Solution for IMT-Advanced. John Wiley & Sons, Ltd.
- 30 Viestintävirasto. 2016. Radiolupapäätökset. Online document. <<https://www.viestintavirasto.fi/ohjausjavalvonta/laitmaarayksetpaatokset/lupapaatokset/radiolupapaatokset.html>> Read 30.3.2016
- 31 3GPP. 2016. LTE; E-UTRA; UE radio transmission and reception. Online document. <<http://www.3gpp.org/dynareport/36101.htm>> Read 1.4.2016
- 32 3GPP. 2016. LTE; E-UTRA; UE radio access capabilities. Online document. <<http://www.3gpp.org/DynaReport/36306.htm>> Read 3.4.2016
- 33 Harri Holma, Antti Toskala and Jussi Reunanen. 2016. LTE Small Cell Optimization: 3GPP Evolution to Release 13. John Wiley & Sons, Ltd