



## SMART CLOTHING

– Report of laboratory tests of smart clothing technologies and materials



Centria. Raportteja ja selvityksiä, 36

Inga Dāboliņa (editor)

## **SMART CLOTHING**

- Report of laboratory tests of smart clothing technologies and materials

**PUBLISHER:**

Centria University of Applied Sciences Talonpojankatu 2, 67100 Kokkola

**DISTRIBUTION:**

Centria Library

kirjasto.kokkola@centria.fi, tel. +358 40 808 5102

Layout: Centria University of Applied Sciences

Cover Photo: Adobe Stock

Centria. Raportteja ja selvityksiä, 36

ISBN 978-952-7173-39-8 (PDF)

ISSN 2342-933X

## **Authors involved:**

Agnieszka WALAK, IW Textile Research Institute, Poland  
Anita ILSKA, IW Textile Research Institute, Poland  
Antoni KOZIČ, Vilnius University of Applied Sciences, Lithuania  
Dana BELAKOVA, Riga Technical University, Latvia  
Donatas ŠAKALYS, Vilnius University of Applied Sciences, Lithuania  
Egidija RAINOSALO, Centria University of Applied Sciences, Finland  
Elżbieta MIELICKA, IW Textile Research Institute, Poland  
Eugenija STRAZDIENĒ, Vilnius University of Applied Sciences, Lithuania  
Eva LAPKOVSKA, Riga Technical University, Latvia  
Gunta ZOMMERE, Riga Technical University, Latvia  
Ilze BALTINA, Riga Technical University, Latvia  
Inga DABOLINA (Editor), Riga Technical University, Latvia  
Izabela JASIŃSKA, IW Textile Research Institute, Poland  
Janis DABOLINS, Riga Technical University, Latvia  
Jolanta JANICKA, IW Textile Research Institute, Poland  
Lidia NAPIERALSKA, IW Textile Research Institute, Poland  
Liene SILINA, Riga Technical University, Latvia  
Nghia Thanh NGUYEN, Centria University of Applied Sciences, Finland  
Romualda KOŹMIŃSKA, IW Textile Research Institute, Poland  
Tanvir AHMED, Centria University of Applied Sciences, Finland  
Teele PEETS, TTK University of Applied Sciences, Estonia  
Violeta JARZYNA, IW Textile Research Institute, Poland  
Violeta BYTAUTAITĒ, Vilnius University of Applied Sciences, Lithuania

## **Acknowledgments**

This research work was partially financed by the European Union's European Regional Development Fund, through the INTERREG BSR Programme, which awarded a grant to the SWW project (#Roo6). The authors gratefully acknowledge the received financial support.

Today the clothing industry in the EU is struggling against cheap imports from Asian countries. Production escaped to lowcost countries first from Sweden and Finland, and now the same is happening in the other Baltic Sea countries. Ergonomically designed, functional smart clothing and safe products are the competitive advantage in the competition against low priced import when trying to retain and develop business in the Baltic Sea Region (BSR). Latvia and Finland have specific knowhow in smart textiles and their applications in textiles and clothing, whereas Estonia, Latvia, Lithuania and Poland are the main producers in the Baltic Sea area. In these project industrial companies especially SMEs can benefit from the knowhow of modern scanner technology, smart clothing technology and effective supply chain management (i.e. RFID and PDM) of the universities. Transnational networks and knowhow of effective supply chains already exist between the SMEs in the BSR clothing field. However, there are possibilities in mass customization and new innovations, as well as in integrating IT technology in work wear clothing and building even more effective supply chains in the BSR.

The objective is to develop the work wear clothing business in BSR and make it more competitive in order to resist competition from new producers and imports. The supply chain is already transnational among BSR countries in the form of design, markets and subcontracting. The project focuses on mass customization, and the possibility to integrate IT technology in work wear as well as to enhance supply chain management.

Partners involved:

FINLAND	Centria University of Applied Sciences Ruuvi Innovations Oy
ESTONIA	TTK University of Applied Sciences AS Proflin
LATVIA	Riga Technical University SIA SRC Brasa
LITHUANIA	Vilnius University of Applied Sciences Ansell Protective Solutions Lithuania Ltd
POLAND	IW Textile Research Institute PW Krystian Sp. Zo.o.

# CONTENTS

INTRODUCTION .....	6
1. ANALYSIS OF TEXTILE MATERIALS FOR UPPER LEVEL PPE.....	7
1.1 Assessment of upper level fabric ....	7
1.2 Requirements for upper level fabrics .....	13
1.3 Selection of fabrics most suitable for upper level PPE .....	17
1.4 Results of testing the fabrics selected for Level 4 field uniforms and their analysis .....	24
1.5 Sewing thread analysis .....	35
1.6 Improvement of technological solutions .....	39
2. EXPERIMENTAL STUDY UNDERWEAR FABRICS .....	49
2.1 First level .....	49
2.2 Second level .....	53
2.3 Third level .....	56
3. DEVELOPMENT OF A NEW PROTOTYPE OF WORK WEAR .....	59
3.1 Workwear clothing prototype testing .....	61
3.2 Preparation of materials for testing and test results .....	63
3.3 Evaluation of test results .....	68
4. SURVEY OF EXISTING WEARABLE TECHNOLOGIES AND NEEDS OF END-USER SEGMENTS (IW, POLAND).....	73
4.1 Identification of hazards for employees in the construction industry .....	74
4.2 Innovative textronic solutions .....	75
4.3 Visibility level optimization .....	76
4.4 Heating clothes using electronic systems .....	76
4.5 Sensors monitoring the work environment .....	78
4.6 RFID communication system ....	79
4.7 Power supply.....	81
5. INTEGRATION OF SAFETY SENSORS INTO WORKWEAR .....	83
5.1 Safety sensors in workwear – development trends and innovations .....	84
5.2 Technical description of prototype .....	88
5.3 Description of the prototype development process and used materials .....	91
5.4 Testing of the prototype and analysis of the results.....	96
5.5 Conclusions, directions of the idea development .....	96
6. INCORPORATION OF ELECTRONICS INTO GARMENT BY 3D PRINTING .....	98
6.1 Materials and 3D printing method .....	98
6.1.1 Filament material .....	99
6.1.2 3D printing .....	100
6.2 Test methods of prints .....	101
6.2.1 Peeling test .....	101
6.2.2 Flexing test .....	102
6.2.3 Abrasion resistance test .....	103

6.3 Test results and discussions .....	105
6.3.1 Peeling test results .....	105
6.3.2 Flexing test results .....	107
6.3.3 Abrasion resistance test results .....	109
6.3.4 Washing test results .....	112
6.3.5 Surface roughness test results .....	115
6.3.6 Water absorption test results .....	119
6.3.7 Discussions .....	122
7. TO ENHANCE SAFETY AND WELLBEING OF FIREFIGHTER BY INCORPORATING ADVANCED WEARABLE ELECTRONICS INTO CHEMICAL PROTECTIVE CLOTHING CPC ..	124
7.1 Introduction .....	124
7.2 Chemical resistance of protective clothing .....	127
7.3 Types of protective materials .....	128
7.4 Requirements for European types of chemical protective clothing (CPC) .....	129
7.5 Components of chemical protective clothing (CPC) .....	130
7.6 Risk codes, phrases and pictograms of CPC .....	131
7.7 Fully Encapsulating CPC suit (Ansell company) .....	132
7.8 The assessment of CPC suits functionality by Lithuanian firefighters .....	134
7.9 1st prototype. Wireless communication module based on RF transmission .....	138
7.10 2nd prototype. Smart vest for firefighters health state and physiology monitoring ..	144
7.11 3rd prototype. The unit for remote surface temperature control .....	150
CONCLUSIONS .....	153
REFERENCES .....	155
ANNEXES .....	164

## INTRODUCTION

In order to ensure special protection for a workman against various types of risks that may occur during performance of the job/task, workwear sets and footwear are provided. Nowadays, tasks of the PPE include protection against environmental and manmade hazards, provision of comfort and preservation of human performance ability and life over a long period of time. The main trends in the design of workwear cover physiological monitoring, cold and heat protection, monitoring of chemical and biological protection, fire protection and protection against external environment hazards, as well as protection against various types of weapons. PPE must meet the requirements of the European Standards, the Cabinet Regulations and requirements of the respective company. Describing the specifics of workwear design, the following key factors in designing clothing systems can be addressed: protection, comfort, mobility (or ergonomics), connectivity (or compatibility) and ease of use (or functionality) [1].

Provisions, standards, and norms [2,3,4,5,6,7,8,9] determine labour protection requirements for the use of personal protective equipment – devices, equipment, systems, and products, including workwear and footwear to be worn or otherwise used by an employee to protect his or her safety and health from impact of one or more risk factors of the working environment. It is allowed to use only such protective equipment, which are designed and manufactured in accordance with the regulatory enactments regarding personal protective equipment and correspond to: risk factors of the respective working environment; working conditions; ergonomic requirements and health status of employees; peculiarities of the size of the employed individuals General functional requirements for workwear shaping guidelines for development of workwear to be designed can be summarized following review of the requirements of standards and also the general conditions of workwear design. Various tests are performed to verify these requirements - both tests of materials [8,10,11,12,13,14,15,16,17,18,19] and determination of performance of the built-in smart elements, as well as fit tests.

The research reflects the techniques for testing of PPE and the interpretation of results A study was conducted on four different end-user sectors: military, chemical workers, firefighters and builders.



# 1. ANALYSIS OF TEXTILE MATERIALS FOR UPPER LEVEL PPE

## 1.1. Assessment of upper level fabric

The analysis of Level 4 fabrics for field uniforms in the project was started with analysis of currently used fabrics. The said fabrics were supplied by the Carrington Company.

The analysis of fabrics used for trousers of field uniforms was based on the KIAS-MOD1\_fabric (Level 4) technical specification, the catalogue of the Carrington, testing report by the Latvian Certification Centre and the Institute of Design Technology (IDT). Two specimens of fabrics were tested: a specimen of the CP-21 fabric provided by the NAF and a specimen of the Harrier fabric sent by the Carrington Company. According to the oral statement of the Carrington Company, the CP-21 fabric was developed on the basis of the Harrier fabric, printed in accordance with the requirement of the Latvian National Armed Forces (NAF).

Table 1.1.  
A comparison of the structure and geometric characteristics of the Harrier field uniform fabric and the CP-21 fabric supplied within the procurement

Characteristics	Requirement of the technical specification	Indicated in the catalogue for the Harrier fabric	Harrier fabric IDT tested	CP-21 fabric IDT tested	CP-21 fabric LatSert tested
Fibre content	65% cotton 35% polyester	65% cotton 35% polyester	Not tested	Not tested	63.4±3% cotton 36.6±3% polyester
Type of fabric	Ripstop	Ripstop	Ripstop	Ripstop	Not specified
Width	1500mm±10%	150cm	155cm	149cm	Not tested
Mass of 1m <sup>2</sup>	200g	200g	217 ±11g	214±11g	214±11g
Warp density in the fabric	Not indicated	Not specified	413 threads/ 10cm	429 threads/ 10cm	Not tested
Weft density in the fabric	Not indicated	Not specified	228 thread/10cm	213 thread/10cm	Not tested
Warp linear density	Not indicated	Not specified	32.2 tex	32.8tex	Not tested
Weft linear density	Not indicated	Not specified	34.5tex	32.9tex	Not tested

Two structural characteristics are indicated in the technical specification of the fabric: fibre content and type of fabric. For both the Harrier fabric and the supplied C-21 fabric, these characteristics meet the requirement.

In addition, for both fabrics the following structural characteristics were determined by the Institute of Design Technology:

- warp density;
- weft density;
- warp linear density;
- weft linear density.

Comparison of the warp and weft density in both fabrics leads to a conclusion that these characteristics are different, which may be due to the different shrinkage of the fabrics during printing. Different fabric widths make us think of such a possibility.

Considering the potential unevenness of yarns, warp and weft linear densities are relatively close. Most likely, in both cases, yarn number 34 is used in both warps and wefts. Yarn of this number is also used in other Carrington branded field uniform fabrics (Delta, Teredo, Cooltex).

Two geometric characteristics are determined in the technical specification of the fabric: width of the fabric and mass of 1 m<sup>2</sup>.

The width of the fabric is indicated as 1500mm ± 10%, which means it can range from 135 to 165 cm. Such high amplitude can cause problems during the designing of garments, and, if the width of the fabric is as high as 135 cm, require additional material consumption. It should preferably be foreseen in the technical specification that the deviation from the average width does not exceed ± 5 cm and does not depend on average width (not expressed as a percentage of average width).

In the technical specification of the fabric, one constant value – 200 g/m<sup>2</sup> is indicated for the mass of 1m<sup>2</sup>. Actually, at the Latvian Certification Centre and the IDT, the value of 1m<sup>2</sup> of both fabrics is slightly higher. This discrepancy is so insignificant that it can be ignored.

Table 1.2.

A comparison of mechanical and physical characteristics of the Harrier field uniform fabric and the CP-21 fabric delivered within the procurement

Characteristic	Requirement of the technical specification	Indicated in the catalogue for the Harrier fabric	Harrier fabric IDT tested	CP-21 fabric IDT tested	CP-21 fabric LatSert tests
<b>Tensile strength:</b>					
• lengthwise	No more than 1050 N	950 N	1106±111 N	1260±126 N	1291±129 N
• crosswise	No more than 450 N	450 N	552±55 N	547±55 N	547±55 N
<b>Elongation at break:</b>					
• lengthwise	Not specified	Not specified	22.2 %	15.5 %	Not tested
• crosswise			11.7 %	12.7 %	
<b>Tear strength:</b>					
• for warps	Not specified	30 N	27 N	19 N	Not tested
• for wefts		22 N	20 N	15 N	
<b>Air permeability (at pressure difference 100 Pa):</b>					
	No less than 150 mm/s	Not specified	60 mm/s	30 mm/s	22±4 mm/s
<b>Flexural rigidity:</b>					
• lengthwise	0.7 - 2.4	Not specified	17 µNm	18 µNm	Not tested
• crosswise			23 µNm	49 µNm	
<b>Abrasion resistance:</b>					
	Not specified	25 000 cycles (9 kPa)	30 000 cycles (12 kPa)	30 000 cycles (12 kPa)	Not tested
<b>Surface impermeability:</b>					
	Not specified	Not specified	1 point	4 points	Not tested
<b>Thermal resistance:</b>					
	Up to 0.02 m <sup>2</sup> Pa/W	Not specified	<0.02 m <sup>2</sup> Pa/W	<0.02 m <sup>2</sup> Pa/W	Not tested
<b>Water vapour resistance:</b>					
	Up to 3.5 m <sup>2</sup> K/W	Not specified	3.4 m <sup>2</sup> K/W	4.2 m <sup>2</sup> K/W	Not tested

The following requirements for mechanical and physical characteristics are determined in the technical specification of the fabric:

- tensile strength lengthwise and crosswise;
- air permeability;
- flexural rigidity;
- dimensional changes;
- water vapour resistance;
- thermal resistance;
- vapour permeability index.

Mechanical and physical characteristics additionally determined by the IDT:

- relative elongation;
- tear strength;
- durability;
- surface impermeability.

The tensile strength indicators, both lengthwise and crosswise, correspond to the ones determined by the technical specification. It should be taken into account that the technical specification indicates very different tensile strength values. Basically, the tensile strength crosswise is very low and is not suitable for the field uniform also worn during active physical loads. The tensile strength has been tested in accordance with the standard EN ISO 13934-1:2003 [11]. The standard method for determining the tensile strength determines the absolute elongation of the fabric and calculates the relative elongation. Consequently, determination of these indicators does not require much additional work or resources, while providing information on the maximum elongation of the fabric at break and the freedom of movement during wearing. The relative elongation values set by the IDT laboratory indicate the low elongation of the fabric. “Recommendation Concerning Characteristics And Faults In Fabrics To Be Used For Clothing” recommended by the European Clothing and Textile Confederation EURATEX [20] advises that elongation of trouser fabric should be within the scope from 12.5 to 55% in each direction. For the CP-21 fabric, this value is close to the minimum value, but for the Harrier fabric crosswise it is even lower than the minimally allowable value.

In this case, it can be concluded that from the point of view of elongation, the fabric is not suitable for active physical loads, when garments are subject to high tensile deformation.

The tear strength of the two investigated fabrics was determined at the laboratory of the IDT. The resulting values are low. If they match the ones indicated in the catalogue, they could still be considered almost satisfactory. Unfortunately, the actual tested values are lower than those specified in the catalogue.

The air permeability of the CP-21 fabric is at least 5 times lower than required by the technical specification. Such air permeability is not permissible for clothing worn during heavy load in summer time.

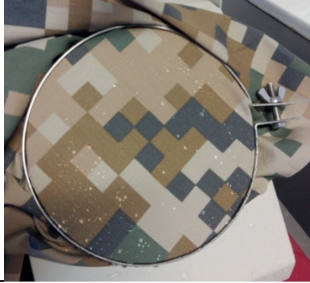

The range of rigidity values specified in the technical specification of the fabric is unclear and no measurements of this characteristic are also given. At the IDT laboratory, the flexural rigidity lengthwise and crosswise was determined for both fabrics, the Harrier and the CP – 21, using the standard BS 3356 [21] and the same equipment intended for use in the method of the standard ASTM D1388 [22]. For the CP-21 fabric, the rigidity crosswise was significantly increased (more than 2 times) compared to the Harrier fabric. It is too high for fabrics of this type of clothing and such a fabric may be unpleasant in contact with the wearer's skin.

The technical specification of the fabric does not specify the abrasion resistance of the fabric, which would let us judge on the length of wearlife of the product. The Carrington Company's electronically available description of the Harrier fabric shows that its durability under abrasion is 25,000 cycles at a pressure of 9 kPa. This value indicates a fairly short wearlife. "The Recommendation Concerning Characteristics and Faults in Fabrics To Be Used for Clothing" developed by the European Clothing and Textile Confederation EURATEX recommends that the fabric for everyday trousers should withstand at least 20,000 rubbing cycles at the pressure of 9 kPa [20]. Consequently, the durability value indicated by the Carrington Company for this fabric is very close to the minimum. In addition, field uniforms should be regarded as technical textiles, for which, according to the standard EN ISO 12947 – 2:2016 [12], the durability should be determined at the pressure of 12kPa, which theoretically reduces the number of rubbing cycles that have withstood until the breaking.

In the IDT laboratory, the surface impermeability was tested for both fabrics. The results of the fabrics are very different. If the surface of the Harrier fabric moistens heavily and the impermeability scored 1 point, then the surface of the CP-21 fabric has become almost water-repellent and scored 4 points (see Table 1.3.).

Table 1.3

### Water impermeability of the fabrics

Name	CP21	Harrier
<i>Test results</i>		
<i>Result</i>	4 points Surface of the specimen moistened in some points	1 points The specimen has become completely wet

The water vapour resistance of the Harrier fabric corresponds the values specified in the technical specification, while the water vapour resistance of the delivered CP-21 fabric is higher than specified. Consequently, during physical activities in warm weather the fabric increasingly accumulates humidity in the underwear layer. As a result, the fabric sticks to the body and does not withstand the additional stresses – it tears apart.

The reason for the breakdown of the trouser fabric is largely due to its low water vapour permeability and low tear strength.

1) Compliance of the CP-21 fabric with the technical specification:

- a. the width is in accordance with the technical specification;
- b. the fibre content conforms to the technical specification;
- c. the mass of 1m<sup>2</sup> does not differ significantly from the technical specification;
- d. the type of fabric and interweaving conforms to the technical specification;
- e. tensile strength both lengthwise and crosswise conforms to the technical specification;
- f. no assessment can be made on the fabric's conformity to its flexural rigidity, because

the requirement is incomprehensible;

g. the water vapour resistance of the delivered fabric is higher than the one indicated in the technical specification and therefore it does not conform to it.

***Conclusion: The CP-21 fabric does not conform to the technical specification KIAS-Mod1-fabric (level 4) and is also unsuitable for field uniforms.***

2) In development of a new technical specification, the following should be taken into account:

- a. It is desirable to foresee deviation from the average width no more than  $\pm 5$  cm and not dependent on the average width (not expressed as a percentage of the average width).
- b. When specifying mass of  $1\text{m}^2$ , not just one specific value should be specified but a permissible range;
- c. In order to more precisely define the structure of the fabric, it is desirable to think about inclusion of additional structural characteristics – the warp and the weft density, in the specification;
- d. The minimum value of tensile strength of the fabric crosswise should be increased;
- e. In addition, the technical specification should include the relative elongation of the fabric at break;
- f. The technical specification must additionally include the tearing strength;
- g. The requirement for flexural rigidity of the fabric should be revised, as it is currently incorrectly indicated in the technical specification;
- h. The technical specification should additionally include the requirement for abrasion resistance.

## 1.2. Requirements for upper level fabrics

General requirements for protective clothing are summarized in the standard EN ISO 13688:2013 “Protective clothing. General requirements” [2]. This standard defines general requirements for protective clothing regarding ergonomics, safety, sizing, aging, compatibility, marking, and provides guidance on the information to accompany the product. General physical and mechanical requirements for protective clothing are summarized in Table 1.4.

Table 1.4.

**Requirements for protective clothing in line with EN 340:2003**

Characteristic	Standard	Requirement
pH of the material of protective clothing	EN ISO 3071 (the standard for materials other than leather) [23]	$>3.5$
Colour fastness due to sweat	EN ISO 105-A02 [24]	$\geq 4$
Dimensional changes after dry cleaning	EN ISO 3175-1 [25]	$\pm 3\%$
Dimensional changes after washing (5 washing cycles)		
	ISO 5077:2007 [15]	$\pm 3\%$

As the fabric of field uniform should be partially fire-proof, the study takes into account requirements of the standard EN 469:2014 “Protective clothing for firefighters. Performance

requirements for protective clothing for firefighting” [26]. The requirements for fabrics for firefighters are summarized in Table 1.5.

Table 1.5

**Requirements for fabrics for firefighting in line with EN 469**

Property		Standard	Requirement
Tensile strength		EN ISO 13934-1 [11] EN ISO 1421 [27]	In both directions $\geq 450\text{N}$
Seam strength		EN 13935-2 [28]	$\geq 225\text{ N}$
Tear resistance:	For coated fabrics	EN ISO 4674-1 [29]	$\geq 25\text{ N}$
	For fabrics without coating	EN ISO 4074-1 [29]	
Dimensional changes		ISO 5077 [15]	$\leq 3\%$
Resistance to surface wetting		EN 7920 [13]	$\geq 4$
Waterproofness		EN ISO 811 [30]	$< 20\text{kPa}$

Requirements for workwear developed by the European Textile Service Association (ETSA) [31] are summarized in Table 1.6 specifying requirements to be met by each textile manufacturer, according to the recommendations of the Association. In line with these requirements, material quality is ensured. The requirements apply to fabrics containing fibres consisting of a mixture of cotton and polyester fibres and a minimum percentage of polyester of 30%.

Table 1.6

**Requirements for cotton/polyester workwear fabrics**

Characteristic	Standard	Requirement
----------------	----------	-------------








Mass of 1m <sup>2</sup> , g	ISO 3801 [32]	150 – 400 g/m <sup>2</sup> Maximum deviation for fabrics with surface density < 230 g/m <sup>2</sup> is +/- 5 %	
	Method 5	Maximum deviation for fabrics with surface density ≥ 230 g/m <sup>2</sup> + 5 % /- 4 %	
Dimensional changes	ISO 5077 [15]	After 5 cycles (washing and drying)	
		< 50 % Cotton	max +/- 2.0 %
Pilling (for fabrics containing more than 50 % of polyester fibres)	ISO 12945-2 [33]	After 5000 rubbing cycles - Point: 5.0	After 5 washing- drying cycles and 5000 rubbing cycles Point: 3.5
		Lengthwise and crosswise	
Tensile strength	ISO 13934 [11]	< 50 % Cotton	≥ 2 N /(g/m <sup>2</sup> ) min 400 N
		≥ 50 % Cotton	≥ 1.8 N /(g/m <sup>2</sup> ) min 380 N
Appearance assessment after washing and drying	ISO 15487 [34]	After 3 cycles (washing/ drying)	
		< 50 % Cotton	≥ Point 3.5
Colour fastness to washing	ISO 105-C06 [17]	Staining	Colour loss
		≥ 4 - 5 points	≥ 4 points
Colour fastness to bleaching (hypochlorite)	ISO 105-N01 [35]	≥ 4 points	
Colour fastness in water	ISO 105-E01 [36]	≥ 4 - 5 points	
Colour fastness under artificial light (Xenon lamp)	ISO 105-B02 [37]	≥ 5.0 points	

Taking into account the wear-and-tear nature of trousers worn by soldiers of the NAF, the information on technical parameters provided by these fabric manufacturers, the physical and mechanical properties of the fabrics of field uniforms tested during the project, and the requirements for fabrics of field uniforms of the Latvian National Armed Forces are summarized in Table 1.7.

Table 1.7.

### Requirements for the NAF's Level 4 field uniform fabrics

Characteristic	Determination method	Values
Type of fabric		Rip-stop fabric
Fibre content	Regulation (EU) No 1007/2011 of the European Parliament and of the Council [38]	50 ± 3% cotton 50 ± 3% polyamide (cordura or equivalent)
Weaving		Canvas
Warp density	EN 1049-2 [39]	390 threads/10cm ± 3%
Weft density	EN 1049-2 [39]	215 threads/10cm ± 7%
Type of warp		Cable-laid yarn
Warp linear density	ISO 7211-5 [40]	From 13.5x2 to 16 tex x 2
Type of weft		Cable-laid yarn
Weft linear density	ISO 7211-5 [40]	38.5 tex ± 5%
Width	EN 1773 [41]	No less than 150 cm
Mass of 1m <sup>2</sup>	EN 12127 [42] or ISO 3801 [32]	230 ± 20g/m <sup>2</sup>
Tensile strength:		
• lengthwise	EN ISO 13934-1 [11]	No less than 1000N
• crosswise		No less than 750N
Relative elongation at the moment of breaking:		
• lengthwise	EN ISO 13934-1 [11]	No less than 25 %
• crosswise		No less than 18 %
Tear strength:		
• for warp	EN ISO 13937-2 [10]	No less than 30 N
• for weft		No less than 30 N
Durability under abrasive rubbing	EN ISO 12947-2 (nominal pressure 12kPa) [12]	No less than 250 000 cycles
Dimensional changes after 5 washing cycles at 60°C and drying in a tumble dryer:		
• lengthwise	EN ISO 5077 [15]	No less than 2%
• crosswise	EN ISO 6330 [14]	No less than 2%
Pilling (after 7000 cycles)	EN ISO 12945-2 [33]	No less than 4 – 5 points
Air permeability at 100Pa	EN ISO 9237 [43]	No less than 40 mm/s
Water vapour resistance	EN ISO 11092 [16]	No less than 4 m <sup>2</sup> · Pa/W
Colour fastness due to light	EN ISO 105-B02 [37]	No less than 5 points
Colour fastness to washing at 60°C	EN ISO 105-C06 [17]	No less than 4 points
Colour fastness to dry cleaning	EN ISO 105-D01 [44]	No less than 4 points

Characteristic	Determination method	Values
Colour fastness:		
• to dry rubbing	EN ISO 105-X12 [18]	No less than 4 points
• to wet rubbing		No less than 4 points
Colour fastness due to sweat:		
• in acidic condition	EN ISO 105-E04 [19]	No less than 4 points
• in alkaline condition		No less than 4 points
Colour fastness to pressing	EN ISO 105-X11 [45]	No less than 4 points
Resistance to surface wetting (for new – unwashed fabric)	EN ISO 4920 [13]	No less than 5 points
Resistance to surface wetting after 5 washing cycles in 60°C and drying in a dryer	EN ISO 4920 [13]	No less than 3 points
Oil repellency	EN ISO 14419 [46]	No less than 5
Oil repellency after 5 washing cycles at 60°C and drying in a tumble dryer	EN ISO 14419 [46]	No less than 4
Protection against liquid chemicals:	EN ISO 6530 [47]	
• impermeability index		No less than 94%
• permeability index		No less than 1%
• absorbency index		No less than 8%
Flame spread during burning – surface and bottom-edge flammability	EN ISO 15025 [48]	Does not flame up and does not create melting drops
<hr/>		
Care:		
• washing		Machine washable in 60°C 
• bleaching		Must not be bleached 
• tumble drying		May be tumble dried at a maximum of 60°C 
• ironing	EN ISO 3758 [49]	May be ironed. Maximal ironing temperature 150°C 
• dry cleaning		May be dry cleaned with tetrachloroethylene and all solvents corresponding to the symbol F 

### 1.3. Selection of fabrics most suitable for upper level PPE

Since to this day the Carrington fabric has been used to sew field uniforms for the NAF, the information was first summarized about all of the fabrics with masking print manufactured by the Company. Information provided in the catalogue is summarized in Table 1.8. According to the table, the Company produces fabrics containing cotton and polyester fibres in different

proportions. To this day, uniforms of the NAF are sewn from the Harrier fabric. Looking at its technical parameters, it can be concluded that this fabric is one of the worst in terms of mechanical strength and abrasion resistance, which largely explains the short wearlife of the uniforms. The Python fabric shows highest mechanical performance. This is most likely due to the high content of polyester fibres in the fabric, which could potentially deteriorate hygienic properties.

The study also examines fabrics of field uniforms produced by Andropol and TenCate, as well as NYCO and PUMA fabrics produced by various companies such as Čateks, Kipas, Lauffenmühle GmbH & Co. K.G., Greenside Klopman et al., as well as elastic fabrics suitable for field uniforms produced by various companies.

For the Andropol fabrics, basic information on the fibre content and finish was available. The company was asked to provide more information about the fabrics, after which they sent samples of fabrics for which mechanical and physical properties were determined. The results obtained are summarized in Table 1.9.

The TenCate manufactures fireproof fabrics suitable for fire-resistant field uniforms.

Table 1.8

Summary of the Carrington fabric assortment

Product name	Interweaving	Content	Mass of 1m <sup>2</sup> , g	Tensile strength (N)		Tear strength (N)		Abrasion resistance (cycles)	Dimensional changes %		Fibre density per 1cm		Colour fastness	
				lengthwise	crosswise	lengthwise	crosswise		lengthwise	crosswise	warp	weft	Dry rubbing	Wet rubbing
TEREDO	Twill 2/1	CO 35%, PES 65%	195	1150	650	35	30	45000	2	2	40	24	4	3
HARRIER	Fabric with Ripstop	CO 65%, PES 35%	200	950	450	30	22	25000	2	2				
RAPTOR	Twill 2/2 with Ripstop	PA 12%, CO88 %	200	1100	680	80	60	15000	5	5				
SPARTAN	Fabric with Ripstop	PA 50%, CO 50%	210	850	350	35	20	70000	3	3				
DELTA	Twill 2/1	CO35%, PES 65%	210	1250	620	42	32	45000	2	2	45	22	4	3
ULTRA	Twill 2/1	CO50%, PES 50%	215	900	700	35	30	30000	2	2	44	22	4	3
COOLTEX1	Sateen 4/1	CO50%, PES 50%	215	1150	600	30	25	45000	3	3	54	31	4	3
PYTHON	Twill 3/1	CO 30%, PES 70%	235	1250	1100	45	40	80000	2,5	2,5	43	27	4	3
TOMBOY	Twill 2/1	CO 35%, PES 65%	245	1400	800	45	43	50000	2	2	34	21	4	3
TROY	Twill 2/1	CO 60%, PES 40%	245	1050	550	32	27	40000	2	2	34	21	4	3
COOLTEX3	Sateen 4/1	CO 50%, PES 50%	275	1700	700	47	32	55000	3	3	51	26	4	3

Table 1.9.

## Experimentally obtained results of the “Andropol” fabric

	Andr-1	Andr-2	Andr-3	Andr-4	Andr-5
<b>Geometric characteristics</b>					
Width (m)	1.58	1.48	1.48	1.58	1.47
Thickness (mm)	0.46	0.44	0.39	0.44	0.43
Mass of 1 m <sup>2</sup> , g	228	200	213	229	228
<b>Structural characteristics</b>					
Fibre content	PA50, CO50	PA50, CO50	PES15, CO85	PA50, CO50	PES50, CO50
Interweaving	Ripstop fabric	Ripstop fabric 2/2	Ripstop twill – 2/2	Ripstop fabric	Ripstop fabric
Yarn density (yarn/ 10 cm)	weft	204	312	204	180
	warp	292	402	598	304
Yarn linear density (Tex)	weft	41.8	31.4	21.8	40.4
	warp	42.7	31.6	19.4	40.6
Number of yarns (m/g)	weft	23.9	31.9	45.9	24.8
	warp	23.4	31.7	51.6	24.7
<b>Tensile strength (mean values)</b>					
Load (N)	lengthwise	1155	1192	1439	1168
	crosswise	805	515	733	796
<b>Elongation at break</b>					
Elongation (%)	lengthwise	44	27	17	41
	crosswise	28	18	21	28
<b>Air permeability at pressure difference 100 Pa</b>					
Air permeability coefficient (mm/s)	26	95	94	26	106
<b>Colour fastness at dry and wet wear</b>					
Dry rubbing (points)	lengthwise	4-5	4-5	4-5	5
	crosswise	4-5	4-5	4-5	4-5
Wet wear (points)	lengthwise	4	4	3-4	4-5
	crosswise	4	4	4	4

Table 1.10.

## Summary of the „TenCate” fabric assortment

		Defender M				
		DM 9180	DM 9210	DM 9190	Laminated waterproof materials	
					DM 9180 with Hydro-Control™	DM 9180 with Hydro-Control™ triple
Width (cm) (+2/-1 cm)		163	163	163	150	150
Mass of 1m <sup>2</sup> , g (±5%)		180	210	190	230	280
Interweaving		2/1 twill	Ripstop fabric	Ripstop fabric	2/1 twill	2/2 twill
Content		Lenzing FR®/ aramid/ PA/ antistatic fibres	Lenzing FR®/ aramid/ PA/ antistatic fibres	Lenzing FR®/ aramid/ PA/ antistatic fibres	Lenzing FR®/aramid/ PA/ antistatic fibres + ePTFE/PU BI-component membrane	Lenzing FR®/aramid/PA/ antistatic fibres + ePTFE/PU BI-component membrane +knit fabric FR-Knitt
Tensile strength (N)	lengthwise	750	900	1400	900	900
	crosswise	650	800	1100	650	650
Dimensional changes		± 3%	± 3%	±3%	±3%	±3%
Thermal resistance to 180°C temperature		± 5% shrinkage. Does not melt and catch fire	± 5% shrinkage. Does not melt and catch fire	± 5% shrinkage. Does not melt and catch fire	± 5% shrinkage	± 5% shrinkage
Durability 12 kPa (cycles)		50000	50000	100000	80000	80000
Water vapour resistance (m <sup>2</sup> Pa/W)					< 7	< 10
Tear strength (N)	lengthwise	45	35	95		
	crosswise	40	35	90		
Air permeability 100Pa (L/m <sup>2</sup> /s)		> 300	> 120	> 200		
Finishes available		Hydro-Tec	Hydro-Tec	Hydro-Tec		Hydro-Control™ triple

Both the Andropol and TenCate fabrics have mechanical properties very similar to the mechanical properties of the Carrington fabrics. As disadvantage of the Andropol fabrics, the low air permeability could be noted, while for the TenCate fabrics – the relatively high dimensional changes in washing.

The PUMA and NYCO fabrics are made of cotton and polyamide in various proportions. Mostly, this ratio is 50:50%, but there are also fabrics with 75% cotton and 25% Polyamide.

Table 1.11. shows technical data of various NYCO and PUMA fabrics.

Table 1.11.

**Technical data of NYCO and PUMA fabrics**

		<b>NYCO 380</b>	<b>PUMA 240</b>	<b>PUMA 220</b>
Fibre content		CO75%/PA25%	CO50%/PA50%	CO50%/PA50%
Type of fabric		Fabric with rip stop	Fabric with rip stop	Fabric with rip stop
Mass at 1m <sup>2</sup> , g		380	240	220
Tensile strength (N)	lengthwise	1094	1100	1000
	crosswise	569	800	750
Relative elongation (%)	lengthwise		25	25
	crosswise		15	15
Tear strength (N)	lengthwise		≥ 30	≥30
	crosswise		≥ 30	≥30
Durability (cycles)		250000	≥ 300000	≥ 250000
Dimensional changes after 5th washing cycle 60°C	lengthwise		-2 %	-2 %
	crosswise		-2 %	-2 %
Water vapour resistance, m <sup>2</sup> Pa / W			< 5	< 5
Colour fastness in dry wear			≥ 4	≥ 4
Colour fastness in wet wear			≥ 4	≥ 4
Colour fastness in washing			≥ 4	≥ 4
Air permeability (100 Pa) mm/s			≥ 20	≥ 45



These fabrics show fairly good mechanical properties, as well as very high durability. These fabrics meet the originally set requirements. Consequently, PUMA 240 and PUMA 220 fabrics were preferred as potentially the best ones for field uniforms.

During the project, studying the reasons for wear-and-tear of trousers, it was concluded that the freedom of movement could be improved by fitting an elastic fabric in the crotch of trousers. Consequently, the project studied various types of elastic fabrics as a potential auxiliary material. Available information on these fabrics is summarized in Table 1.12.

Table 1.12.

**Summary on assortment of elastic auxiliary materials**

		<b>Bliss</b>	<b>Monte</b>	<b>Brest</b>	<b>Schoeller Nr.81029</b>	<b>Defender M Stretch</b>
Fibre content		90% PA (54% Cordura®); 9,6% Elastane; 0,4 Antistatic fibres	94% PA Cordura®; 6% Elastane	93% PA Cordura®, 7% Elastane	90% PA, 10% Elastane	65% VI, 25% PPTA, 10% PA
Mass of 1m <sup>2</sup> , g		165	260	210	240	210
Tensile strength (N)	lengthwise	700	2000	1050	1000	610
	crosswise	1150	1200	850	1000	390
Elongation at break %	lengthwise	90	50	100	75	
	crosswise	85	100	80	80	
Tear strength (N)	lengthwise	25	150	40	70	53
	crosswise	50	100	40	125	42
Durability (cycles)		200 000	150 000	80 000		
Washing temperature		40°C	40°C	40°C	60°C	60°C
Dimensional changes					+1/-3%	

Of all the elastic fabrics, Schoeller and DefenderM Stretch fabrics were selected for further research because they were available at the company SRC Brasa. Obtainment of other fabric samples was unsuccessful.

#### 1.4. Results of testing the fabrics selected for Level 4 field uniforms and their analysis

The following characteristics have been experimentally determined for fabrics selected for Level 4 field uniforms:

- Thickness, in line with the standard EN ISO 5084 “Textiles – Determination of thickness of textiles and textile products” [50];
- Mass of 1m<sup>2</sup>, in line with the standard EN 12127 “Textiles. Fabrics. Determination of mass per unit area using small samples” [42];
- Dimensional changes, in line with the standard EN ISO 5077 “Textiles. Determination of dimensional change in washing and drying” [15] and EN ISO 6330 “Textiles. Domestic washing and drying procedures for textile testing” [14]. Washing was done at 60° C in a washing machine in normal operation, but the samples were dried both in a tumble dryer at 60°C and at room temperature;
- The tensile strength and elongation of the fabric are determined in line with the standard EN ISO 13934-1 “Textiles. Tensile properties of fabrics. Part 1: Determination of maximum force and elongation at maximum force using the strip method” [11]. The initial distance between grippers is 200 mm and the speed of grippers is 100mm/min. Initial stretch is 5N;
- The abrasion resistance was determined in line with the standard EN ISO 12947-2 “Textiles. Determination of the abrasion resistance of products by the Martindale method. Part 2: Determination of specimen breakdown” [12]. Abrasive is applied to the investigated material at a constant pressure of 12 kPa. Rubbing occurs until the woven fabrics have two separate threads torn;
- The colour fastness was determined in line with the standard EN ISO 105-X12 “Colour fastness to rubbing” [18];
- The air permeability of the garments was determined in line with standard EN ISO 9237 “Textiles. Determination of the permeability of fabrics” [43]. The test sample area is 5 cm<sup>2</sup>, the air pressure difference on both sides of the fabric 100Pa.
- The water vapour resistance was determined in line with the standard EN ISO 11092 “Textiles. Physiological effects. Measurement of thermal and water-vapour resistance under steady-state conditions (sweating guarded-hotplate test)” [16].

The geometric characteristics of the tested fabrics are summarized in Table 1.13. For both PUMA fabrics – the mass of 1m<sup>2</sup> of both PUMA 220 and PUMA 240 is lower than indicated

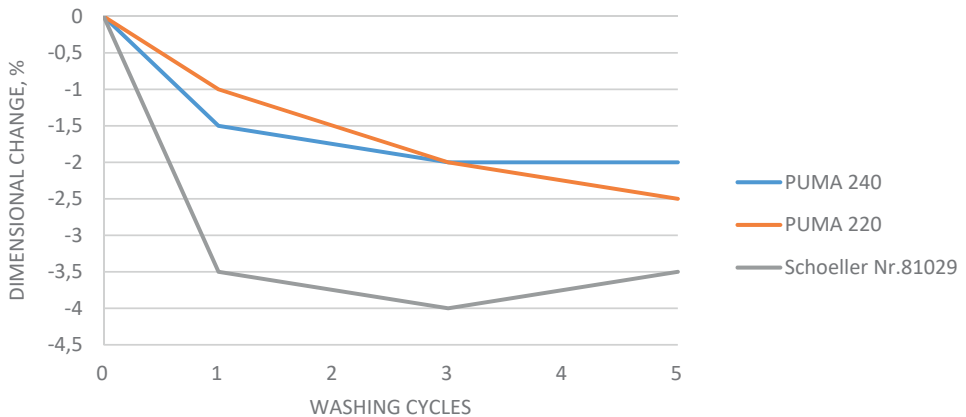
by the manufacturer. For PUMA 220 it is 213g/m<sup>2</sup>, but for PUMA 240 – 219g/m<sup>2</sup>, which differs from numbers indicated by the manufacturer by more than 5%. For the Schoeller No. 81029, the mass of one square meter is 255g/m<sup>2</sup>, which is a significant difference in fabrics that must be combined in one product. Also, in terms of thickness, the Schoeller No. 81029 is 1.8 times thicker than the PUMA 220.

Table 1.13.

**Geometric characteristics of fabrics**

	<b>PUMA 220</b>	<b>PUMA 240</b>	<b>Schoeller No 81029</b>	<b>Defender M Stretch</b>
Thickness, mm	0,40	0,44	0,73	0,49
Mass of 1 m <sup>2</sup> , g	213	219	255	207

The fabrics were washed 5 times at 60° C, some of the specimens were dried at room temperature, and some – in a tumble dryer at 60° C. The Schoeller No. 81029 care instructions do not allow tumble drying.



*Figure 1.1. Dimensional changes lengthwise after washing at 60°C*

For the fabrics PUMA 220 and 240, dimensional changes lengthwise after 5 washing cycles and drying at room temperature (Fig.1.1.), the dimensional changes lengthwise are 2.5% and 2% respectively, but for the Schoeller No. 81029 – 3.5%.

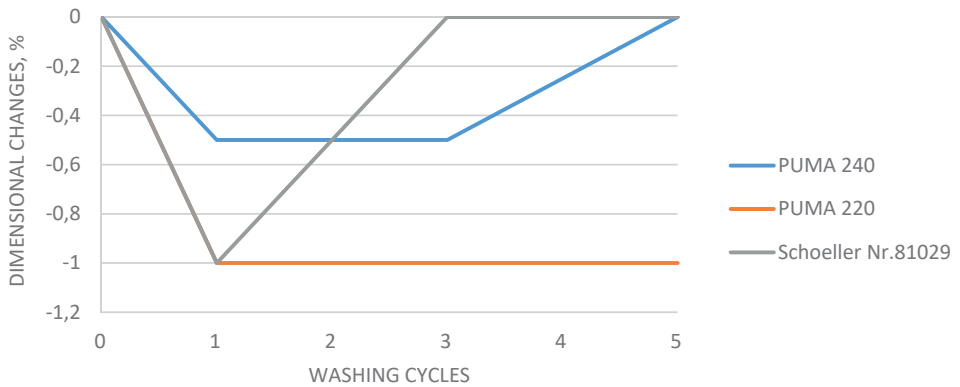


Figure 1.2. Dimensional changes crosswise at 60°C

After the fifth cycle, when the materials were washed at 60°C and dried at room temperature (Fig.1.2), the PUMA 240 and Schoeller No. 81029 fabrics returned to their original size, while the PUMA 220 fabric shrunk by 1%.

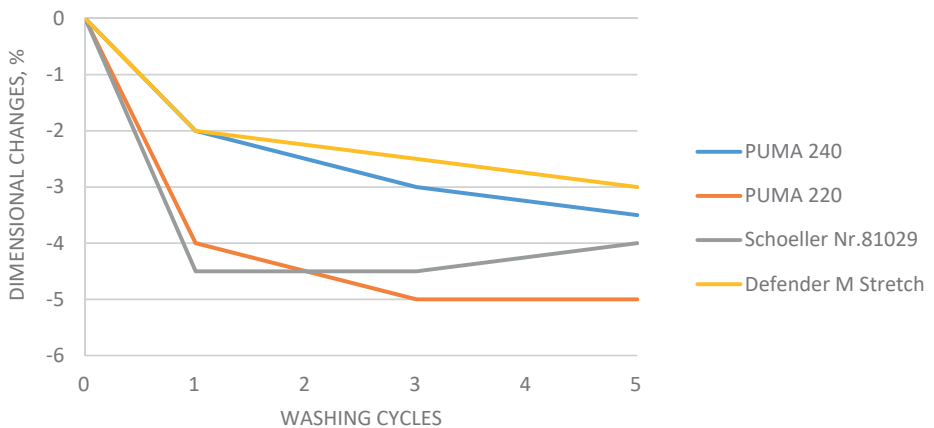


Figure 1.3. Dimensional changes after washing and drying at 60°C

Fig.1.3. shows dimensional changes lengthwise of fabrics after 5 washing and drying cycles at 60°C. According to the results, the PUMA 220 fabric has shrunk by 5%, the PUMA 240 – by 3,5 %, the Schoeller No 81029 by 4%, and the Defender M Stretch – by 3%.

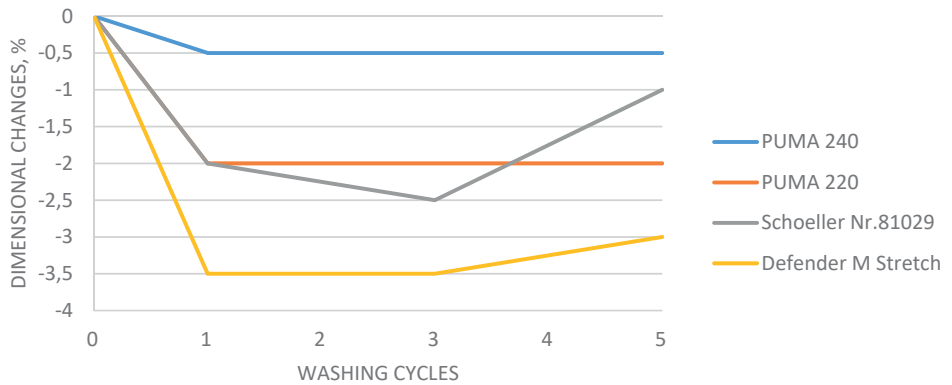


Figure 1.4. Dimensional changes crosswise after washing and drying at 60°C

Fig.1.4 shows dimensional changes crosswise after 5 washing and drying cycles at 60°C, where the PUMA 220 and 240 fabrics have shrunk by 2% and 0.5%, respectively. While the Scholler No. 81029 and the Defender M Stretch – by 1% and 3%.

Table 1.14.

Summary on dimensional changes

	Washing and drying at room temperature				Washing and drying at 60°C			
	1 washing cycle		5 washing cycles		1 washing cycle		5 washing cycles	
	lengthw	crossw	lengthw	crossw	lengthw	crossw	lengthw	crossw
PUMA 220	-1.0	-1.0	-2.5	-1.0	<b>-4.0</b>	-2.0	<b>-5.0</b>	-2.0
PUMA 240	-1.5	-0.5	-2.0	0.0	-2.0	-0.5	<b>-3.5</b>	-0.5
Schoeller No 81029	<b>-3.5</b>	-1.0	<b>-3.5</b>	0.0	<b>-4.5</b>	-2.0	<b>-4.0</b>	-1.0
Defender M Stretch	-	-	-	-	<b>-3.5</b>	-2.0	-3.0	-3.0

Test results lead to a conclusion that the Schoeller No. 81029 may not be washed at 60°C because it shrinks lengthwise by 3.5%, but by 4% when it is dried at elevated temperature. The PUMA 220 and PUMA 240 materials shrink within the normal range, if they are not dried at

elevated temperatures, but when dried in a tumble dryer, their shrinkage lengthwise is 3.5% and 5%, respectively, thus exceeding the permissible limits. Table 1.14. that shows summary of technical characteristics given by the manufacturer for the PUMA 220 and PUMA 240 fabrics, reveal that the shrinkage lengthwise and crosswise must not exceed 2%, which means that the actual values do not correspond to those indicated by the manufacturer. The Defender M Stretch fabric can be washed at 60°C and dried at 80°C according to the care instructions provided by the manufacturer but drying already at 60°C leads to shrinkage of the fabric by 3%. Shrinkage by 3.5% means that the product loses about 1 size, which significantly affects the wearlife of trousers.

Tensile strength at break determined for 3 types of specimens – unwashed fabrics, fabrics washed 5 times at 60°C and fabrics dried at room temperature and fabrics that were washed 5 times and dried at 60°C.

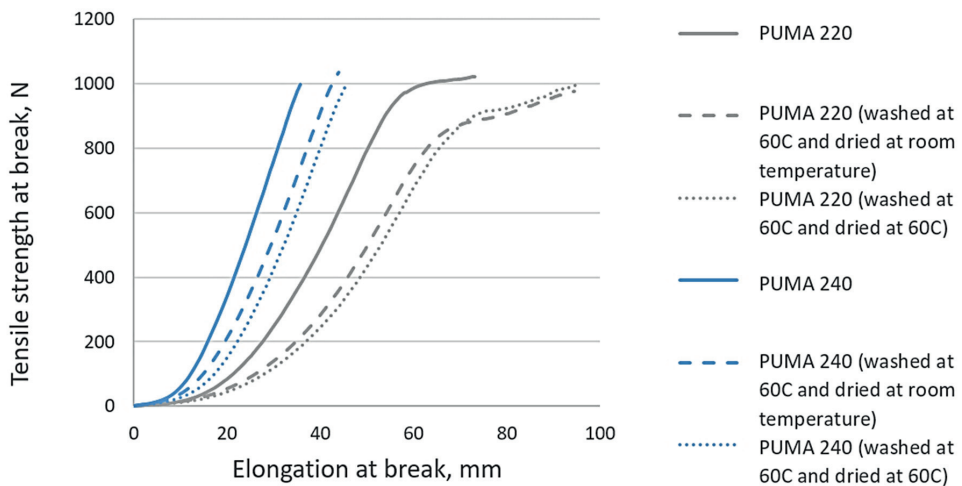


Figure 1.5. Tensile strength at break of PUMA 220 and PUMA 240 fabrics lengthwise

Fig.1.5. shows tensile strength at break of the PUMA 220 and 240 fabrics, which is very similar in both fabrics, the elongation of the fabric PUMA 220 is higher – 37%, while of the PUMA 240 it is 24%. After washing and drying, the elongation of fabrics increases which can be explained by the fact that weft and warp density of the fabric increases because of shrinkage in washing.

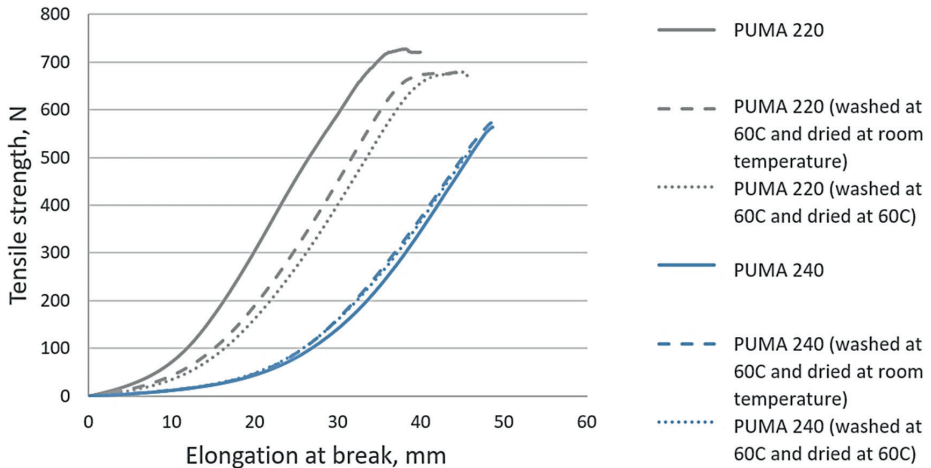


Figure 1.6. Tensile strength of PUMA 220 and PUMA 240 fabrics crosswise

Fig.1.6. shows that the PUMA 240 fabric has better elongation crosswise, but its tensile strength is only 560N, although it should be 750N according to the specification. The tensile strength of the PUMA 240 fabric crosswise is much lower than indicated in the specification; this value could be the reason, why trousers tear in crotch area under dynamic loads.

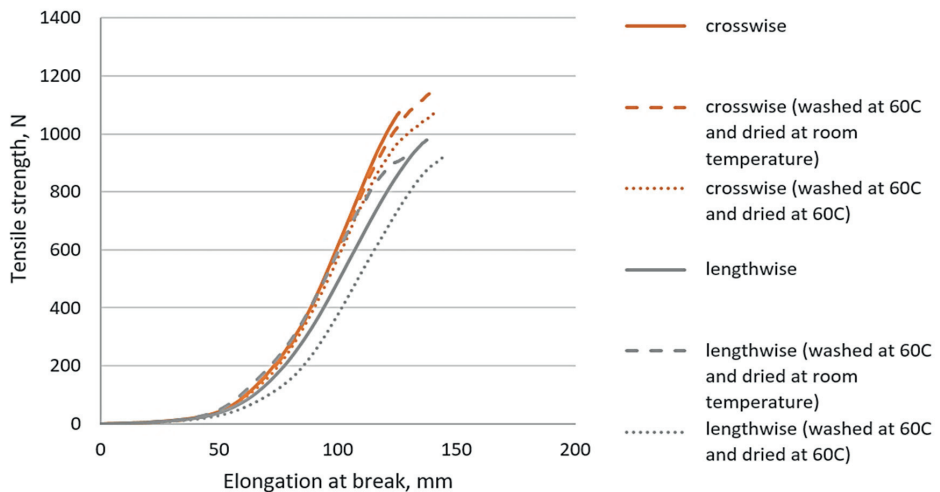


Figure 1.7. Tensile strength of Schoeller No 81029

The size of the Schoeller No. 81029 specimen is 100x50 mm, taking into consideration its high elongation (~135%). The fabric is elastic both lengthwise and crosswise, which explains its high elongation ability and tensile strength in both directions (Fig.1.7.).

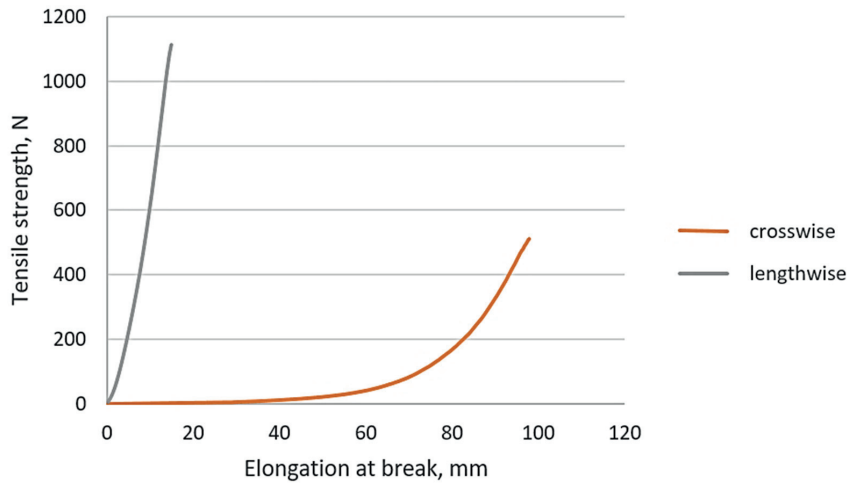


Figure 1.8. Tensile strength of Defender M Stretch

Fig.1.8. shows that the Defender M Stretch fabric elongates well crosswise, yet it has low tensile strength. Its breaking strength lengthwise is high, but, given the small elongation ability, the fabric is unsuitable for the crotch part, as at sharp movements the fabric would tear lengthwise.

Table 1.15. summarizes the results of tensile strength and elongation of fabrics that were not washed, as well as of those that were washed and dried at room temperature and washed and dried at 60°C. The tensile strength of the PUMA 220 fabric lengthwise changes within the range of 4%, while the relative elongation increases by 10%, which can be explained by the fact that the fabric shrinks and wefts and warps densify in washing. Elongation of the PUMA 240 fabric increases crosswise.

Table 1.15.



**Summary of tensile strength and elongation results**

			<b>PUMA 220</b>	<b>PUMA 240</b>	<b>Schoeller No 81029</b>	<b>Defender M Stretch</b>
	Tensile strength, N	lengthwise	1020	1000	980	1110
		crosswise	720	560	1040	510
	Relative elongation, %	lengthwise	37	24	139	8
		crosswise	19	18	128	98
Washed and dried 5 times at room temperature	Tensile strength, N	lengthwise	980	1030	930	-
		crosswise	680	570	1150	-
	Relative elongation, %	lengthwise	47	22	130	-
		crosswise	22	24	140	-
Washed and dried 5 times at 60°C	Tensile strength, N	lengthwise	1000	1000	930	-
		crosswise	690	520	1080	-
	Relative elongation, %	lengthwise	47	23	146	-
		crosswise	24	23	141	-

Since the PUMA 240 has very low mechanical qualities, fabrics from different supplies were tested, but the results are very similar.

In the specification, the abrasion resistance of the PUMA 220 fabric is given as  $\geq 250,000$  cycles, which it withstands, while for the PUMA 240 fabric it is given as  $\geq 300,000$  cycles, however its true abrasion resistance is around 75,000 cycles (Table 1.16.), which makes this fabric unsuitable for sewing trousers of field uniforms for the NAF.

Table 1.16.

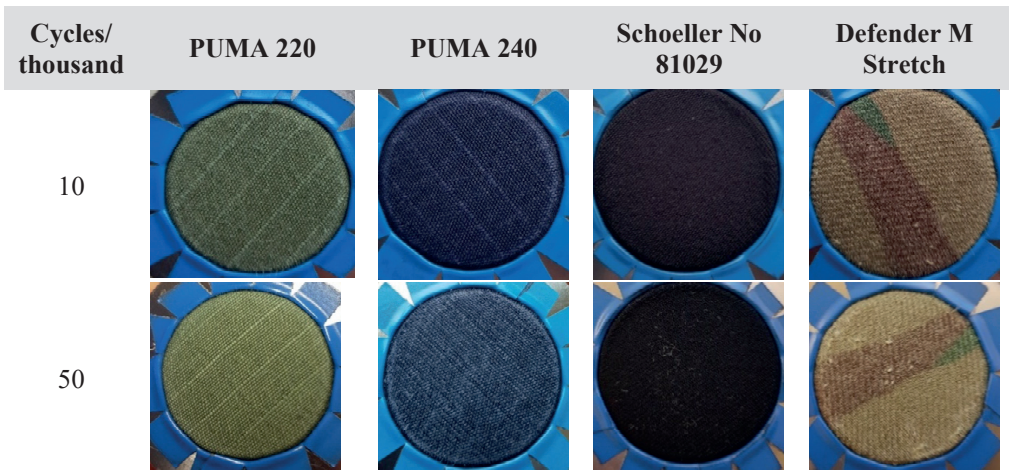
**Results of abrasion resistance**

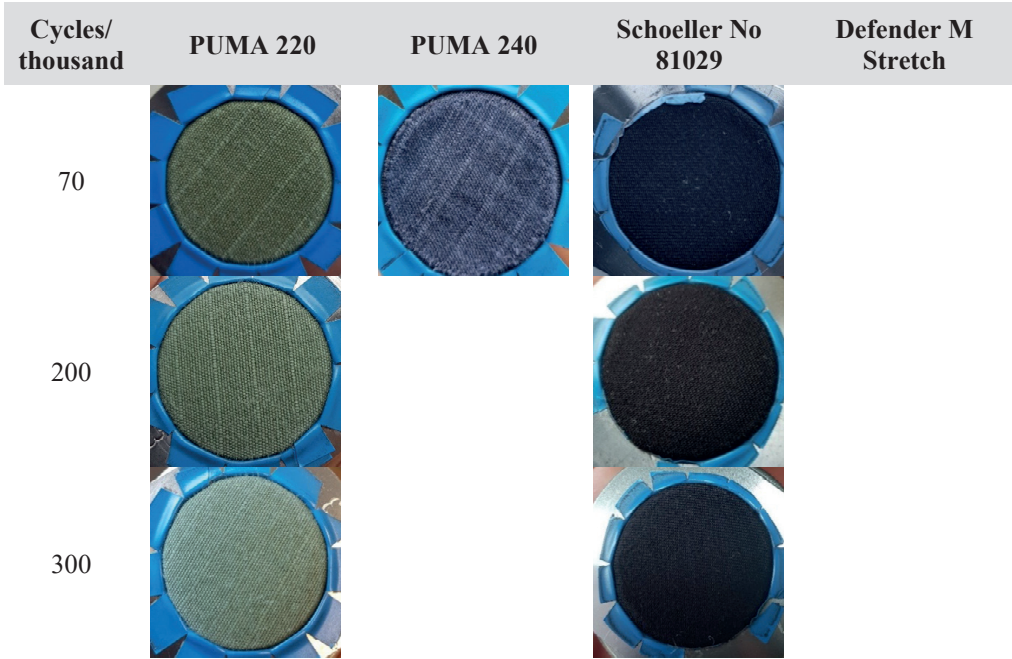
<b>Fabric</b>	<b>Nominal pressure</b>	<b>Testing intervals, in which breaking occurred, cycles</b>			<b>Mean resistance to rubbing, cycles</b>
PUMA 220	12kPa	≥ 300 000	≥ 300 000	≥ 300 000	≥ 300 000
PUMA 240	12kPa	70 000	80 000	80 000	75 000
Schoeller Nr.81029	12kPa	≥ 300 000	≥ 300 000	≥ 300 000	≥ 300 000
Defender M Stretch	12kPa	60 000	50 000	50 000	50 000

The degree of colour fastness is also very important factor in testing abrasion resistance, given that the fabric will be printed. The appearance of the Schoeller No. 81029 fabric remains unchanged during all 300 000 cycles. For the Defender M Stretch, colour changes appear after 5 000 cycles and the fabric looks faded. Changes in the PUMA 220 appear after 10 000 cycles, while for the PUMA 220, changes in colour are visible only when comparing a specimen with a new piece of fabric.

Table 1.17.

**Changes of fabric appearance during abrasion resistance testing**





The results of the colour fastness test (Table 1.18.) confirm the visible removal of the colour from the fabrics during the abrasion test. The results obtained during dry abrasion for all fabrics are within permissible limits, while the results obtained during wet abrasion of the PUMA 240 and Defender M Stretch are too low for those fabrics to be used for printing, and they do not correspond the values given by the manufacturer (see Table 1.11.), according to which, the values should be  $\geq 4$ . The colour fastness is especially important for field uniforms as they are printed with a camouflage pattern and, if it has faded or damaged, the uniform is no longer usable.

Table 1.18.

Results of colour fastness test

	PUMA 220	PUMA 240	Schoeller No 81029	Defender M Stretch
Dry abrasion	5	4	5	4
Wet abrasion	5	2-3	5	2-3

Field uniform trousers are used at high physical load, therefore the air permeability is very important for a good fabric. The uniform is used both in summer and winter, but the air permeability of garments must be appropriate for use in summer, as in the cold weather there are 3 levels of underwear that provide heat.

The air permeability (Table 1.19.) of all tested materials is adequate to provide comfort during various physical activities.

Table 1.19.

**Results of the air permeability**

Type of fabric	Pressure difference, Pa	Mean arithmetic air permeability, l/min	Coefficient of variation, %	Coefficient of air permeability, mm/s
PUMA 220	100	2,1	6	71
PUMA 240		3,3	7	109
Schoeller No 81029		3,2	9	107
Defender M Stretch		8,1	9	270

After performing the test of water vapour resistance, it has been found that all fabrics are designed to provide comfort during high physical loads (Table 1.20.). According to the coefficient of variation, it can be concluded that fabrics of the same type and content may differ by supplies.

Table 1.20.

**Results of water vapour resistance measurements**

	Water vapour resistance, m <sup>2</sup> *Pa/W	Coefficient of variation, %	Water vapour resistance after 5th washing cycle, m <sup>2</sup> *Pa/W	Coefficient of variation, %
PUMA 220 (1st supply)	5.2	12	5.9	10
	5.0		5.5	
PUMA 220 (2nd supply)	4.1	10	4.8	1
	3.0		4.0	
PUMA 240 (1st supply)	3.3	2	4.0	0
	2.7		3.9	
Schoeller No. 81029	4.5	2	5.6	0
	4.6		5.6	

Fabric test results are summarized in Table 1.21.

Table 1.21.

## Summary of fabric test results

		<b>PUMA 220</b>	<b>PUMA 240</b>	<b>Schoeller No 81029</b>	<b>Defender M Stretch</b>
Fibre content		50% CO, 50% PA	50% CO, 50% PA	90% PA, 10% EL	65% VI, 25% PPTA, 10% PA
Thickness, mm		0.40	0.44	0.73	0.49
Surface density, g/m <sup>2</sup>		213	219	255	207
Tensile strength, N	lengthwise	1020	1000	980	1110
	crosswise	720	560	1040	510
Relative elongation, %	lengthwise	37	24	139	8
	crosswise	19	18	128	98
Dimensional changes after 1 washing cycle 60°C, %	lengthwise	-4.0	-2.0	-3.5	-2.0
	crosswise	-2.0	-0.5	-1.0	-3.5
Dimensional changes after 5 washing cycles 60°C, %	lengthwise	-5.0	-3.5	-3.5	-3.0
	crosswise	-2.0	-0.5	0	-3.0
Abrasion resistance, cycles		≥300 000	75 000	≥300 000	50 000
Air permeability, mm/s		71	109	107	270
Colour fastness	dry abrasion	5	4	5	4
	wet abrasion	5	2-3	5	2-3

### 1.5. Sewing thread analysis

At present, a reinforced 100% polyester no.80 Kalyon sewing thread is being used for joints of the field uniforms, namely, for sewing, stitching, fastening and buttonholes, and a 100% polyester number 120 STA reinforced thread for overseaming, while SabaTEX 100% polyester of 120 multifilament thread was used previously.

Two more 100% polyester threads are offered for sewing field uniforms – reinforced Coats Epic no.100 and Saba<sup>c</sup> reinforced 100% polyester sewing thread no.120. Taking into

account that an elastic fabric will be connected to the basic fabric in the crotch area, the Coats Eloflex no.120 was also tested, due to its high elongation ability, the Coats seamsoft is considered as a possible thread for overseaming.

Table 1.22. shows a summary of available information about the selected thread obtained from the manufacturer's websites and the specifications therein.

In order to assess the sewing threads, their tensile strength and elongation were tested for all previously selected threads. This was done in line with the standard EN ISO 2062 "Textiles - Yarns from packages - Determination of single-end breaking force and elongation at break using constant rate of extension (CRE) tester" [51]. The obtained results are compared with requirements of the standard EN 12590 "Textiles. Industrial sewing threads made wholly or partly from synthetic fibres" [52] set for sewing threads of corresponding structure.

Table 1.22.

## Characteristics of sewing threads

Name	Coats Epic	Saba <sup>c</sup>	Kaloyñ	sabaTEX	STA	Coats nylbond	Coats Seamsoft	Coats eloflex
Fibre content	100% PES	100% PES	100% PES	100% PES	100% PES	100% PA	100% PES	100% PBT
Type of sewing thread	Reinforced	Reinforced	Reinforced	Multifilament	Reinforced	-	Micromultifilament	Textured multifilament
Application	Uniforms, workwear, jeans, jackets	Sports and outdoor clothes, workwear	Jackets, trousers	Sports and outdoor clothes, workwear	Jackets, trousers	Leather products, sports equipment	Sports clothes	Sports clothes
Linear density, tex	30	24	40	18	30	35	16	27
Thread number	100	120	80	120	120	80	120	120
Tensile strength, N	14,9	-	-	-	10	21,6	6,9	9,0
Elongation, %	17-22	-	16-20	-	16	15-26	22-34	50-70

Table 1.23. summarizes the information and test results about threads currently used for sewing trousers of field uniforms and threads tested to determine whether currently used sewing threads are the best solutions.

Table 1.23.

Summary of sewing thread characteristics and test results

	Kalyon	Coats Epic	Saba <sup>c</sup>	SabaTex	STA	Coats Eloflex	Coats Seamsoft
Thread number	80	100	120	120	120	120	160
Linear density, tex	40	30	24	18	30	27	18
Tensile strength, N	19.11	15.78	10.37	6.14	10.1	8.72	6.70
Coefficient of variation, %	8.6	3.1	2.5	5.9	3.6	1.1	3.5
Tensile strength in line with the standard EN 12590 [52]	17.0	12.5	9.8	12.5	9.8	-	-
Elongation at break, %	21	22.4	15.5	23.9	20.0	53.9	30.22
Coefficient of variation, %	6.1	2.3	1.6	8.1	3.5	2.1	9.0

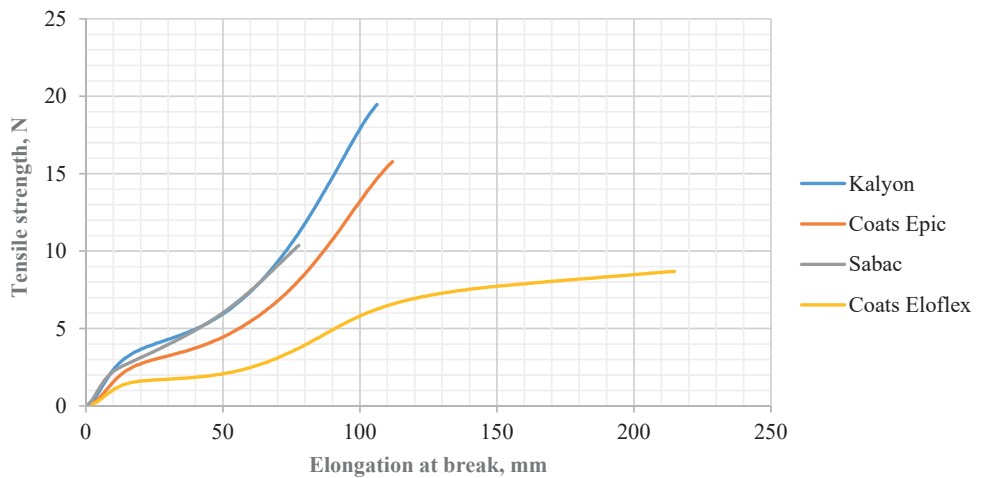


Figure 1.9. Tensile strength of sewing threads



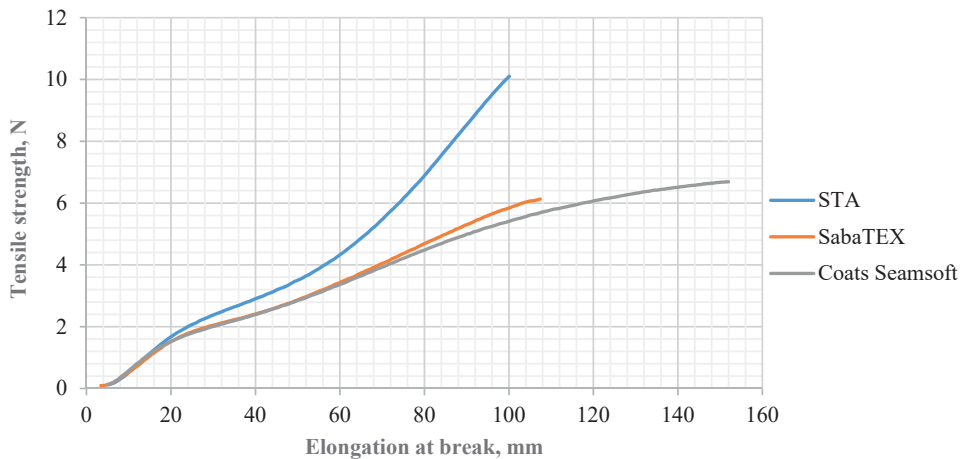


Figure 1.10. Tensile strength of overseaming threads

The results of the experiment show that the most durable thread is the Kalyon no.80 (Fig.1.9.), which is currently used for field uniforms, and from threads that are offered for overseaming (Fig.1.10.), the currently used STA sewing thread is the best solution. It can be concluded that the SabaTEX thread which was previously used for sewing field uniforms does not meet the standard requirement to withstand tensile strength of 12.5 N. The Coats eloflex thread is also selected for seam experiments due to its high extension.

### 1.6.Improvement of technological solutions

Not only appropriate materials are necessary for production of high quality and ergonomic uniforms, but also the right choice of technological solutions that can provide sufficient product quality during its wearlife under intense mechanical and physical impacts.

The purpose of the tests is to find out what seams are most optimal in the joints taking into account weather the seam is parallel or perpendicular to the lengthwise direction of the fabric and what the optimal sewing parameters are.

Two types of seams (Table 1.24.) were selected for the tests, in both variants, at first, the materials were sewn together with class 301 seams, then free edges were overseamed and simultaneously sewn together again with class 504 seam. In both variants, a lapped seam was sewn 2mm from the joint, in the 2nd variant – 5mm from the previous seam or 7 mm from the joint, one more seam is sewn. Seam allowance in both versions is 10 mm.

Table 1.14.

## Types of seams

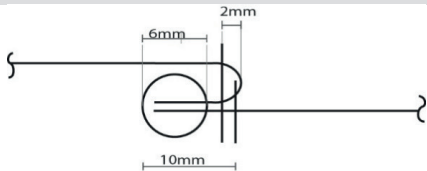
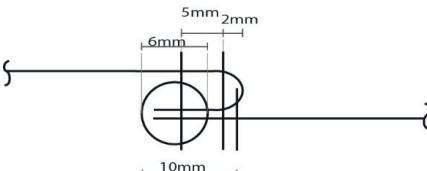
Item	Scheme of seam	Stitches/cm	Seam class
1		4	301+ 504
2		4	301+ 504

Fig.1.11. shows the seam strength using different types of seam and threads to connect the PUMA 220 fabric crosswise that imitates one of the problem zones in the trousers – a crotch. At present, the type 2 seams and the Coats Nylbound threads are used for joints (Table 1.24.). Test results lead to a conclusion that the use of Coats Nylbound threads is unnecessary because the results of the tensile strength test with the same kind of seam sewn with the Kalyon threads is within the percentage error.

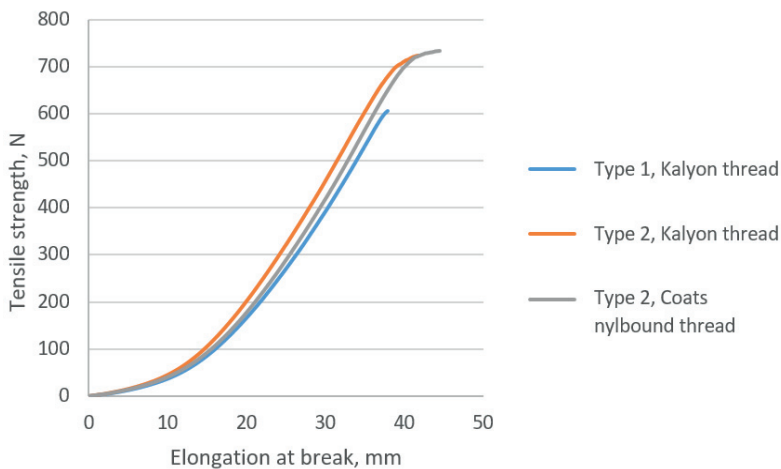


Figure 1.11. Seam strength for the PUMA 220 joining crosswise

Table 1.25. shows that in case of seam of type 1 the joint gets torn. The tensile strength of the seam of type 2 is higher than that of the PUMA 220 fabric crosswise, which is why the fabric is torn instead of the joining, regardless of threads that were used.

Table 1.25.

## Seam strength of PUMA 220 joining crosswise

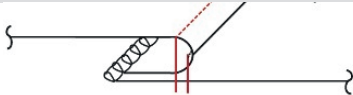
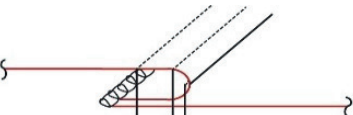
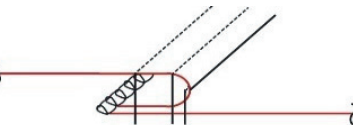
Scheme of seam	Type of seam	Fabrics	Sewing thread	Tensile strength, N	Elongation at break, mm	Elongation at break, %
	1	PUMA 220	Kalyon, STA	574	37	18
	2	PUMA 220	Kalyon, STA	724	42	21
	2	PUMA 220	Coats Nylbound, STA	734	45	23

Fig.1.12. shows the seam strength in joining the PUMA 220 fabric lengthwise, and Table 1.26. shows that the thread joints are broken in both types of seams. The mean tensile strength of the fabric lengthwise is 1020 N, the strength of the type 2 seam is approximately 900 N; therefore seams requiring high durability should be used for type 2 joining.

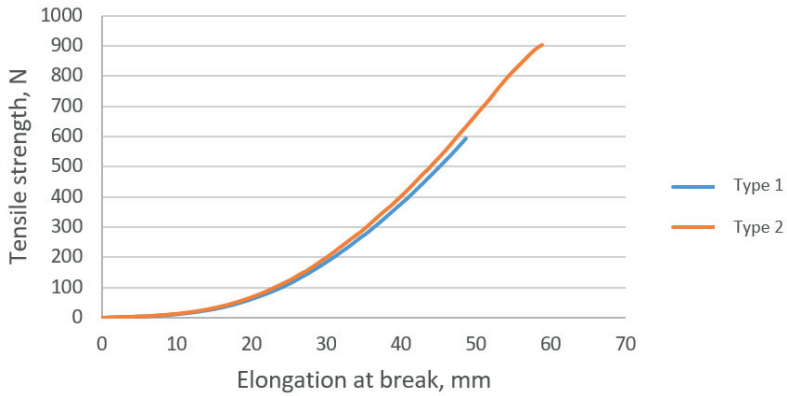
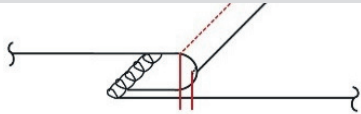
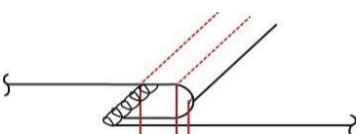


Figure 1.12. Seam strength for PUMA 220 joint lengthwise

Table 1.26.

Seam strength for PUMA 220 joining lengthwise

Scheme of seam	Type of seam	Fabrics	Sewing threads	Tensile strength, N	Elongation at break, mm	Elongation at break, %
	1	PUMA 240	Kalyon, STA	593	49	24
	2	PUMA 240	Kalyon, STA	904	59	29

In order to find out the most suitable threads for seaming and overseaming, seams of type 1 were sewn with Coats eloflex, Kalyon and Coats nylbound threads. Although the Coats eloflex thread shows high extension, the tensile strength of the joining is lower than in others, and the thread is relatively expensive. The joining with the Coats Nylbound thread shows the same results as the joining with the Kalyon thread, so it is not necessary to use it with regard to its cost, as well as the time taken to change the thread for the sewing machine and adjusting the voltage.

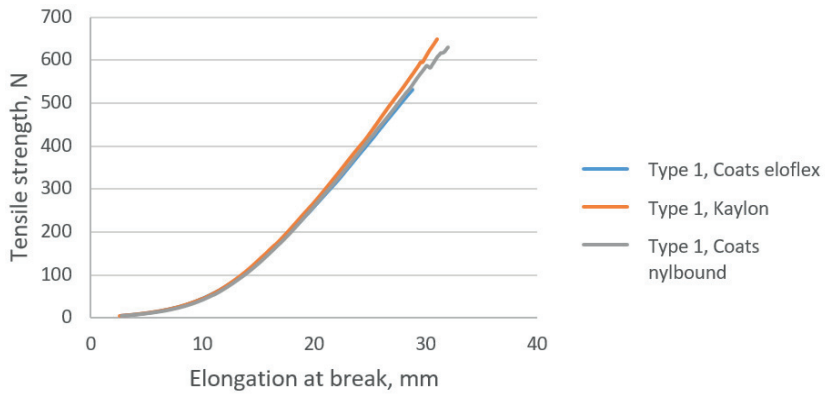


Figure 1.13. Seam strength of the PUMA 240 fabric lengthwise, using various threads

Table 1.27. shows that the tensile strength of the joining with Kalyon and Coats Nylbound threads is similar, however, in the case of the Kalyon thread, the joining breaks, while in case with the Coats Nylbound thread there are samples where the fabric also breaks.

Table 1.27.

Seam strength of the PUMA 240 fabric lengthwise, using various threads

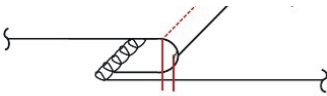
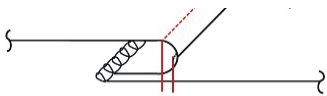
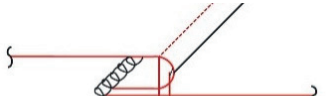
Scheme of seam	Type of seam	Fabrics	Sewing threads	Tensile strength, N	Elongation at break, mm	Elongation at break, %
1 	1	PUMA 240	Coats eloflex, STA	530	29	14
2 	1	PUMA 240	Kalyon, STA	660	31	16
3 	1	PUMA 240	Coats Nylbound, STA	620	32	16

Fig.1.14. shows PUMA 220 and PUMA 240 2 types of joining with Schoeller No. 81029. In both cases, the seam for the PUMA 220 fabric was torn, but for the PUMA 240 fabric, in case seam of type 2, one of the fabrics is torn.

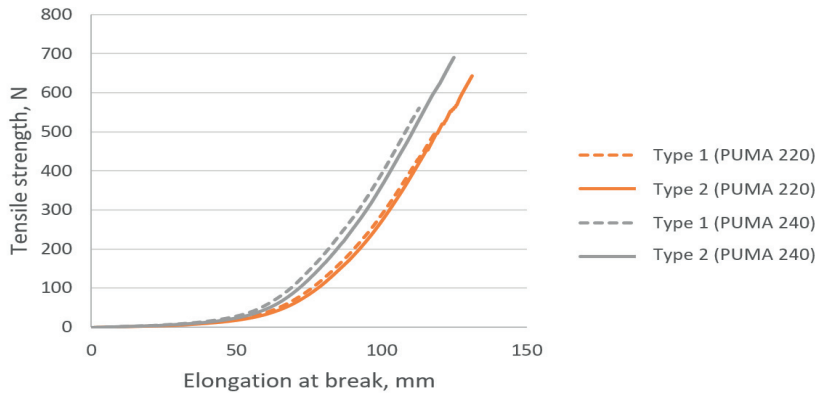


Figure 1.111. Seam strength in PUMA 220 and 240 joints with Schoeller No. 81029

Table 1.28.

Seam strength in the PUMA 220 and 240 joining with Schoeller No. 81029

Scheme of seam	Type of seam	Fabrics	Sewing threads	Tensile strength, N	Elongation at break, mm	Elongation at break, %
1	1	PUMA 220, Schoeller No. 81029	Kalyon, STA	506	119	60
2	2	PUMA 220, Schoeller No. 81029	Kalyon, STA	644	131	66
3	1	PUMA 240, Schoeller No. 81029	Kalyon, STA	560	113	56
4	2	PUMA 240, Schoeller No. 81029	Kalyon, STA	690	128	64

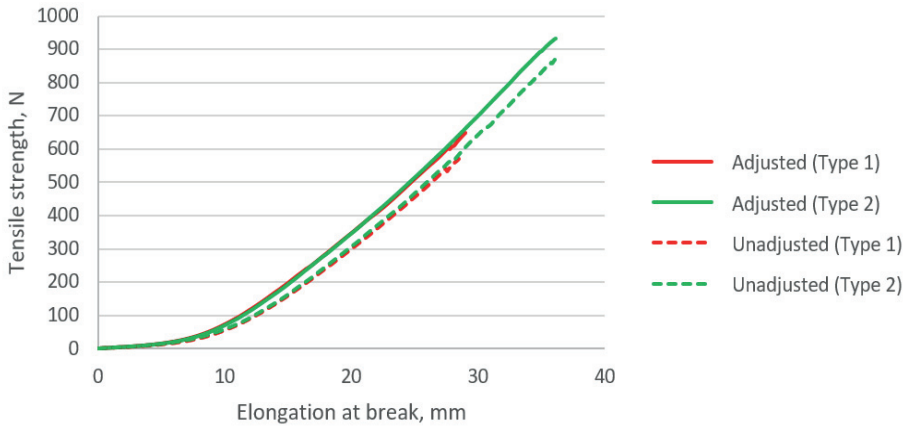


Figure 1.15. Tensile strength depending on thread tension

Table 1.29.

Tensile strength depending on thread tension

Scheme of seam	Type of seam	Fabrics	Sewing threads	Tensile strength, N	Elongation at break, mm	Elongation at break, %
	1	PUMA 240	Kalyon, STA	650	29.0	14.5
	2	PUMA 240	Kalyon, STA	930	36.1	18.0
	1	PUMA 240	Kalyon, STA	570	28.5	14.2
	2	PUMA 240	Kalyon, STA	870	36.0	18.0

Fig.1.15. and Table 1.29. show how tensile strength is affected by thread tension. For samples 1 and 2, the thread tension was adjusted as needed, while threads 3 and 4 were insufficiently tensioned. The experimentally obtained data lead to a conclusion that unadjusted thread tension reduces the seam strength.

Seams with 2 overseams and sewn parallel to the fabric lengthwise, are more durable than the material itself, thus making the material to tear before breaking of the seam, which is negative, considering the fact that torn thread joining is easier to repair rather than the fabric. Seams with 2 overseams sewn perpendicularly to the fabric lengthwise have very high tensile strength and are weaker than the fabric.

Currently, crotches of the field uniform trousers and fork joints are sewn using the type 2 seam or two overseams, and it is still advisable to use the same type of seam, but it is necessary to observe more strictly all necessary sewing parameters. Trousers crotches require sewing in a rhombic inlet to increase the ease of movement and durability of trousers with the use of the type 2 seams sewing overseams on the base material.

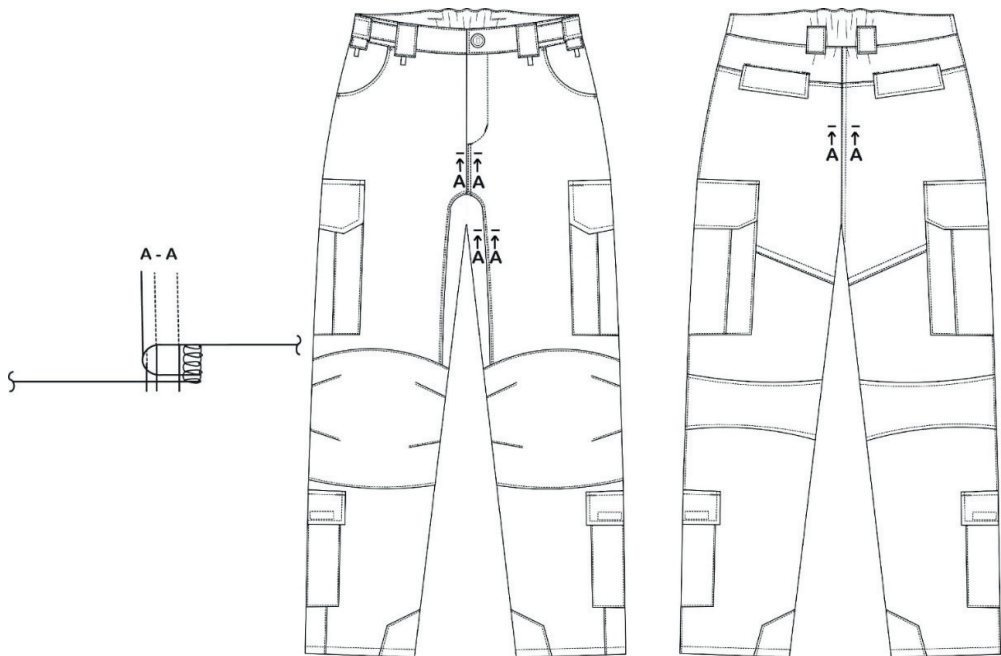


Figure 1.16. Technological drawing of trousers



Field uniform trousers are subject to harsh conditions of use as soldiers climb, crawl, run, and carry out other activities in course of performance of their duties. Under these circumstances, the strength of the fabric both lengthwise and crosswise, the design of joining and the size of trousers that suits the soldier's size thus ensuring the highest possible level of comfort and longer wearlife of the product is of great importance.

The results of the research tests show that:

- Of all the fabrics examined, the PUMA fabrics are the most suitable for sewing Level 4 field uniforms. Although it must be taken into account that the actual characteristics indicated for the PUMA 220 and PUMA 240 fabrics do not correspond to those given by manufacturers. The PUMA 220 fabric, after washing and drying in accordance with care instructions, shrinks by 5% lengthwise. While the PUMA 240 shows low tensile strength crosswise, its wear resistance is four times lower, as specified in the manufacturer's specification and low colour fastness. Consequently, manufacturer of field uniforms must thoroughly inspect conformity of the quality of fabrics to the technical parameters indicated by manufacturers of the fabrics;
- The auxiliary material Schoeller No 81029 is durable and elastic to be used as an inlet for the crotch area of the field uniform trousers, but when washed and dried in accordance to manufacturer's instructions, it shrinks by 3.5% lengthwise;
- The actual characteristics of the auxiliary material Defender M Stretch do not conform to the specifications given by the manufacturer, thus making the fabric unsuitable for sewing in the crotch of the field uniform trousers due to its low extension lengthwise, colour fastness, and abrasion resistance;
- Currently, threads used for sewing field uniform are considered to be the most suitable. The Kalyon reinforced 100% polyester thread is used for sewing, stitching, fastening and buttonholes, but the STA reinforced 100% polyester thread no 120 is used for overseaming. The tensile strength of both threads corresponds to the standard requirements;
- One of the biggest problems in regard to field uniform trousers is insufficient durability in the crotch area – both the thread joining and the material itself cannot withstand the load. At the moment, the crotch is joined with overseamed ironed lapped seam with two stitches and the Coats Nylbound sewing thread. After evaluating the results of the experiment, it was concluded that the use of special threads for this joining is not necessary, considering the fact that the Kalyon threads used in other kinds of joining can provide the same seam strength;

- It is also advisable to use the type 2 or overseamed ironed lapped seam with two stitches; however, all sewing parameters should be complied with more strictly. In order to relieve the crotch part of the trousers, a rhomb-shaped inlet – an inlay – is required to increase the ease of movement and the strength of trousers. The inlay should be sewn in using an overseamed ironed lapped seam with two stitches, sewing on the base material;

- In order to increase the strength of the joints, it is necessary to properly tighten the thread during the sewing of field uniform, to keep even number of stitches in a centimetre: 4 stitches/cm, to observe widths of seam allowances and to sew overseams according to the recommendation - 2 and 7 mm from the edge.

## 2. EXPERIMENTAL STUDY UNDERWEAR FABRICS

### 2.1. First level

Five level 1 underwear fabrics were selected for the experiment. Among them there is the knitted fabric currently used for sewing level 1 undergarments and four other level 1 underwear fabrics offered by SRC Brasa Level 1 underwear fabrics must be:

- lightweight,
- fairly thin;
- with good antimicrobial properties;
- with good air permeability;
- with low water vapour resistance, to easily remove sweat from the underclothing layer;
- elastic, with little unrecovered elongation;
- with little dimensional changes in care;
- with good colour fastness in washing, abrasive wear-and-tear and sweating;
- must withstand fairly high mechanical stresses at elongation.

The following testing methods were used in the experiment:

- EN ISO 5084 Textiles - Determination of thickness of textiles and textile products [50];
- EN 12127 Textile fabrics - Determination of mass per unit area using small samples [42];
- EN ISO 5077 Textiles. Determination of dimensional change in washing and drying [15];
- EN ISO 6330 Textiles. Domestic washing and drying procedures for textile testing [14];
- EN ISO 11092 Textiles. Physiological effects. Measurement of thermal and water-vapour resistance under steady-state conditions (sweating guarded-hotplate test) [16];
- EN ISO 12945-2 Textiles - Determination of fabric propensity to surface fuzzing and to pilling - Part 2: Modified Martindale method [33];
- EN ISO 13934-1 Textiles - Tensile properties of fabrics -- Part 1: Determination of maximum force and elongation at maximum force using the strip method [11];
- EN ISO 9237 Textiles - Determination of the permeability of fabrics to air [43];
- EN 14704-1 Determination of the elasticity of fabrics Part 1: Strip tests. Determination of the elasticity for woven fabrics using strip tests [53];

Prior to the experiments, all samples were conditioned under normal climatic conditions in accordance with the standard EN ISO 139:2005+A1 “Textiles - Standard atmospheres for conditioning and testing” [54]. Experimentally obtained results are summarized in Table 2.1.

Table 2.1.

## Experimental results of level 1 underwear fabrics 1

		Currently used	B-1	C-1	D-1	E-1
Fibre content		100 % PES	54% Coolmax®, 46% Coolmax Fresh®	88% PES, 12% Spandex	100 % PES	50% Coolmax®, 50% Coolmax Fresh®
Thickness, mm		0,29±0,01	0,38±0,01	0,41±0,01	0,39±0,01	0,38±0,01
1m <sup>2</sup> mass, g		126±6	146±7	237±12	140±7	122±6
Air permeability	Pressure difference, Pa	40	40	40	40	40
	Coefficient of air permeability mm/s	401±34	> 835	28±2	> 835	> 835
Breaking strength (N)	lengthwise	340±34	390±39	480±48	500±50	380±38
	crosswise	100±10	270±27	370±37	280±28	250±25
Breaking elongation (%)	lengthwise	91±9	117±12	335±34	110±11	132±13
	crosswise	163±16	142±14	415±42	178±18	164±16
Piling		5	5	4	5	5
Thermal resistance m <sup>2</sup> K/W		0,0024 ±0,0005	0,0021 ±0,0005	0,0047 ±0,0005	0,0005 ±0,0005	0,0014 ±0,0005
Water vapour resistance m <sup>2</sup> Pa/W		1,4±0,1	1,3±0,1	2,8±0,2	1,9±0,1	1,8±0,1
Elasticity	Load during each cycle, N	15	15	20	15	15
	Un-recovered elongation lengthwise %	0,0	0,0	4±1	1±1	1±1
	Elongation lengthwise %	22±2	28±3	119±12	21±2	39±4
	Un-recovered elongation lengthwise %	3±1	0,0	7±1	2±1	2±1
	Elongation crosswise %	96±10	45±4	118±12	61±6	67±6
Dimensional changes after one washing cycle 40°C (%)	lengthwise	-3±0,5	-2,5±0,5	-2±0,5	-1±0,5	-1,5±0,5
	crosswise	-1,5±0,5	-1,5±0,5	0	-1±0,5	-2,0±0,5
Dimensional changes after five washing cycles 40°C (%)	lengthwise	-5±0,5	-4,5±0,5	-2±0,5	-4±0,5	-2,5±0,5
	crosswise	-3,0±0,5	-2,5±0,5	-1±0,5	-2±0,5	-4±0,5
Observations			electrisation			

As can be seen from the data obtained, the currently used knitted fabric is the thinnest, with relatively low mass of  $1\text{m}^2$ . At the same time, due to the relatively high density of the knitting, it has relatively low air permeability. The air permeability has been tested at pressure difference of 40 Pa which does not comply with 100 Pa recommended by the standard EN ISO 9237 [43], as the knitted fabrics, due to the loop structures, have relatively high air permeability and it is difficult to create pressure differences to all of the fabrics and the results of air permeability measurements exceed the measurement range of the device being tested. The same pressure difference on both sides of the fabric was selected for all of the fabrics so that it is possible to compare them. At a pressure difference of 40 Pa, significant differences in air permeability were observed. At the same time, the currently used level 1 undergarment fabric showed low water vapour resistance and moderate thermal resistance compared to other experimentally tested fabrics. After testing mechanical properties of the fabrics, it can be said that the main disadvantage of the fabric currently used by NAF for level 1 underwear could be its relatively low elongation strength and 3% unrecovered elongation. Most likely this is the most important reason for the poor stability of undergarment sizes during wear.

The currently used level 1 undergarment fabric shows very high dimensional changes after washing. The washing was carried out at  $40^\circ\text{C}$  and the samples were dried in a dryer at  $60^\circ\text{C}$ . It is likely that the high dimensional changes are due to the high temperature in the dryer.

Of the five level 1 fabrics, the fabrics B-1, D-1 and E-1 were found as the most suitable. These fabrics show very good air permeability. The fabric B-1 has the lowest water vapour resistance, while fabrics D-1 and E-1 showed low thermal resistance. They have relatively high breaking strength. As to elasticity, it should be noted that fabrics do not show very high elongation properties at low loads, while showing low unrecovered elongation. The fabric B-1 showed unrecovered elongation of 0%, meaning that its dimensions will not change due to elongation. Despite this, the size and shape of the product may change during care. The fabric B-1 was not tested, however its pronounced electrification was observed during the experiments, which was not observed in other fabrics.

For the fabrics B-1 and E-1, air permeability changes as well as changes in elongation and unrecovered elongations during washing cycles were additionally tested. Unfortunately, it was not possible to test these parameters for the fabric D-1 due to insufficient quantity of the fabric. The data obtained during the experiments are summarized in Tables 2.2. and 2.3.

Table 2.2.

**Air permeability coefficient (mm/s)**

Fabrics	Air pressure difference	Washing times			
		Unwashed	1 <sup>st</sup> washing	3 <sup>rd</sup> washing	5 <sup>th</sup> washing
<b>B-1</b>	40 Pa	>835	>835	>835	>835
<b>E-1</b>	40 Pa	>835	>835	815±34	635±34

Table 2.3.  
**Unrecovered deformation and elongation (%) of knit fabrics depending on washing**

			<b>B-1</b>	<b>E-1</b>
<b>Unwashed</b>	lengthwise	Elongation %	28±3	39±4
		Unrecovered deformation %	0	1±1
	crosswise	Elongation %	45±5	67±6
		Unrecovered deformation %	0	2±1
<b>After 1<sup>st</sup> washing cycle</b>	lengthwise	Elongation %	30±3	46±5
		Unrecovered deformation %	0	0
	crosswise	Elongation %	50±5	76±7
		Unrecovered deformation %	1±1	1±1
<b>After 3<sup>rd</sup> washing cycle</b>	lengthwise	Elongation %	36±3	52±5
		Unrecovered deformation %	0	1±1
	crosswise	Elongation %	58±6	93±9
		Unrecovered deformation %	1±1	4±1
<b>After 5<sup>th</sup> washing cycle</b>	lengthwise	Elongation %	35±3	62±6
		Unrecovered deformation %	1±1	1±1
	crosswise	Elongation %	62±6	101±10
		Unrecovered deformation %	2±1	4±1

The fabric B-1 after five washing cycles has retained consistently high air permeability. For the fabric E-1, after five washing cycles the air permeability has decreased, despite the fact that its linear dimensions have changed less than in the fabric B-1. The fabric E-1 after washing tends to deform more and its unrecovered deformation tends to increase faster.

Consequently, the fabric B-1 can be considered as the most suitable of all of the level 1 underwear fabrics.

## 2.2. Second level

Five level 2 underwear fabrics were selected for the experiment. Among them there is the knitted fabric currently used for sewing the level 2 undergarments and four other level 2 underwear fabrics offered by SRC Brasa. Level 2 undergarment fabrics are subjected to requirements similar to those of level 1 fabrics. It must be:

- lightweight,
- with good antimicrobial properties;
- with low water vapour resistance, to easily remove sweat from the underclothing layer;
- elastic, with little unrecovered deformation;
- with little dimensional changes during care;
- good colour fastness in washing, abrasive wear-and-wear and sweating;
- must withstand fairly high mechanical stresses during tension.

Requirements that are different from those set out for level 1 undergarment fabrics are as follows – level 2 underwear fabrics should provide better thermal protection properties and should have good though not overly high air permeability.

For testing level 2 undergarment fabrics, the same testing method was used as for testing level 1 undergarment fabrics. The samples were conditioned under normal climatic conditions in accordance with the requirements of standard EN ISO 139:2005+A1 “Textiles – Standard atmospheres for conditioning and testing” [54].

Experimental results of testing level 2 undergarment fabrics are summarized in Table 2.4. Currently, underwear fabric used by NAF for the level 2 underwear is designated as F-2.

Table 2.4.

### Level 2 underwear fabric testing results

		F-2	G-2	H-2	I-2	J-2
Fibre content		97% PES, 3% yarns with silver coating	83% PES, 17% wool	77% PES, 23% wool	52% Thermolite®, 42% PES micro, 6% lycra	99% Coolmax Fresh®, 1% lycra
Thickness, mm		0,34±0,01	0,50±0,01	0,64±0,01	0,52±0,01	0,55±0,01
Mass of 1m <sup>2</sup> , g		133±7	212±11	268±13	227±11	223±11
Air permeability	Air pressure difference, Pa	50	50	50	50	50
	Coefficient of air permeability, mm/s	>835	>835	621±34	735±34	494±34
Breaking strength (N)	lengthwise	390±39	440±44	520±52	490±49	550±55
	crosswise	210±21	210±21	190±19	320±32	260±26
Breaking elongation (%)	lengthwise	100±10	70±7	86±9	170±17	187±19
	crosswise	225±22	208±21	258±26	241±24	362±36
Pilling		3	4	4	4	5
Thermal resistance, m <sup>2</sup> K/W		0,018±0,001	0,026±0,002	0,026±0,002	0,019±0,001	0,009±0,001
Water vapour resistance, m <sup>2</sup> Pa/W		2,3±0,2	3,5±0,2	3,3±0,2	3,6±0,2	2,6±0,2
Elasticity	Load during each cycle, N	15	15	15	20	15
	Un-recovered elongation lengthwise, %	1±1	0,00	0,00	1±1	2±1
	Elongation lengthwise, %	30±3	19±2	20±2	59±6	49±5
	Un-recovered elongation crosswise, %	7±1	4±1	4±1	6±1	9±1
	Elongation crosswise, %	108±11	<b>73±7</b>	76±8	109±11	133±13
Dimensional changes after one washing cycle, 40°C (%)	lengthwise	-4,5±0,5	-3±0,5	-3,5±0,5	-3,5±0,5	0
	crosswise	-2,5±0,5	-3±0,5	-2±0,5	1±0,5	-2±0,5
Dimensional changes after five washing cycles, 40°C (%)	lengthwise	-6±0,5	-5±0,5	-5,5±0,5	-5,5±0,5	-1±0,5
	crosswise	-6±0,5	-6±0,5	-3±0,5	0,5±0,5	-5±0,5
Observations				electrisation	electrisation	

Undergarment fabric currently used for level 2 underwear is knitted of polyester yarn containing 3% of silver. The presence of silver could give the underwear better antibacterial



properties during prolonged wearing when the soldier is unable to wash his or her undergarments due to the specific tasks of the service. The fabric F-2 is also the thinnest and lightest of all the fabrics. The fabric F-2 shows high air permeability and low thermal resistance. Unfortunately, the fabric F-2 shows high dimensional changes during washing and high unrecovered elongation in response to tension, which confirms the visually observed high loss of undergarment shapes during use. This fabric also has the highest piling, which additionally damages the product's visual appearance. Consequently, this fabric should be replaced by another, better fabric. The fabric I-2 additionally shows electrification.

The fabric H-2, due to wool yarns in the fabric, shows good thermal properties, but it is the heaviest one, has relatively high unrecovered deformation in response to tension, dimensional changes in washing and electrification. Regardless of the presence of elastic fibres, the fabrics I-2 and J-2 have high unrecovered deformation in response to tension and low thermal resistance. The fabric I-2 changes strongly its linear dimensions lengthwise, while the fabric J-2 – crosswise.

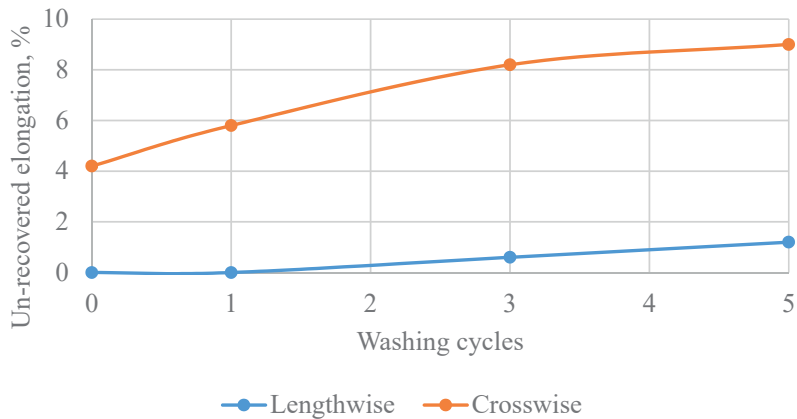
Table 2.5.

**Changes of properties of the fabric G-2 in washing**

<b>Characteristic</b>	<b>Unwashed fabric</b>	<b>After five washing cycles</b>
Air permeability at pressure difference 50Pa, mm/s	>835	574±34
Breaking strength, N:		
• lengthwise	440±44	410±41
• crosswise	210±21	206±21
Breaking elongation, %		
• lengthwise	70±7	88±9
• crosswise	208±21	268±27
Elongation at 15N, %		
• lengthwise	19±2	25±3
• crosswise	73±7	100±10
Unrecovered elongation, %		
• lengthwise	0,00	1,2±1
• crosswise	4±1	9±1

Looking at the initial results, the fabric G-2 could be recognized as the most suitable for level 2 undergarments, as most of the tested parameters are the most favourable ones. As this fabric is potentially best suited for level 2 undergarments, further testing was performed on it for determination changes in its properties after five washing cycles. The results obtained are

summarized in Table 2.5. It must be noted that when the fabric shrinks, its density increases significantly, resulting in reduction of air permeability almost by half after five washing cycles. The breaking strength of the fabric after five washing cycles slightly decreased lengthwise, but practically remained unchanged crosswise. At the same time, the elongation ability increased crosswise by 29%, while lengthwise – by 26%.



*Figure 2.1. Unrecovered elongation of the fabric G-2 in washing*

At the time of washing, the unrecovered elongation crosswise increased significantly, reaching 9% (see Fig.2.1.). The results indicate on substantial wear-and-tear of the fabric after first washing cycles. Consequently, this fabric could not be considered optimal for level 2 underwear, and it would be advisable to continue the search for more appropriate fabric.

### **2.3.Third level**

Four level 3 underwear fabrics were selected for the experiment. Among them there is the knitted fabric K-3 currently used for sewing level 3 undergarments and three other level 3 underwear fabrics used by SRC Brasa. Level 3 underwear fabric must have good thermal protection properties, it must provide a comfortable feel for the person in cool and cold weather conditions. Consequently, it is important that it has good thermal resistance and water vapour permeability. Similar to level 1 and level 2 underwear, it should be lightweight, with good antimicrobial properties, elastic, with little unrecovered elongation; it must not significantly change its linear dimensions during care, it must show good colour fastness in the result of

washing, abrasive wear-and-tear and under the influence of sweat, it must withstand fairly high mechanical stresses during tension.

For testing level 3 underwear fabrics, the same test method was used as for testing level 1 and level 2 undergarment fabric. The samples are conditioned in normal climatic conditions in accordance with the requirements of standard EN ISO 139:2005+A1 “Textiles – Standard atmospheres for conditioning and testing” [54].

The experimental results of level 3 underwear fabric tests are summarized in Table 2.6.

Table 2.6.

**Experimentally obtained results on level 3 fabrics**

		<b>K-3</b>	<b>L-3</b>	<b>M-3</b>	<b>N-3</b>
Fibre content		93% PES, 7% spandex	95% PES, 5% spandex	48% Cordura®, 38% PES 14% spandex	100% PES
Thickness (mm)		0,61±0,01	0,61±0,01	0,50±0,01	0,49±0,01
Surface density g/m <sup>2</sup>		230±12	294±15	249±	184±9
Air permeability	Pressure difference, Pa	50	50	50	50
	Coefficient of air permeability mm/s	728±34	190±34	53±34	661±34
Breaking strength (N)	lengthwise	270±27	390±39	530±53	300±30
	crosswise	200±20	290±29	310±31	150±15
Breaking elongation (%)	lengthwise	116±12	214±21	168±17	95±10
	crosswise	244±24	218±22	269±27	162±16
Piling		4	5	4	2
Thermal resistance m <sup>2</sup> K/W		0,04±0,01	0,05±0,01	0,02±0,01	0,48±0,01
Water vapour resistance m <sup>2</sup> Pa/W		5,2±0,4	6,1±0,4	3,1±0,2	4,1±0,3
Elasticity	Load during each cycle N	20	15	25	15
	Unrecovered elongation lengthwise %	2,0±1	6,0±1	2±1	1±1
	Elongation lengthwise %	49±5	74±7	38±4	32±3
	Unrecovered elongation crosswise %	9±1	3±1	6±1	4±1
	Elongation crosswise %	123±12	60±6	68±7	84±8
Dimensional changes after one washing cycle 40°C (%)	lengthwise	-2±0,5	-3±0,5	0,5±0,5	-3±0,5
	crosswise	-1±0,5	-1,5±0,5	-5±0,5	-0,5±0,5
Dimensional changes after five washing cycles 40°C (%)	lengthwise	-3±0,5	-3±0,5	0	-3±0,5
	crosswise	-2±0,5	-1±0,5	-6±0,5	-0,5±0,5

The currently used level 3 underwear fabric K-3 is one of the thickest undergarment fabrics. At the same time, it is not the heaviest one, which means that its structure is porous and potentially has good thermal protection, which is basically confirmed by the thermal resistance

value. The negative aspect of this fabric could be associated with high unrecovered elongation crosswise reaching up to 9%.

The fabric L-3 shows the same thickness, however it is much heavier. Since the fabrics L-3 and K-3 have very similar fibre composition, it can be said that the fabric L-3 has much higher volume fill than in case with the fabric K-3. Both fabrics have relatively high water vapour resistance. It is especially high for the fabric L-3 which practically makes it unsuitable for clothing to be worn in direct contact with the body.

Fabric N-3 shows the highest thermal resistance, however it is the thinnest one, with low breaking strength and breaking elongation, which raises concerns of its breakability during elevated physical activities. In addition, it should be noted that products made of these fabrics will quickly look worn out, as the fabric shows high piling.

For the fabric M-3, it is likely that Cordura, which is in its content, provides it with good mechanical properties, however it has low thermal resistance, very large dimensional changes crosswise in the result of washing, high unrecovered deformation crosswise and very low air permeability. In general, these drawbacks make the fabric M-3 inappropriate for level 3 undergarments.

Very much like in case with level 2 undergarments, the search for proper level 3 underwear fabric must be continued.

### 3. DEVELOPMENT OF A NEW PROTOTYPE OF WORK WEAR <sup>1</sup>

After the analysis of the dimension and size of the selected clothing and the summary of the surveys carried out for the evaluation of the currently produced workwear clothing model, the direction of changes was determined in order to improve the fitability and functionality of the garments expected by the recipients. The analysis of the results showed the need to personalize the work clothes based on individual silhouette measurements, which will allow to increase the fit of the outfits to the silhouettes and improve the comfort of use in working conditions.

The results of statistical analysis based on the collected measurement data were presented to project partner KRYSTIAN Company. Together, the needs of the respondents were determined in the area of fitting clothes to the figure and increasing satisfaction with the currently used work wear clothing.

Taking into account the postulated directions of structural and model changes as well as raw materials, the KRYSTIAN Company has made new prototypes of the workwear clothing model.

The clothing was subjected to the functional tests, during which the verification of the introduced design and raw materials solutions was carried out and the functionality of the clothing was assessed. After obtaining a positive user assessment, the new work clothing model was selected for activities aimed at equipping this clothing assortment with modern textronic solutions.

As part of the WP3 task, a preliminary analysis of information from scientific and specialist journals and the Internet about textronic solutions existing on the domestic and foreign market that could be implemented in workwear clothes was made. The presentation of approximately 30 examples of solutions was prepared and presented at the partners' meeting on 02.11.2016 at KRYSTIAN in Przysucha. Among the presented preliminary examples, the interest of the KRYSTIAN Management Board was aroused by RFID technology, therefore IW employees made a precise analysis of information on the types of sensors existing on the global market, their advantages and disadvantages, physical and mechanical properties, the size of possible data on particular types of sensors, the length of their range, the possibilities of their

---

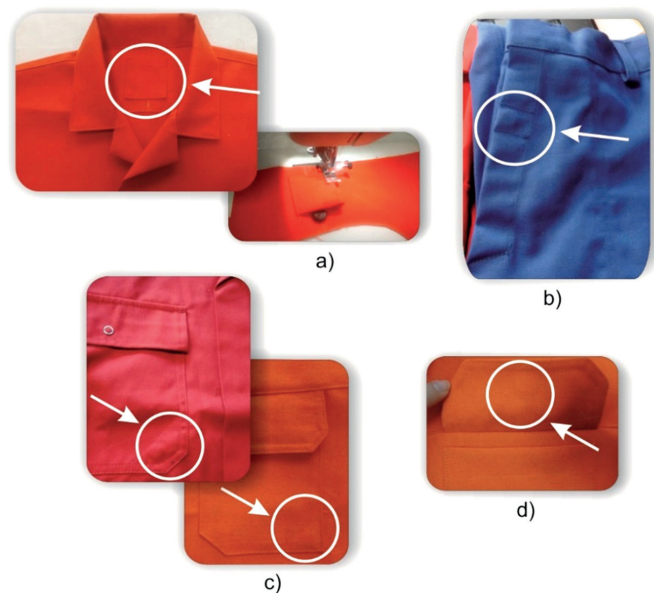
<sup>1</sup> According to Polish partner experience

application and implementation in the clothing product, the ways of their supply, their price, as well as information on manufacturers and distributors.

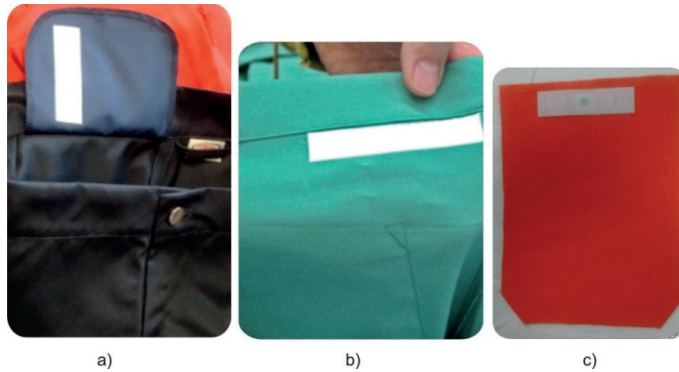
According to the analysis of needs, it was decided to choose Radio Frequency Identification RFID technology enabling automatic data identification (person identification, end user size, person identification with the article) and monitoring the time of clothing usage (date of clothing delivery to the end user, information on washing time and number of washing cycles after a certain number of hours).

In order to select the optimal way to implement the textronic devices in a clothing product, numerous technological tests were carried out to sew through the materials provided by the project partner, KRYSTIAN Company.

In clothing products intended for use in the work environment, the most commonly used tags are sewn-in or press-in, resistant to washing processes and accidental removal. The possible areas for tag installation in the clothing product and ways to assemble them are shown below.



*Figure 3.1. Exemplary localisation of sewn-in RFID tag: a) within the neck of the back of the sweatshirt, b) on the trouser slat, c) in the bottom corner of the applied pocket, d) between the layers of the pocket strap.*



*Figure 3.2. Exemplary localization of press-in RFID tag: a) on an element sewn into the belt of trousers, b) within the back of the trousers, c) at the top edge of the applied pocket.*

Based on the analysis of technological trials, a functional and ergonomic model of work wear clothing equipped with modern technological solutions that increase the comfort and safety of use was created.

### **3.1. Workwear clothing prototype testing**

In order to verify the solutions adopted for the assumed constructional model of a new working clothes prototype equipped with RFID tags, the evaluation of materials and electronic components of the product was carried out on the basis of selected laboratory tests carried out at the Research Laboratory of Raw Materials and Textile Products of the Textile Research Institute.

The research aimed to determine with what intensity and after what time changes in fabrics affect the aesthetic appearance and the durability of materials and check the strength of clothing elements - RFID tags after multiple maintenance processes.

The studies also include the determination of indicators of biophysical properties affecting the utility value of clothing in terms of physiological comfort.

In the scope of research covering the usage properties of materials and elements of the outfit, the following indicators were determined:

- abrasion resistance according to **EN ISO 12947-2:2017-02**. Textiles - Determination of the resistance of flat products to abrasion using the Martindale method - Part 2: Determination of destruction of a working sample [12];

- tendency to pilling and peeling according to **EN ISO 12945-2:2002**. Textiles - Determination of the tendency of a flat product surface for pilling and pilling – Part 2: Modified Martindale method, Determination of Martindale's abrasion resistance of flat products - Part 2: Determination of destruction of the working sample [33];
- resistance to light in accordance with **EN ISO 105-B02:2014-11**. Textiles - Colour resistance tests - Part B02: Colour fastness to artificial light: Pen test in the light of a xenon arc lamp [37];
- seam strength according to **EN ISO 13935-2:2014-06**. Textiles - Strength properties of seams made on flat textile products and ready-made textile products - Part 2: Determination of the maximum breaking force of the seam using the grab method [28];
- resistance to washing according to **EN ISO 6330:2012**. Textiles - Household washing and drying methods used for testing flat textile products, (assessment of change in appearance after domestic washing and drying according to Research Procedure No. 54: 2012) [14].

The level of comfort related to the hygienic properties of the materials was assessed on the basis of indicators such as:

- resistance of water vapor according to **EN ISO 11092:2014-11**, Textiles - Physiological properties -- Measurement of thermal resistance and water vapor resistance in steady state conditions (method of a heat-insulating slab) [16];
- air permeability according to **EN 9237:1998**, Textiles - Determination of air permeability of textile products [43].

The research material consisted of four fabrics with the following characteristics:

- **TenCate Tecawork™ BG 1003** navy blue colour, Easy Care finish:
  - stitch 2/1 twill,
  - raw material composition: Cotton 65% + Polyester 35%,
  - surface mass 255 g/m<sup>2</sup>,
- **TenCate Tecawork™ BG 1003** yellow colour, Easy Care finish:
  - stitch 2/1 twill,
  - raw material composition: Cotton 65% + Polyester 35%,
  - surface mass 255 g/m<sup>2</sup>,
- **TenCate Tecawork™ KG 308** navy blue colour, Easy Care, Skin+, Hydro-Tec finish,
  - stitch 2/1 twill,
  - raw material composition: Cotton 35% + Polyester 65%,



- surface mass 245 g/m<sup>2</sup>.
- **TenCate Tecawork™ KG 308** yellow colour, Easy Care, Skin+, Hydro-Tec finish,
  - stitch 2/1 twill,
  - raw material composition: Cotton 35% + Polyester 65%,
  - surface mass 245 g/m<sup>2</sup>,

and electronic components so called RFID tags.



Fabrics and RFID tags were provided by KRYSTIAN Company - project partner.

### 3.2. Preparation of materials for testing and test results

Samples of individual layers of fabrics were prepared for the tests (fabrics were marked: Sample 1 – “KG 308 Fabric, navy blue colour”, Sample 2 – “KG 308 Fabric, yellow colour”, Sample 7 – “BG 1003 Fabric, navy blue colour”, Sample 8 – “BG 1003 Fabric, yellow colour”) and fabrics sewn along the warp threads and along the weft threads (fabrics were marked: Sample 3 – Bottom seam on the fabric “KG 308 Fabric, navy blue colour”, Sample 4 – Bottom seam on the fabric “KG 308 Fabric, yellow”, Sample 5 – Side seam on the fabric “KG 308 Fabric, navy blue”, Sample 6 – Side seam on the fabric “KG 308 Fabric, yellow”, Sample 9 – Bottom seam on the fabric “BG 1003 Fabric, navy blue”, Sample 10 – Bottom seam on the fabric “BG 1003 Fabric, yellow”, Sample 11 – Side seam on the fabric “BG 1003 Fabric, navy blue”, Sample 12 – Side seam on the fabric “BG 1003 Fabric, yellow”), using the stitches and seams according to **PN-83/P-84502** Clothing products. Machine stitches. Classification and designations as well as **PN-83/P-84501**. Confection. Stitches. Classification and markings. Types of seams and stitches used are shown in Table 3.1.

Table 3.1.

**Types of machine stitches and seams chosen for tests**

No.	Designation of seam and stitch	Section
1.	1-needle stitch seam and overlock stitch 1.01.01/401.504 <b>Side seam on the fabric</b>	
2.	3-needle stitch seam 1.01.01/301.301.301 <b>Bottom seam on the fabric</b>	

In order to assess the resistance of electronic components to the maintenance conditions, tests were carried out for which the process of combining fabrics with RFID tags was performed by sewing or sticking them (Fig.3.3. a and b), in accordance with the adopted design assumptions. The tests were marked: Sample 1 - "KG 308 Fabric, navy blue" with sewn RFID tags, Sample 2 - "KG 308 Fabric, navy blue" with ironed RFID tags, Sample 3 - "BG 1003 Fabric, navy blue" with sewn RFID tags, Sample 4 - "BG 1003 Fabric, navy blue" with ironed RFID tags.



*Figure 3.3. Fabric sample a) with ironed RFID tags, b) with sewn RFID tags.*

Table 3.2.

Tests of properties of TenCate Tecawork™ KG 308 fabric and TenCate Tecawork™ BG 1003 fabric

Samples designation	Raw material composition [%]	Surface mass $[g/m^2]$	Tendency to pilling and piling degree	Resistance to abrasion number of strokes, min. value	Colour fastness to artificial light degree	The average resistance of water vapor, $R_w$ $[m^2Pa/W]$	Air permeability $[mm/s]$	The average maximum force breaking the seam $[N]$		Assessment of appearance after home washing and drying, <i>degree</i> Change in the colour of the product, <i>grey scale</i>		
								Seam parallel to the warp threads	Seam parallel to the threads	After 5 times home washing and drying	After 50 times home washing and drying	
Sample 1 "KG 308 Fabric, navy blue colour"	65 PES / 35 CO	245	3	25 000	5-6	$2,75 \pm 0,18$	$77,8 \pm 1,6$	$370 \pm 30$	$370 \pm 20$			
Sample 3 Bottom seam on the fabric "KG 308 Fabric, navy blue"			-	-	-	-	$624$ (breaking the product in the seam)					
Sample 5 Side seam on the fabric "KG 308 Fabric, navy blue"			-	-	-	-	-					
Sample 1 "KG 308 Fabric, navy blue colour", with sewn in RFID tags RFID			-	-	-	-	-			lack of changes in surface appearance of product-general colour change 4-5	slight change in the surface appearance of the product – general colour change 4-5	
Sample 2 "KG 308 Fabric, navy blue", with sewn in RFID tags			-	-	-	-	-			lack of changes in surface appearance of product-general colour change 4-5	slight change in the surface appearance of the product – general colour change 4-5	
Sample 2 "KG 308 Fabric, yellow colour"			2-3	60 000	5-6	$2,66 \pm 0,02$	$100 \pm 2$					
Sample 4 Bottom seam on the fabric "KG 308 Fabric, yellow"			-	-	-	-	-	$250 \pm 10$	$260 \pm 20$			
Sample 6 Side seam on the fabric "KG 308 Fabric, yellow"			-	-	-	-	-	$624$ (breaking the product in the seam)	$660 \pm 50$			
Sample 7 BG 1003 Fabric, navy blue colour"			65 CO / 35 PES	255	1	30 000	6	$2,47 \pm 0,06$	$89,6 \pm 1,4$	$290 \pm 10$	$410 \pm 30$	
Sample 9 Bottom seam on the fabric "BG 1003 Fabric, navy blue"	-	-			-	-	-					

Samples designation	Raw material composition [%]	Surface mass	Tendency to pilling and piling degree	Resistance to abrasion number of strokes, min. value	Colour fastness to artificial light degree	The average resistance of water vapor, Ra, [m <sup>2</sup> Pa/W]	Air permeability [mm/s]	The average maximum force breaking the seam [N]		Assessment of appearance after home washing and drying, Change in the colour of the product, grey scale degree	
								Seam parallel to the warp threads	Seam parallel to the threads	After 5 times home washing and drying	After 50 times home washing and drying
Sample 11 Side seam on the fabric "BG 1003 Fabric, navy blue"					-			340 ± 10	650 ± 30		
Sample 3 "BG 1003 Fabric, navy blue colour", with sewn in RFID tags					-			-		slight change in the surface appearance of the product – colour change 4. Crease of samples - change in colour at creases 3	a clear change in the appearance of the surface – colour change 3. Strong crease of samples - change in colour at creases 2
Sample 4 "BG 1003 Fabric, navy blue colour", with ironed RFID tags					-			-		slight change in the surface appearance of the product – colour change 4. Crease of samples - change in colour at creases 3	a clear change in the appearance of the surface – colour change 3. Strong crease of samples - change in colour at creases 2
Sample 8 BG 1003 Fabric, yellow colour			1	25 000	5 (change of colour to a more red one)	2,45 ± 0,04	89,6± 1,6				
Sample 10 Bottom seam on the fabric "BG 1003 Fabric, yellow"					-			290 ± 10	290 ± 10		
Sample 12 Side seam on the fabric "BG 1003 Fabric, yellow"					-			360 ± 10	590 ± 20		
<b>Test method</b>			EN ISO 12945-2 [33]	EN ISO 12947-2 [12]	EN ISO 105-B02 [37]	EN ISO 11092 [16]	EN ISO 9237 [43]	EN ISO 13935-2 [28] Seam performed by customer		The samples were subjected to a washing process at a temperature of 60°C (reference detergent 3, washer type A) in accordance with Test Procedure No. 54: 2012 edition 2 of the day 24.01. 2012 five and fifty times, drying in a tumble dryer method (temp 60°C) – F method according to EN ISO 6330 [14]. Evaluation: ISO 105-A02 [24]	

Reports on indicator tests: resistance to abrasion, tendency to pilling and peeling, colour fastness to artificial light and water vapor resistance:

- **BM 3.5.9/2018/W/G/A**, Sample 1 – “**KG 308 Fabric, navy blue colour**”,
- **BM 3.5.10/2018/W/G/A**, Sample 2 – “**KG 308 Fabric, yellow colour**”,
- **BM 3.5.11/2018/W/G/A**, Sample 7 – “**BG 1003 Fabric, navy blue colour**”,
- **BM 3.5.12/2018/W/G/A**, Sample 8 – “**BG 1003 Fabric, yellow colour**”.

Reports on air permeability index tests:

- **BM 3.6.1/2018/W/G/A**, Sample 1 – “**KG 308 Fabric, navy blue colour**”,
- **BM 3.6.2/2018/W/G/A**, Sample 2 – “**KG 308 Fabric, yellow colour**”,
- **BM 3.6.3/2018/W/G/A**, Sample 7 – “**BG 1003 Fabric, navy blue colour**”,
- **BM 3.6.4/2018/W/G/A**, Sample 8 – “**BG 1003 Fabric, yellow colour**”.

Reports on the seam strength index:

- **BM 3.5.1/2018/WG/A**, Sample 3 - Bottom seam on the fabric “**KG 308 Fabric navy blue**”,
- **BM 3.5.2/2018/WG/A**, Sample 4 – Bottom seam on the fabric ”**KG 308 Fabric, yellow**”,
- **BM 3.5.3/2018/WG/A**, Sample 5 – Side seam on the fabric “**KG 308 Fabric, navy blue**”,
- **BM 3.5.4/2018/WG/A**, Sample 6 - Side seam on the fabric “**KG 308 Fabric, yellow**”,
- **BM 3.5.5/2018/WG/A**, Sample 9 - Bottom seam on the fabric “**BG 1003 Fabric, navy blue**”,
- **BM 3.5.6/2018/WG/A**, Sample 10 - Bottom seam on the fabric “**BG 1003 Fabric, yellow**”,
- **BM 3.5.7/2018/WG/A** Sample 11 - Side seam on the fabric “**BG 1003 Fabric, navy blue**”,
- **BM 3.5.8/2018/WG/A**, Sample 12 - Side seam on the fabric “**BG 1003 Fabric, yellow**”.

Reports on colour resistance tests for washing:

- **BM 3.4.1/2018/W/G** Sample 1 – “**KG 308 Fabric, navy blue**”, with sewn-in RFID tags – the results of the assessment after washing,
- **BM 3.4.1.1/2018/W/G** Sample 1 – “**KG 308 Fabric, navy blue colour**”, with sewn-in RFID tags – washing procedures 5x (times),
- **BM 3.4.1.2/2018/W/G** Sample 1 – “**KG 308 Fabric, navy blue colour**”, with sewn-in RFID tags – washing procedures 50x (times),
- **BM 3.4.2/2018/W/G** Sample 2 – “**KG 308 Fabric, navy blue colour**”, with ironed RFID tags – the results of the assessment after washing,
- **BM 3.4.2.1/2018/W/G** Sample 2 – “**KG 308 Fabric, navy blue colour**”, with ironed RFID tags – washing procedures 5x (times),
- **BM 3.4.2.2/2018/W/G** Pr. 2 – “**KG 308 Fabric, navy blue colour**”, with ironed RFID tags – washing procedures 50x (times),
- **BM 3.4.3/2018/W/G** Pr. 3 – “**BG 1003 Fabric, navy blue colour**”, with sewn-in RFID tags – the results of the assessment after washing,
- **BM 3.4.3.1/2018/W/G** Pr. 3 – “**BG 1003 Fabric, navy blue colour**”, with sewn-in RFID tags – washing procedures 5x (times),,
- **BM 3.4.3.2/2018/W/G** Pr. 3 – “**BG 1003 Fabric, navy blue colour**”, with sewn-in RFID tags – washing procedures 50x (times),
- **BM 3.4.4/2018/W/G** Pr. 4 – “**BG 1003 Fabric, navy blue colour**”, with ironed RFID tags – the results of the assessment after washing,

- **BM 3.4.4.1/2018/W/G Pr. 4** – “**BG 1003 Fabric, navy blue colour**”, with ironed RFID tags – washing procedures 5x (times),
- **BM 3.4.4.2/2018/W/G Pr. 4** – “**BG 1003 Fabric, navy blue colour**”, with ironed RFID tags – washing procedures 50x (times).

Evaluation of tested samples of materials with sewn and glued RFID tags after washing processes.

Table 3.3.

Number of washing/Comments	Operation of RFID after conservation process			
	tags sewn-in		tags glued	
	Sample 1 - KG 308 fabric	Sample 3 - BG 1003 fabric	Sample 2 - KG 308 fabric	Sample 4 - BG 1003 fabric
<b>0</b>	<i>1 attempt</i>	<i>1 attempt</i>	<i>1 attempt</i>	<i>1 attempt</i>
<b>rating</b>	<b>active tag</b>	<b>active tag</b>	<b>active tag</b>	<b>active tag</b>
<b>5</b>	<i>1 attempt</i>	<i>1 attempt</i>	<i>1 attempt</i>	<i>1 attempt</i>
	<i>2 attempt</i>	<i>2 attempt</i>	<i>2 attempt</i>	<i>2 attempt</i>
	<i>3 attempt</i>	<i>3 attempt</i>	<i>3 attempt</i>	<i>3 attempt</i>
		<i>4 attempt</i>	<i>4 attempt</i>	<i>4 attempt</i>
<b>rating</b>	<b>active tag</b>	<b>active tag</b>	<b>active tag</b>	<b>active tag</b>
<b>50</b>	<i>1 attempt</i>	<i>1 attempt</i>	<i>1 attempt</i>	<i>1 attempt</i>
	<i>2 attempt</i>	<i>2 attempt</i>	<i>2 attempt</i>	<i>2 attempt</i>
	<i>3 attempt</i>	<i>3 attempt</i>	<i>3 attempt</i>	<i>3 attempt</i>
	<i>4 attempt</i>	<i>4 attempt</i>	<i>4 attempt</i>	<i>4 attempt</i>
	<i>5 attempt</i>	<i>5 attempt</i>	<i>5 attempt</i>	<i>5 attempt</i>
	<i>6 attempt</i>			
<b>rating</b>	<b>active tag</b>	<b>active tag</b>	<b>active tag</b>	<b>active tag</b>

### 3.3. Evaluation of test results

The assessment of the obtained values of indicators for the examined materials is presented in descriptive form in the following points.

- Material resistance to abrasion according to standard EN ISO 12947-2:2017-02 [12];

The tested fabrics meet requirements of standard **P-84525:1998 Work wear clothing -- Work clothes**, in the range of resistance to abrasion, results obtained are at the level of over 20,000 strokes. BG 1003 fabric in navy blue colour showed a slightly higher abrasion resistance compared to KG 308 fabric in the same colour. With regard to fabrics dyed in yellow, the KG 308 fabric showed a significantly higher resistance to abrasion compared to the BG 1003 fabric.

The obtained values indicate good fabric properties in terms of durability, resistance to abrasion.

- Tendency to pilling and pilling according to standard EN ISO 12945-2:2002 [33];

Tests results of tendency to pilling and pilling showed differentiation of resistance to this phenomenon for fabrics KG 308 and BG 1003 in both colour versions. The KG 308 fabric is characterized by a moderate tendency to form pilling on its surface, which provides greater aesthetic comfort in the use of clothing made of it in a longer time. On the other hand, BG 1003 fabric is characterized by low resistance to pilling formation, which results in lowering the aesthetic comfort of clothing and can contribute to shortening the time of its application.

Taking into account the greater tendency to form pilling phenomena for BG 1003 fabrics, it is suggested to shorten the process of using clothes made from them in relation to the standard time of use of products with a predominance of polyester fibres in the raw material composition.

- Material resistance to light according to EN ISO 105-B02:2014-11 [37];

Obtained tests results of colour resistance to artificial light indicate good colour durability of KG 308 and BG 1003 fabrics in both colour variants. The durability of fabric coloration, designed for working or protective clothing, for light is a particularly important indicator describing the utility durability of clothing, due to the possibility of long hours of exposure of workers using this clothing to sunlight (work in the construction sector, including outdoor).

- The resistance of water vapor according to standard EN ISO 11092: 2014-11 [16];

Tested fabrics with the symbols KG 308 and BG 1003 in both colours meet the requirements of EN ISO 20471: 2013-07 High visibility clothing - Test methods and requirements within the maximum possible water vapor resistance of 5 m<sup>2</sup>Pa / W. For the selected fabrics slightly different results were obtained, as in the case of fabrics of KG 308 in both dyes, the value of the water vapor resistance index was about 5% higher (greater resistance in the transport of water vapor from the sub-microclimate to the external environment) than in the case of fabrics with the symbol BG 1003.

**Despite meeting the requirements of the EN ISO 20471:2013-07 standard [6], differences in resistance values of water vapor at the level of 5% of value can be felt by users of clothing, in particular in conditions of intense physical effort. The ability to transport water vapor through clothing is the most important feature describing comfort parameters of use, defines the product's ability to penetrate water vapor coming from the sub-microclimate outside the clothing system, which ensures moisture balance and what**

**is related to thermal (protection against overheating as well as excessive cooling of skin surface of the user's clothing).**

The water vapor resistance index corresponds to the evaluation of sweat discharge in the experimental use. It should be noted, however, that the tested fabrics will not be in direct contact with the user's skin and have a very tight structure as the outer layer of workwear clothing.

- Air permeability according to standard EN 9237:1998 [43];

This indicator in the applied research translates into the assessment of thermal permeability and thermal insulation of products. The ability of the material to permeate the air depends on its structural structure, including thickness, type of stitch/weave used and interlacing accuracy. When comparing the results of the air permeability test for navy blue fabrics, the values obtained for the BG 1003 fabric are about 13% higher compared to the fabric of KG 308. KG 308 fabric in navy blue colour is characterized by better breathability, providing greater comfort of use and tendency to transport of water vapor from the sub-microclimate to the external environment. Despite the relatively small difference in the air permeability values obtained for both navy blue fabrics, during intense conditions of clothing use (physical work), this difference may be decisive for the preservation of thermal comfort and humidity conditions.

In the case of yellow fabrics, the air permeability values for the KG 308 fabric are about 10% higher compared to the BG 1003 fabric. However, in both cases the values obtained are at the level of 90-100 mm/s, which proves the good breathability of the mentioned fabrics.

- Seam strength according to standard EN ISO 13935-2:2014-06 [28];

In order to assess the strength of seams, reference is made to the requirements contained in the standards for protective products, i.e.: **EN ISO 11612:2015-11** Protective clothing - Clothing for protection against hot and flame factors - Minimum requirements for efficiency [55] or **EN ISO 11611:2015-11** *Protective clothing for use in welding and related processes* [56] in which the test methodology used and the scope of requirements are identical. Standards mentioned above indicate the minimum value of seam breaking force as 225 N. The seams made on all tested fabrics met the requirements of the above-mentioned higher standards, which proves the high resistance of seams used in the work clothes to mechanical damage.

When comparing the different joining methods used for the materials, the highest values of the seam strength can be indicated for the fabric stitched with the side seam.

- Resistance to washing and drying according to standard EN ISO 6330:2012 [14];



In order to assess the durability and appearance of the fabric structure and evaluate the functionality of the proposed electronic devices fastened in two different ways in workwear clothing, for selected fabric samples connected with RFID tags a conservation process in accordance with the clothing maintenance label was carried out in the following variants:

- 5 cycles of washing and drying,
- 50 cycles of washing and drying.

Additionally, the degree of colour change of fabrics after the maintenance processes was assessed in accordance with the EN 105-A02 standard Textiles - Colour resistance tests - Grey scale to assess the change in colour [24].

On the basis of the description of the fabric appearance, it was shown that materials with 65% synthetic raw material (KG 308 fabrics) retain high colour fastness after 5 and 50 maintenance cycles (grades 4-5 grey scale). Furthermore, the assessment of the surface structure of fabrics KG 308 after washing and drying processes (both 5 and 50 times) showed no changes or only slight changes in the appearance of the fabric. In summary, this indicates their high aesthetic value and high durability.

Fabrics with a raw material composition with a predominance of Cotton fibres showed slight changes in the surface structure after 5 times washing and drying, and after 50 times maintenance processes, these changes were already noticeable, and permanent creases were created. In terms of assessing the degree of change in the grey scale, after 5 times washing it was at the level of 3 to 4, and after 50 washing and drying it was only 2 to 3.

The obtained test results show a lower useful life of BG 1003 fabrics compared to KG 308 fabrics, which is manifested by lower fabric resistance to multiple maintenance cycles resulting in aesthetic reduction of clothing made of these fabrics.

- Evaluation of resistance to washing and drying processes of RFID tags used:

The assessment of the resistance of electronic devices to the maintenance conditions was carried out in the "KRYSTIAN" Company - project partner. Checking the activity of RFID tags was performed by reading data for each of the tests. Trials from 3 to 6 pieces from the prepared assortments of TenCate Tecawork™ KG 308 navy blue and TenCate Tecawork™ BG 1003 navy blue, combined in two different ways with RFID tags, were rated positively in terms of electronic device operation and its mounting method.

## **Summary**

Research realized allowed for a comparative assessment of selected fabrics in terms of usable and physiological properties of materials and durability of the target electronic components, guided by the intended purpose of the products. The test results confirmed that the fabrics of KG 308 and BG 1003 meet the requirements of the relevant standards regarding workwear and protective clothing as well as additional parameters describing the comfort of use, including the aesthetic comfort of clothing. In addition, the research results have complemented knowledge obtained from functional workwear clothing research.

Regarding the obtained test results of the fabrics in question, TenCate Tecawork™ KG 308 fabrics (with a surface area of 245 g/m<sup>2</sup> and a raw material composition: 35% Cotton + 65% Polyester), in both colour variants, are characterized by high resistance to mechanical factors, colour resistance to light and durability of the surface appearance after repeated washing and drying. TenCate Tecawork™ BG 1003 (surface area of 255 g/m<sup>2</sup> and the composition of raw materials: Cotton 65% + Polyester 35%), obtained slightly better values for indicators defining biophysical properties. It is important to consider the values that are responsible for the safety, functionality and physiological comfort of people who, to a large extent, carry out work that requires high physical activity.

With a view to increasing the physiological comfort of the new prototype of workwear clothing, it is suggested to use fabrics with lower resistance to multiple maintenance or pilling processes, however, providing better usage comfort of clothing in terms of water vapor transport and excess heat from the subzone microclimate to the external environment. The selected RFID tags both in terms of their mounting and resistance to the maintenance carried out in several dozen cycles (washing and drying), meet the expectations assumed in the project and can be used in the construction of new work wear clothing.

#### **4. SURVEY OF EXISTING WEARABLE TECHNOLOGIES AND NEEDS OF END-USER SEGMENTS (IW, Poland)**

In recent years, the use of electronic systems in textiles has been developing very dynamically. The advancement of technology gives new possibilities for data transfer, manufacturing of microsensors, integration of electronic systems, methods of their supply and incorporation in clothing. The trend of implementing multifunctional systems is found in clothing used in many industries. It is possible to design differentiated measurement compositions depending on the intended use of clothing. The new multifunctional products have the ability to monitor changes related to human activity and environmental conditions, with a view to supporting physiological functions, ensuring safety and health protection, by controlling vital functions or warning about danger. The data transfer potential, in order to transmit the acquired information, increases the efficiency of communication between several centres. In the literature there are many examples of the use of textronic solutions in specialist clothing for the protection and safety of users in such areas as: medicine, rescue (mountain, guards, mining), army, astronautics, energy, tourism, sport, but also in commonly used clothing and following for fashion trends, including clothing designed for entertainment and relaxation with a modern design and impressive finish [57,58,59,60,61]. Numerous products show that with the innovative textronic solutions it is possible to design specialized workwear clothing extended with new properties supporting its functionality through multi-directional protection of man in the work environment.

According to preliminary statistical data from 2016, published by the CSO in March 2017, the construction industry was ranked fourth among the industries (after industrial processing, trade and repair of motor vehicles and transport), in which there is the largest number of people injured every year in accidents with work [61].

Due to the high accident rate in the construction industry, it became known with the subject and directions of development of innovative solutions. In order to pre-assess the use and / or modification of the proposed solutions in workwear and protective clothing, an analysis of existing products that would potentially increase the safety of employees was performed.

The article is of an illustrative nature related to the initial review of this subject, in order to acquire knowledge that will be able to be used in the design work of products intended for the needs of employees in the construction industry.

In order to justify the choice of examples of textronic solutions that increase the multifunctionality of work wear clothing of construction workers in the area of security, the threats occurring in the work environment and the needs of employees and employers were identified.

#### **4.1. Identification of hazards for employees in the construction industry**

Statistical data of the Central Statistical Office, published in the signal study of 2016 show the percentage breakdown of: events causing injuries, causes of accidents at work, activities performed by the victim at the time of the accident and the location of the injury.

From the data shown, the main cause of accidents at work is abnormal behaviour of the employee during the most frequent movement, as a result of which in most cases a collision with or impact on a moving or stationary object takes place, and the most exposed to injuries are the upper and lower limbs, which demonstrates the special need to protect them [62].

GUS statistical data from previous years presented in the study [63], present the situation of the construction industry in the following way:

- more than half of the victims were persons working a year and less than a year,
- most often accidents on construction sites were made by workers performing raw work, workers at finishing works: welders, tinsmiths and assemblers of metal structures as well as electricians.

On the existing situation threatening the life and health of employees is mainly influenced by the increase in employment in construction companies, small and economically weak, and employee turnover, and as a consequence, lack of people with adequate experience and professional qualifications.

The most common accident circumstances are:

- slipping, stumbling,
- impact by falling objects from above, e.g. by transported, assembled and ejected building materials; elements of scaffolding and formwork, dismantled elements of the building structure, etc.
- hit by the object at the same level,
- the victim's fall from a height,
- falling into a recess (excavation),
- crushing by the dismantled elements of the building's structure,
- irregularities related to electricity,

- gas explosion or fire,
- dust covering eyes.

Construction workers are exposed to a number of harmful factors during their work, which include:

- chemical agents (chemical substances and their mixtures, including carcinogens),
- physical factors (noise, vibrations, dusts, fumes, microclimate and UV radiation),
- mechanical factors (collision with or impact to / through a stationary or moving object, contact with an acute, rough, rough object),
- psychophysical factors (confinement, crushing, physical load and neuro-physiological load and thermal load, work at heights and maintenance of construction equipment, poor health) [64].

#### **4.2. Innovative textronic solutions**

The environmental interview shows that the most important need of employees is to adapt the clothing to the silhouette in a way that does not impede the performance of work, by limiting the range of movements or visibility, while maintaining the comfort of using clothes during long-term work in diverse environmental conditions. The employer, however, drew attention to the willingness to use the latest technologies in clothing in order to increase the monitoring of work and the safety of employees, increase communication and streamlining the supply chain while maintaining the most important criterion for the selection of clothing which is good material and seam strength.

Following the identification of threats, needs analysis and exploration of technological possibilities, selected examples of textronic solutions have been presented that can be implemented into work and protective clothing for employees of the construction industry, based on:

- systems improving the visibility of employees,
- heating systems with temperature regulation in order to improve the comfort of using clothes, during long-term work in various environmental conditions,
- sensors monitoring the presence of harmful gases in the work environment,
- external temperature sensors,
- height and distance sensors,
- communication system (RFID technology),
- GPS (Global Positioning System) system,

and possibilities: implementation of electronic systems in clothing, their integration, power supply and maintenance methods.

### 4.3. Visibility level optimization

Warning products are commonly used where there is a risk of visibility for the employee. Using them does not guarantee full safety, but significantly reduces the risk of an accident. A commonly used product for this purpose is a warning vest, which in the summer reduces the user's physiological comfort. Therefore, textile braces (Fig.4.1. a) is the proposed solution, which use reflective tapes and additional signalling elements in the form of flashing LED diodes. The construction of braces reduces the surface interfering with the user's comfort and gives the possibility of placing the electroluminescent panel with illumination on the back side of the product. Existing solutions also include overalls, jackets and even T-shirts, where panels of a programmed message are placed anywhere in the product (eg "release - work on the road") [65].



*Figure 4.1. a), b), c) Examples of textile harnesses in which reflective tapes and additional signalling elements are used, i.e. flashing LEDs [65]*

### 4.4. Heating clothes using electronic systems

Another solution for textronic applications is clothing with active thermoregulation equipped with integrated heating systems with temperature regulation function. Solutions of this type are known from suits for divers, clothing for emergency services, extreme sports clothing and other specialist clothing, which was designed for users undertaking various physical activities requiring greater or less activity in changing environmental conditions,

which is associated with uneven heat release process through the body (protection against overheating and cold) [66].

Among these solutions are:

- jacket with built-in active elements in clothing, in the form of six heating inserts, made of steel fibre yarn, in which the operation and adjustment is carried out using a measurement and control system, collecting data from temperature micro-sensors placed in two points of the human body - under clothing and in the outer part of clothing. Power supply of implemented integrated electronic systems is carried out by using a lithium-volt or a source of alternative energy, such as solar panels [67,68].

- jacket with active thermoregulation (Fig.4.2.) based on Omni-Heat Electric technology, which uses an advanced, internal heating system based on carbon fibres, powered by the latest generation lithium-ion batteries, placed in special, internal pockets of the jacket. In order to activate the heating function, a button is placed next to the jacket's slider, after pressing it, its interior is quickly warmed up and allows to keep warm in the most unfriendly conditions for 5 hours. The use of the thermal insulation layer Omni-Heat™ and the lining Omni-Heat™ Thermal Reflective, causes the reflection of heat towards the body, thus acting like a thermal blanket. The button activating the function is equipped with a diode signalling system activity and one of three heating levels. The system's battery power is supplied via a USB connection, and it can also be a source of power for other devices such as a mobile phone or mp3 [69].

- a jacket with an electric heating system having 4 electric heating panels ensuring uniform heat distribution, a control device in the form of a remote control and a cable for charging the battery (Fig.4.3.). Heat-conducting panels are able to participate in the washing process and have been placed in a visible manner on the inside of the product together with the connected battery, which is a non-resistant element for the maintenance process. The jacket has an indicator that controls the battery level, while the reheating process takes 15 minutes and lasts for 3 hours [70].



*Figure 4.2. Jacket with active thermoregulation Electro Amp™ [69]*



*Figure 4.3. Jacket with an electric heating system [70]*

Specialized clothing for military services are another example, which, apart from systems for monitoring vital functions, built-in location (GPS) and thermovision elements, have a system that maintains a constant microclimate of the body through heating and cooling [71].

#### **4.5. Sensors monitoring the work environment**

There are many factors that cause danger when doing construction work in the open space. A quick reaction in the event of an emergency determines about the health and often the life of the employee, therefore, the control of the work environment is important. Currently, solutions in specialist clothing are known, which help users especially during activity in extremely difficult conditions. Such solutions include systems for monitoring the environment and transmitting information about the threat through direct signalling by means of signals or through special video interfaces.

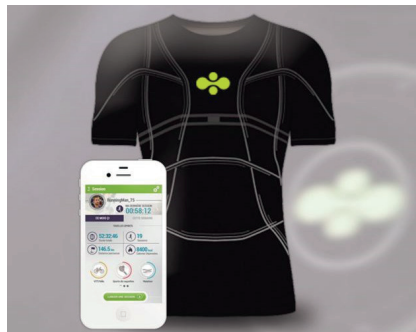
The Gorix Sens-A-Strip - developed temperature measurement system is one of the possible solutions used in sudden temperature changes in the case of, for example, fire or hot air, which uses linear dependence of the electrical resistivity of the fabric on the temperature.



A thin strip of this sensory fabric informs about sudden changes in temperature through a warning system in the form of a sound signal [72].

Similar types of elements integrated with clothing can also detect radiation levels (environmental pollution) in industrial conditions or levels of harmful gases. The use of active or passive relays integrated with clothing enables reliable and early warning, for example of heavy machinery operators, in case when the crane with the load will be above the worker [73].

An example of using many electronic components in one system is a clothing package intended for a firefighter which prototype was made in Poland. Sensors monitoring physiological parameters, body temperature and the underclothing temperature, i.e. the outside temperature, the oxygen concentration level, the concentration of harmful gases, have been built in it. The clothing package also uses appropriate power systems and tools for direct communication and data transfer [60,74,75].



*Figure 4.4. T-shirt with a built-in GPS module [76]*

There are also examples of specialist clothing such as clothing for mountaineers and a traveller equipped with an electronic compass and integrated sensors: measurement of altitude and latitude (GPS module), temperature [71].

These functions make it easier to locate the employee at the accident site, find him or her, and thus increase the chance of saving.

#### **4.6. RFID communication system**

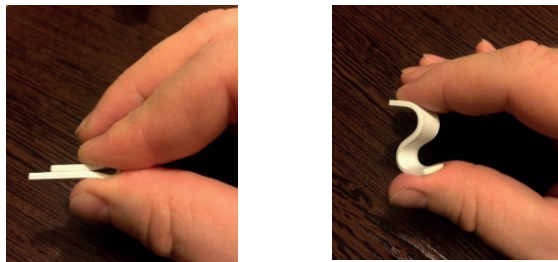
According to a preliminary analysis of the needs of employers, it is justified to look for solutions that allow monitoring the time of use of personal protective equipment (storage, use and maintenance). The proposed RFID Radio Frequency Identification technology is used to

automatic data identification, employee records, information about for example products without the need for direct access and wireless data transfer [77].

With regard to employer surveys, one of the proposals is the use of RFID technology, i.e. marking of personal protective equipment with electronic tags (tags), in which the built-in antenna transmits the stored data to the reader and then sends it to the database on the server.

At present, RFID technology is used to improve the supply chain and the destination of clothing for a specific employee [78].

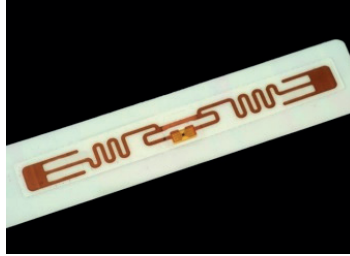
The system makes it possible to: determine, appropriate to the degree of wear of personal protective equipment, maintenance periods, repairs and replacements, registration of the "life cycle", analysis of costs related to the purchase by division of department / work positions, statistics and cost planning, taking into account the location of costs, identification and records of people and property.



*Figure 4.5. Textile-silicone, flexible and waterproof RFID sensors [79]*

Currently, textile-silicone, flexible and waterproof RFID sensors of small size are on the market, which have the ability to rewrite data, functionality in harsh environmental conditions and resistance to high temperatures (Fig.4.5.) [79].

An example of other possible innovative textronic solutions is clothing, where the electrically conductive circuits and controls electrical systems was built into the material structure by use the weaving method. This method enabled the integration of many technologies, from microcontrollers, Bluetooth, memory cards, GPS and GSM, to RFID (Radio Frequency Identification) and biometric sensors [80,81].



*Figure 4.6. Solution using metallic conductive paints [82]*

Another option for the application of electrical systems is a new printing technique developed by scientists from Finland and China, using metallic conductive paints for textiles (Fig.4.6.), to develop innovative applications such as virtually invisible RFID tags in clothing [82].

RFID technology to monitor work and supply chain processes is used by traditional clothing manufacturers, tire storage companies [83], and laundries [84].

RFID technology is widely used and can have a positive impact on the construction industry, reducing occupational risk and communication of employees.

#### **4.7. Power supply**

In order to ensure proper operation of the textronic system, it is necessary to apply the appropriate power supply. Among the offered power sources, the simplest and the cheapest solution are lithium-ion batteries, reusable. Their use is connected with difficulties resulting from the lack of continuity of operation (discharging) and large dimensions, stiffness and the necessity of their disassembly before the maintenance process. A number of scientists conduct research in the field of FPS (Fibrous Power Supply), or technology for the production of textronic electricity sources, based on fibres. FPS products are characterized by lightness, flexibility and a large electric charge that gives the possibility of storing electric energy and powering other devices [85].



*Figure 4.7. Jacket equipped with solar panels enabling recharging of the battery via the USB port*  
[86]

An example of the above solution is a jacket equipped with solar cells, allowing to recharge the batteries hidden in the pocket via the USB port (Fig.4.7.) [86].

In France, however, research is carried out on clothing that will have the ability to self-energize in the washing process [87].

## 5. INTEGRATION OF SAFETY SENSORS INTO WORKWEAR

Prototype of work apparel with a sleeve-integrated electromagnetic field sensor and a warning signal sensor will be developed. The developed system is intended for work with electrical equipment in direct current industrial electrical supply networks in order to improve work safety (as an addition to individual work safety equipment). This is important in carrying out unforeseen tasks in electrical distribution of industrial systems where unplanned disconnection of a consumer, such as a CNC machine, can have negative consequences on the production process or even cause significant damage to the equipment.

The operation principle of smart textiles is a DC electromagnetic sensor embedded in a cuff edge, bringing it nearer to the consumer power supply cable, if current runs through it, information is sent to the electronic unit and a sound signal is transmitted, warning the user of a potential risk.

The product is subjected the following characteristics:

- protective/warning properties – protects against environmental exposure, alerts on existing electrical threats;
- hygienic properties – appropriate microclimate;
- fit, physical comfort – size fits for the wearer, lightweight, comfortable to wear, ease of movement, details such as pockets, fasteners are designed to meet the requirements for safety and ergonomics;
- psychophysiological comfort – materials cause no discomfort, comfortable to wear, all electronic components are insulated, their location is appropriate for the ease of use;
- aesthetic qualities – corresponding to fashion trends;
- longevity and reliability;
- health friendly.

Smart work clothes are subject to the following requirements:

- work clothes should not encumber freedom of movement and also endanger the wearer's health and/or life;
- chosen materials are in compliance with the quality, hygiene and health requirements; electronic components do not pose a threat to health and/or life;
- location of electronic components cause no discomfort and pose no additional danger to the wearer;

- electronic components must not cause a threat of electric shock;
- the product is repeatedly washable, the energy source and the sound signal sensor are easy to disassemble before washing, other electronic components are insulated and washable;
- the description of the product covers the use and disposal of the energy source (battery or accumulator) in accordance with environmental protection requirements.

The designed work clothes must comply with the following standards and directives of the European Union:

- EN ISO 13688 Protective clothing. General requirements [2];
- CEN/TR 16298 Textiles and textile products. Smart textiles. Definitions, categorisation, applications and standardization needs [88];
- EN 50110-1 Operation of electrical installations – Part 1: General requirements [89];
- EN 13921 Personal protective equipment – Ergonomic principles [90];
- EN 60335-1+A13 Household and similar electrical appliances. Safety Part 1: General requirements [91];
- EN 60335-2-29:2004+A11:2018 Household and similar electrical appliances. Safety. Part 2-29: Specific requirements for battery chargers [92];
- EN 60086-4 Primary batteries Part 4; Safety of lithium batteries (IEC 60086-4:2014) [93];
- EN 62133-2:2017 Secondary cells and batteries containing alkaline or other non-acid electrolytes – Safety requirements for portable sealed secondary lithium cells, and for batteries made from them, for use in portable applications - Part 2: Lithium systems (IEC 62133-2:2017) [94];
- The European Union Low Voltage Directive 2014/35/EU Low Voltage Guidance [95].

### **5.1. Safety sensors in workwear – development trends and innovations**

Continuous and rapid progress in technological development requires development of new competences and skills, while creating new working conditions. Nevertheless, the human factor does not lose and will never lose its significance, therefore encouraging the need for a comprehensive, practice-backed notion that investment in creating safe working conditions and securing health of employees eventually pays off, thus promoting productivity and labour satisfaction, minimizing the existing and predictable risk factors, creating socially responsible society – shaping a people-focused working environment. It is important to set up a preventive

plan and ensure its implementation by guaranteeing the most appropriate and safe conditions for employees, especially in high-risk occupations, such as firefighters, military forces, medical professionals, etc., in order to foresee and prevent accidents, catastrophes, as well as to facilitate successful rescue operations [96].

Thanks to high technologies, workwear not only protects the wearer from environmental hazards, but also ensures maximum performance and agrees with design requirements – modern, fashionable, high-quality, and functional apparel. “Future workplace” – wearable technologies, digitalisation, software, integrated sensors to monitor human health and vital signs, back-protecting and performance enhancing “exoskeletons” for people with reduced mobility, as well as for military needs, responsive materials adaptable to certain conditions and meet all the comfort requirements while protecting against environmental risks (see Fig.5.1) [97,98].



*Figure 5.1. Left to right: ProeTEX project (Smartex, Italy); Smart personal safety equipment (Seebo); Next generation uniform (DHS) [97,98]*

Smart textiles have the ability to detect and respond to various irritants, such as changes of weather conditions, mechanical, chemical, electromagnetic, etc. factors, to accumulate and save energy, to reflect light, etc. In industries such as military defence, healthcare, sports, mechanical engineering, etc., the interest and demand for this kind of smart textiles and solutions is constantly growing. Work/protective clothing of the new generation should be comfortable to wear and easy to care, therefore most significant representatives of the industry continuously work on development of integration of new, ever smaller and more powerful technologies into clothing. The use of electronic connections, printing of sensors onto clothing, using electrically conductive inks is increasingly developing, making smart clothes lighter, more functional, more comfortable, additionally providing feedback – by reporting on the wearer's health status, location, etc. [97,98]

Leading players in manufacturing of textiles intended for work/protective apparel, the following basic requirements set out for the clothes: increased strength, stretch, freedom of movement, easy care (machine washable), fast drying, ensuring an appropriate microclimate, breathing, high durability, long wearlife. In addition to these requirements, the clothes are treated with a coating intended for the respective purpose, for example, to make them fireproof, moisture-proof, dirt-repellent, antimicrobial, protective against chemical and radioactive contamination, etc. [99].

At the global and national level, work security issues and requirements, analysis of the current situation and the search for solutions are important given that, according to Eurostat data, for example, Latvia shows one of the highest rates of injury and death at work in the European Union (3rd place) [100].

Innovations and investments in the field of smart textile materials and textile systems are most characteristic in manufacturing of personal protective equipment (including workwear) and in the field of military, as well as in healthcare and sports. The global market of smart textiles for military and protective clothing accounts for more than a quarter of the total market of intelligent materials. Determination of the wearer's location, monitoring of physiological data, cooling and heating systems, provision of communication, energy storage and production are main trends in the application/integration of smart textiles and wearable electronics into workwear [96].

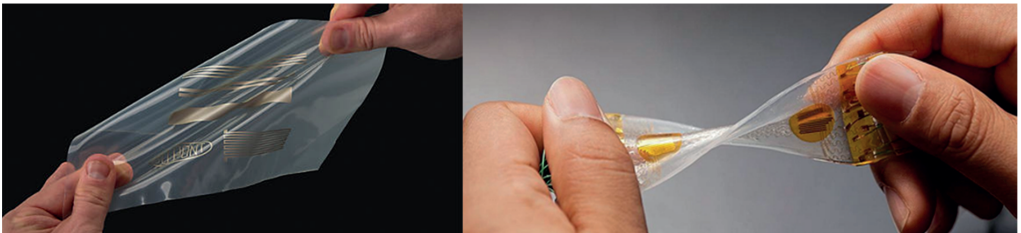
Main factors determining the development of innovations in workwear are as follows:

- user's needs and desires;
- overall position towards labour protection and human rights;
- environment protection requirements.

Over the last decades, not only functionality, namely, the ability to perform protective functions for which each particular product is intended for, but also the user's comfort, design aesthetics, and the fit of the product are being considered in development of work clothes. Rapid technological advancement allows focusing on these aspects. Particular attention is being paid to air and moisture permeability of the material, lightness and tactile properties of the cloth, ease of movement and pleasant microclimate, thus eliminating the potential risks that might occur during execution of duties, such as overheating, movement restrictions, additional weight load, etc. [98,101]



Methods for integration wearable electronics in clothing should be such that they do not impede and do not trigger additional risk, do not restrict movements and do not cause unnecessary heaviness. In addition, the product must be easy to clean and fitted with electronic components that are easily removable or repeatedly washable. One of the key issues is the hardness of the electronic components, as well as their low flexibility and extra weight. This leads to the search for solutions to make electronics more suitable for integration into clothing. Printing of electronic components on fabric, as well as the use of conductive threads is getting increasingly popular, solid electronics are getting smaller in sizes and, when sealed in isolating material or laminated, they become washable (see Fig.5.2) [101].



*Figure 5.2. From left to right: Printed electronic components (DuPont); Flexible sensors in silicone (MC10) [101]*

When designing electronics-containing clothes, attention should be paid to their safety in regard to human health and/or life – integrated electronic components should not be irritating or toxic/ reactive. The electromagnetic radiation that may result from their operation should be minimized, for example, by using reflective materials. Products must comply with ISO standards and European Union requirements (see introduction of Chapter 5). Such products are also subject to additional ecological and environment protection requirements in order to avoid causing dangerous environmental pollution when the product has lost its functionality and discarded. When disposing garments with integrated electronic components, it is necessary to sort all of the components by types of waste and accordingly to process them taking into account requirements and instructions for each individual component, such as batteries or metal components.

Regardless of the high funding for the development of smart textiles and systems, there are relatively few products put into production and actually used in the working environment. The average costs for development and manufacturing of such products are relatively high.

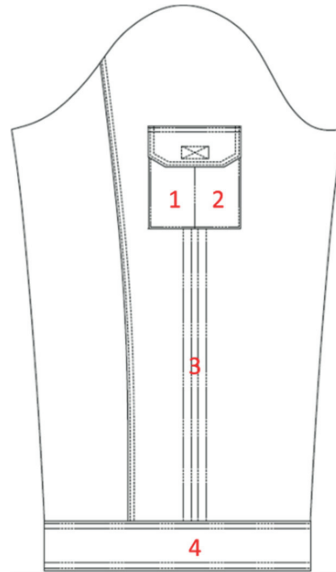
However, since more and more attention is being paid to work safety and comfort at work, development and improvement of intelligent workwear/protective clothing is one of the priorities of the industry.

## 5.2. Technical description of prototype

Within the framework of the study, a prototype of work apparel with sleeve-integrated electromagnetic field sensor and alerting signal sensor will be designed. The electrical and electronic part of the system includes a DC electromagnetic sensor, conductive threads and metal snap buttons, an electronic unit and a power supply element. The technical drawing of the product is shown in Fig.5.3, while the location of electronic components – in Fig.5.4.



*Figure 5.3. Technical drawing of the product (front view and back view)*



*Figure 5.4. Location of electronic components: 1 – power supply; 2 – electronic unit (with a switch and an alerting signal sensor); 3 – conductive threads with metal snap buttons; 4 – DC electromagnetic sensor*

The DC electromagnetic sensor is located in the welt piece of the cuff edge of a set-in sleeve, with four electrically conductive threads attached to it which then is sewn to the inner side of the oversleeve. The power supply element and the electronic unit are fitted in a two-piece removable pocket with a flap. The pocket is attached with a hook&loop tape and metal snap buttons that connect the electrical circuit. The operating principle of the system is as follows: when the sensor is brought nearer the consumer power supply cable, alerting sound signal goes off if there is electric current in the cable. The magnetic field changes the sensor resistance values as a result of which the resistance at the bridge outlet changes the voltage. These voltage alterations are amplified by a differential amplifier (voltage difference amplifier) with an amplification factor of approx. 1200. The comparator compares the amplified signal with the set signal, and if it is larger, then the signal is transmitted to the sound amplifier and an audible sound signal goes off. Therefore the electronic unit consists of an amplifier, a comparator and an acoustic signal amplifier. The block diagram of the system is shown in Fig.5.5. The entire circuit is powered by a 9V direct voltage (standard 9V battery).

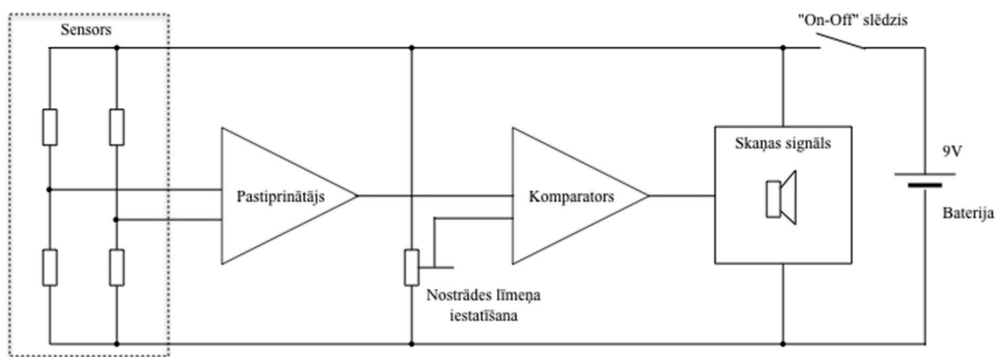


Figure 5.5. Block diagram of the system (Sensor, amplifier, Set-up of actuation level, comparator, Sound signal, "On-Off" switch, 9V battery)

The DC electromagnetic sensor is covered with an electrically insulating varnish and insulated by means of hot melt glue so that it can be repeatedly washable, while the power supply element and the electronic unit inserted into the pocket must be removed from the product before washing. The section schemes of the technological components containing electronic components are shown in Fig.5.6., where the first image illustrates integration of the electromagnetic sensor, the second one shows integration of the conductive threads, and the third one – pockets with integration of power supply elements and electronic units.

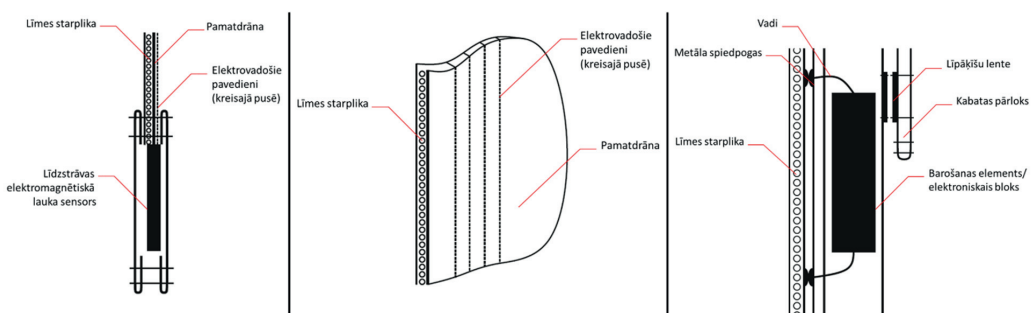






Figure 5.6. Section scheme of technological units (DC electromagnetic field sensor, adhesive interlining, basic layer, conductive threads (on the left side) / adhesive interlining, conductive threads (on the left side), basic layer / adhesive interlining, metal snap buttons, wires, hook&loop tape, pocket flap, power supply element/electronic unit)


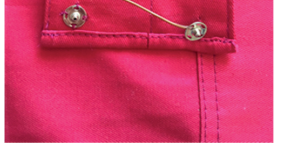
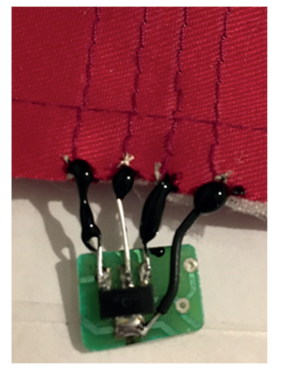


### 5.3. Description of the prototype development process and used materials

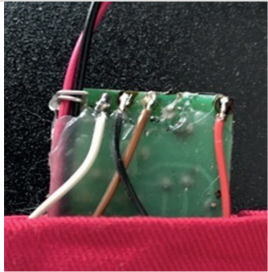

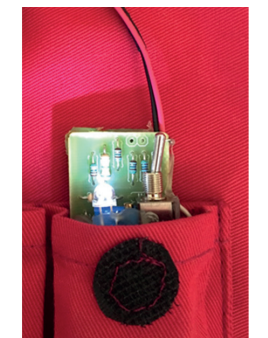
When the constructive and technological designing of the product is completed, parts are cut out and prepared for further processing. It is most convenient to integrate electronic components while parts are not yet sewn together. The production process is shown in Table 5.1.

Table 5.1.

Technological sequence of prototype production

Item	Technological operation	Image
1.	Sew conductive threads on the left side of the oversleeve	
2.	Glue down the adhesive interlining, isolating conductive threads from contact with a flesh	
3.	Attach snap buttons (connecting with electroconductive threads)	
5.	Prepare pocket and attach pocket flap	

Item	Technological operation	Image
6.	Attach hook&loop tape to the pocket	
7.	Solder down wires to one side of a snap button (in total 4 snap buttons), insulate them and embed them into the back of the pocket	
8.	Connect electroconductive threads with DC electromagnetic sensor, cover mounting points with conductive paint, thus strengthening the joints and providing stable flow of current	
9.	Cover electromagnetic sensors and electroconductive electrodes with electroconductive threads with hot melt glue on all sides (other insulation materials and methods can be used for industrial production), so that the sensor is protected from moisture during washing	
10.	Create an electronic unit, connect a switch and a LED that signals when the device is turned on, as well as a warning sound amplifier.	

Item	Technological operation	Image
11.	Prepare wires that were previously soldered down to snap buttons and embedded in a pocket bag	
12.	Connect the power supply element and insert the device into the pocket	
13.	Turn on the electronic unit and check its operation	

The materials used for the prototype and their approximate costs are summarized in Table 5.2. When manufacturing products in an industrial way, materials should be selected according to quality requirements and standards, and costs should be calculated according to wholesale prices.

Table 5.2.

## Materials used

Item	Material	Image	Provisional price, EUR
1.	Cotton fabric (100%)		10.90 EUR/m
2.	Adhesive interlining (100% PES)		0.85 EUR/m
3.	Thread (80, PES)		1.75 EUR
4.	Electroconductive thread		37.24 EUR/360 Yards
5.	DC electromagnetic field sensor		6 EUR
6.	Electroconductive paint		8 EUR/10ml
7.	Battery		2.70 EUR



Item	Material	Image	Provisional price, EUR
8.	Connector		3.98 EUR
9.	Metal snap buttons		0.10 EUR/pcs.
10.	LED (white)		0.09 EUR
11.	Switch		1.80 EUR
12.	Warning sound signal transmitter		4.12 EUR
13.	Electronic unit		3.07 EUR
14.	Wires		1.00 EUR/m
15.	Hook&loop tape		0.85 EUR/m

#### **5.4. Testing of the prototype and analysis of the results**

The course of the experiment:

1. Connect all elements.
2. When the switch is turned on, the LED diodes light up, but the sound signal does not go off.
3. If the sound signal sounds goes off, level of operation is to be elevated until the sound signal disappears.
4. The sensor operation is checked by nearing the permanent magnet, which in this case emulates the magnetic field of the direct current.

The outcome of the experiment:

- Since the performed experiment confirmed work capacity of the system performance, the experiment is considered to be successful.
- Conclusions:
- The system is efficient if the sensor detects the test magnet signal in a distance of at least 2.5 cm (according to an explanation provided by RTU IEE experts).

#### **5.5. Conclusions, directions of the idea development**

- Rapid technological development, updating of safety and environmental factors contributes to the improvement of workwear /protective clothes, as well as advancement of personal protective equipment and their compliance with requirements for modern working environment.
- Ever new smart looking solutions to be integrated into clothing to improve work safety, reduce accidents and deaths at work, and to increase overall employee satisfaction and therefore quality of work have been searched.
- The central focus is on man and his desires and needs; technologies are developed based on the requirements of the human and the new working environment. In the development of workwear, a lot of attention is paid to its functionality and comfort, as well as aesthetic requirements.
- Garment-integrated electronics are becoming smaller and lighter to ensure their flexibility, electronic components are made on a textile basis or transferred on fabric with electric conductive paints/coatings. These kinds of wearable electronics are washable and more comfortable to wear.

- Within the framework of the work, a prototype of workwear with sleeve-integrated electromagnetic field sensor and a warning signal sensor was developed. The implementation of the idea was successful, in the result of the experiment the prototype proved its functionality and compliance with the requirements.

- Possible product development directions:

- to use wireless charging as a power supply, thus enhancing the product's functional properties as well as ecological requirements;
- to use electric field sensors also for AC power supply networks;
- to supplement the sensor so that it can also detect also the AC electric field (voltage);
- to improve the integration of equipment, for example by using industrially embedded snap buttons instead of attachable snap buttons;
- to solve the integration of the power unit and the electronic unit in such a way that the pocket bag in which they are inserted could also be washable (the inserted electronic system should be removable).
- to develop a system to enable the integrated electromagnetic field sensor to be used as an electric current meter by sending data to a smart device or by inserting a textile display on a sleeve trimming.

## **6. INCORPORATION OF ELECTRONICS INTO GARMENT BY 3D PRINTING**

Introduction of smart technologies directly into garment is decided to be suitable approach as it is easy for the end user, it also eliminates the human factor (e.g. forgetting) and therefore advances safety at work place, especially in chemical industry.

Additive manufacturing technology has potential in customization of large-scale textile material production. Fused Deposition Modelling (FDM) 3D printing technology is cost effective, material efficient, agile, several materials can be combined in one-step process and therefore can be utilized in integrating electronics into smart textiles [102]. The technique has the ability to provide complicated 3D geometries from several materials to create systems directly on fabric, which are not possible to design with traditional 2D printed methods. We have studied FDM technology for two different applications: printing of antennas and circuits using electro conductive filaments and encapsulating electronic components. FDM technology for encapsulation of electronics onto textile is fast and cost effective prototyping of the smart solutions for textile industry and also enables manufacturing of complex and conveniently customizable electronic structures on textile [103].

For further utilization of technology, washing resistance, wear resistance, flexibility and adhesion of the print on the textiles plays the most important role. The main goal of this work is to test properties of the prints on the textile substrate.

This report study properties of prints using thermoplastic filaments on 2 most common for work wear textiles - blend 30% cotton/70%PES, and 50% cotton/50% PA); materials are PLA, TPU and conductive PLA (Graphene and Copper filled PLA). Prints on textile are tested for adhesion, flexing and abrasion resistance.

### **6.1. Materials and 3D printing method**

Material for 3D printing has been researched for few decades and commercialized under various type of products. Material properties and 3D printing method are main factors for good adhesion of filaments on fabric. This chapter presents theory of material and practical methods for 3D printing with PLA, TPU, Copper PLA and Graphene PLA. Also, method for peeling test, abrasion test, flexing test, washing test etc. are introduced here.

### 6.1.1. Filament material

Polylactic acid or polylactide (PLA) is a thermoplastic, which is also biodegradable and non-toxic plastic. PLA is produced through many processes from acid lactic and many co-PLA exist in material such as PLLA, PDLA, PDLLA, PLDLLA. The general physical characteristic of PLA is studied in Table 6.1. In this experiment PLA is purchased from Minifactory inc, Finland in form of 1kg PLA stool, PLA string has 1,75mm in diameter. Decreasing crystallization temperature of PLA from 140 °C to 90 °C, density of PLA increases. Printing PLA at higher temperature (210 °C) makes density of melting PLA lower for better diffusion and adhesion [102].

Table 6.1.

Physical characteristic of PLA [102]

Thermal analysis data	PLA
Glass transition temperature Tg (°C)	50 - 65
Melting temperature Tm (°C)	173 - 178
Density (g/cm <sup>3</sup> )	1.24 - 1.3
Tensile strength (MPa)	0.04 - 32

Graphene PLA is black blended mixture of graphene and PLA. Conductivity of graphene PLA depends on printing temperature in range on 190°C-210°C. The material is purchased from Black Magic incorporation. Conductivity of graphene PLA is 0.6 Ohm-cm [104]. Graphene PLA is a hard material and easy to get nozzle clogging by expanding volume in heating. Therefore, graphene PLA should be removed from nozzle after printing and nozzle should be cleaned. During the experiment, graphene PLA performed as hard and low conductivity material. On the other hand, Copper PLA is combined of copper and PLA. The resistivity of copper PLA is 0.006 Ω cm. The filament is soft and non-elastic filament. Copper PLA was purchased from Multi3D LLC [105].

Thermoplastic polyurethane (TPU) is another class of a polyurethane plastics with many properties, including elasticity, transparency, and resistance to oil, grease and abrasion. TPU filament was purchased from Rigid ink, UK. As the glass transition temperature of polyurethane elastomers is quite high; therefore, this material has good thermal resistance and should be printed at high temperature (250°C) [106]. Blended TPU with other materials can improve

toughness, abrasion and oil resistance. These properties have provided this material good advancements for integrating electronics on textiles.

### 6.1.2. 3D printing

Few factors for better adhesion between printed materials and fabric, are printing speed, extruder temperature and bed temperature. Slower printing speed can make better diffusion of filament. In high extruder temperature, density of filament gets lower or volume of material expands which gives better bonding between filament and fabric. There was no significant effect of platform temperature found on adhesion when surface temperature was lower than glass transition temperature of printing material. Therefore, bed temperature was set to 80°C - 100°C for printing. Table 6.2. below shows the list of printing parameters that were used for 3D printing on textile in this work for all filaments.

Table 6.2.

**Printing parameter for PLA, TPU, Graphene PLA and Copper PLA**

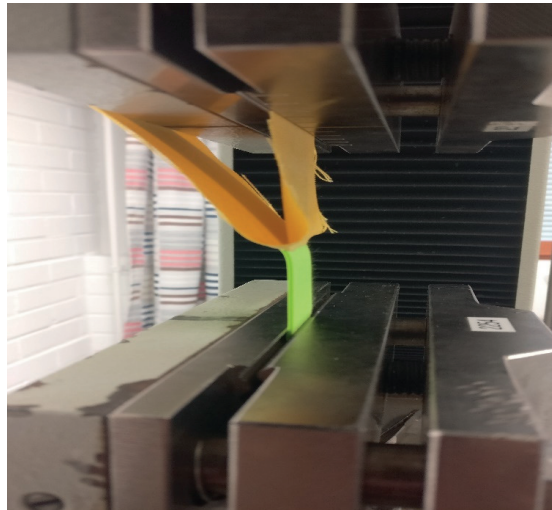
<b>Parameters</b>	<b>PLA</b>	<b>TPU</b>	<b>Graphene PLA</b>	<b>Copper PLA</b>
Nozzle diameter (mm)	0.4	0.4	1	1
Extruder multiplier	0.9 - 1.1	1 - 1.2	1.1	0.9 - 1.1
Extruder width (mm)	0.4	0.4	0.9-1	0.9 - 1
Retraction distance (mm)	0.8	3	0.5	0.5
Retraction speed (mm/min)	1800	1800	200	200
Layer height (mm)	0.05	0.2	0.1	0.1
Extruder temperature (°C)	210	250	190	140
Bed temperature (with fabric) (°C)	100	100	100	80
First layer speed (% of primary speed)	25	25	70	70
Other layer speed (% of primary speed)	25 - 60	25 - 60	60 - 80	60 - 80
Primary speed (mm/min)	2700	2700	2700	2700
EVPFSBP (mm)	-0.1	0.1	0.1	0.1

Extruder width is a number that computer sets as default as real width of one printing line. Low extruder width can make density of printed material higher, but risk of clogging also increases. Bed temperature is set to ensure platform temperature higher than glass transition temperature of material. Vertical position of extruder on fabric surface in the beginning of printing can be found by multiplying a total of first layer height (%) \* layer height (mm) then adding the distance between fabric and lowest point of extruder. This number defines the vertical position of hot-end at the beginning of printing. PLA has more adhesion with -0.1mm deep into fabric, while best printing method for Graphene PLA and Copper PLA is found at 0.1mm EVPFSBP.

## 6.2. Test methods of prints

### 6.2.1. Peeling test

Adhesion test is designed and executed according to ISO standard 11339:2010 (Adhesives - T-peel test for flexible-to-flexible bonded assemblies) with tensile testing machine. The separation speed of tensile machine is 10mm/min. The force is recorded and shown in N/100mm. The round shape in both end of sample makes sample easier to peel, and test results are not affected. The 5cm-end of sample is separated with fabric by using thermal tape, which is 0.06mm thick (Fig.6.1.) [107].



*Figure 6.1. Printed TPU peeling test sample*

There are 2 phases of peeling test. Firstly, for phase 1, table shows the development plan for best method of PLA printing on two fabrics, which are coded as F3 (black), F4 (blue). Variables in phase 1 are extruder temperature (T), layer height (L) and vertical position of extruder on fabric surface in the beginning of printing (H). All variable parameters are combination of H1 is printed on F3, and H2 on F4. Best methods in each fabric are determined and compared on the same fabric. Secondly, in phase 2, the best method for printing PLA is applied for fabric F1, F2, and other filaments are printed on F1 and F2.

In phase 2, table 5 shows the plan for peeling test with 2 variable parameters: filaments and fabrics. The printing method of PLA, TPU, Copper PLA and Graphene PLA in Table 6.3. are applied for fabric F1 (70% PE, 30% cotton), F2(50% PA, 50% cotton). Data is collected and analyzed in excel. Mean value of adhesion force for each test combination is presented along with error as standard deviation of at least three samples [108].

Table 6.3.

**Peeling test design phase 2**

<b>Filament</b>	<b>Fabric</b>	<b>Peeling test sample size (mm)</b>
PLA (phase 2)	F1, F2	200 x 25 x 0.5
TPU (phase 2)	F1, F2	200 x 25 x 1.5
Graphene PLA (phase 2)	F1, F2	200 x 25 x 0.5
Copper PLA (phase 2)	F1, F2	200 x 25 x 0.5

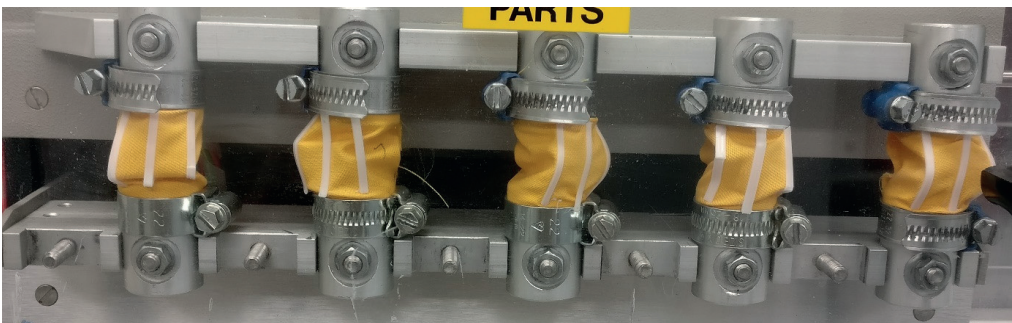
### **6.2.2. Flexing test**

Dynamic-flex fatigue performance of 3D printed samples on fabric is one of the parameters in the measurement of product quality. The revised edition of ISO 7854 (Rubber or plastic coated fabric- determination of resistance to damage by flexing) [109] standard is followed in this test method. Through this flex testing standard, some useful declaration about flexing resistance has been found from PLA filament coated fabrics. Among the three methods, which are described in the standard, Schildknecht method, was found most useful because it is appropriate for relatively lightweight construction and the medium range of usage in terms of flexing.

Rectangular strip of multiple filaments are 3D printed on fabric to mount it on two opposing cylinders so that it maintains the cylindrical form. One of the cylinders is commuted



along its own axis which makes the printed sample compressed and relaxed repeatedly. The process is continued up to a specific number of times or until the first damage is appeared. In this study, average value of the first break is observed as the parameter. The test machine used in this study is Schildknecht flexmeter which consists of pairs of metal cylinders with specific radius and external diameter. One of the each pairs has the ability to reciprocate motion at  $8,3 \text{ Hz} \pm 0,4 \text{ Hz}$ . Tool clips are kept  $10\text{mm} \pm 1 \text{ mm}$  wide for test sample attachments.



*Figure 6.2. Flexing test of standard PLA*

In the first phase of the test, different shapes of printed normal PLA filament are observed on fabric 1 (30% cotton, 70% PE). Length and width is varied to compare results between the different sizes of test samples. Dimensions of the samples are considered in this phase of the test are Length: 30mm, Width: 1.5, 2.0, 2.5, 3.0 mm, Thickness: 0,6-0,7-0,8 mm within dry and vertical as test conditions. Flexing resistance of Three different PLA filament (Normal PLA, copper filled PLA, Graphene filled PLA) printed on two types of fabrics are measured in this section. Average value of same dimensional samples are tested in this phase. All the test samples are seemed to act differently for Fabric 1 (30% cotton, 70% PE), and Fabric 2 (50% cotton, 50%PA). For dry and vertical test conditions the average cycle of first break on F1 and F2 are observed for 30mm x 2,5mm x 0,7mm sized 3D printed samples.

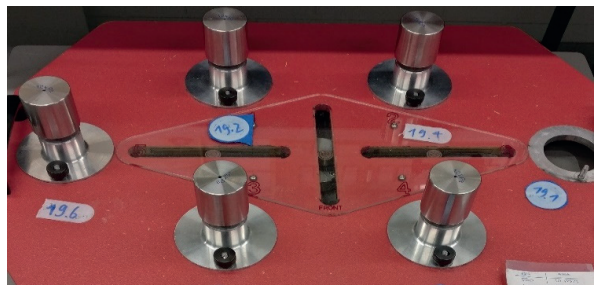
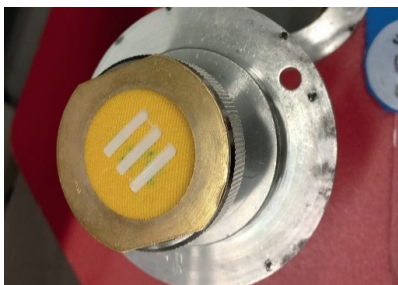
### **6.2.3. Abrasion resistance test**

This test is done according to the standard ISO 12947-2 [12]. According to the standard, test specimen of a circular shape is mounted in a holder which is supported within a load to rub against an abrasive surface. A predefined movement is traced around its own axis and rotates freely perpendicular to the surface of the sample. The abrasion resistance of printed samples

are evaluated within inspection interval to breakdown period. Test samples are mounted on sample holders using foam backing. Samples used in this test are with a mass per unit area more than 500 g/m<sup>2</sup> mounted on sample holders without foam. Among the two abrasion load parameters mentioned in the standard, 795 ± 7 gm is used in this test for technical use with nominal pressure 12 kPa. It continued until the crackdown of the test specimen. The examined period is specified by the interval between initial levels to breakdown point. Number of rubbing cycles are recorded at which samples breakdown occurs. For work wear fabrics, number of rubs are selected according to relevant test intervals specified in table1 for abrasion testing in the standard. Abrasion tester started and continued to the test without any interruptions until it reached the predefined number of rubs in the test machine. After each interval, the samples are removed from the holder to check if there is any breakdown. Process is repeated and samples are placed back on the holder without damaging the threads if no breakdown occurred within the samples. The experiment in this work is divided into two segments. Short description of two setups are:

1) Standard PLA no Fabric 1 (30% cotton, 70% PE) with different width and thickness for dry and after wash condition;

Dimensions	Condition	Observations
	Dry and one time washing sample	
Length: 15mm	Force: 12kPa	
Thickness: 0,6-0,7-0,8mm	Abradant: sand paper 1600 (change	2 or more threads breakdown
Width: 2-2,5mm	after 15000 rubs)	
	Interval: 2000 (40minutes)	



2) Comparison of abrasion resistance between Normal PLA, Graphene PLA, Copper PLA 3D printed on fabric 1(30% cotton, 70% PE) and fabric 2(50% cotton, 50%PA) for both dry and washed conditions.

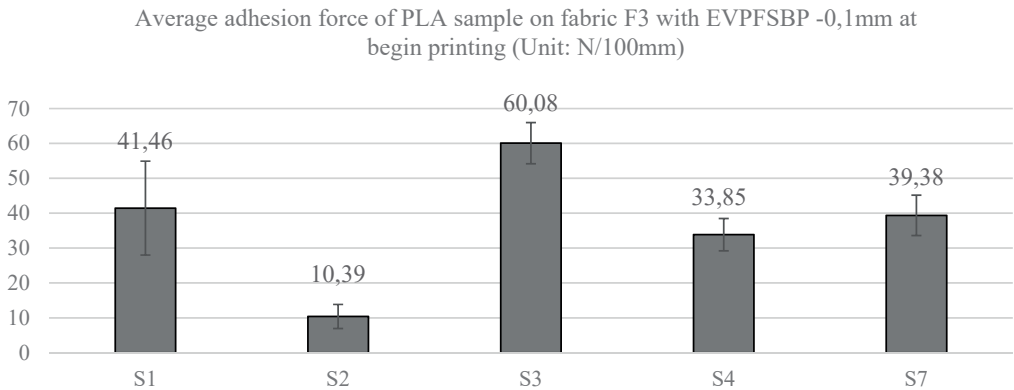
Dimensions	Condition	Observations
Length: 15mm Width: 3mm Thickness: 0,7mm	Dry and one time washing sample	
	Force: 12kPa	
	Abradant: sand paper 1600 (change after 15000 rubs)	2 or more threads breakdown
	Interval: 2000 (40minutes)	

### 6.3. Test results and discussions

#### 6.3.1. Peeling test results

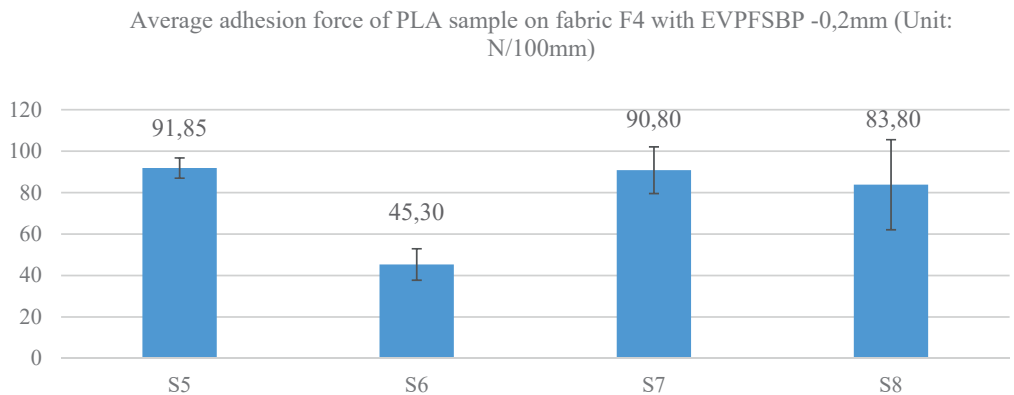
Peeling test is operated according to ISO standard. Angle of T peeling form, and elongation of sample (TPU) are disregarded and results are presented as mean value of adhesion force for each combination with error as standard deviation of 3 samples. Table shows the parameters of each printing method for phase 1. For fabric F3, sample S3 showed the best adhesion force (Figure 6.3.). Figure 6.4. shows sample S5 and S7 which has the best adhesion on fabric F4, and results of S5 and S7 are relatively equivalent. Therefore, S7 or S5 can be chosen to compare with S3 on the same fabric.

Method of sample 7 is chosen as the best method on fabric F4 and printed on fabric F3. Figure 6.3. shows that S3 has more adhesion force than S7. Therefore, the best parameters for printing PLA on fabric are combination of T2 (210°C), L1 (0.05mm), H1 (-0.1mm). From Fig. 6.3 and 6.4., the lower layer height is the factor for better adhesion force. This can be explained that lower layer height gives higher diffusion of PLA on fabric, and this parameter can be adjusted by decreasing first layer height of printing.



*Figure 6.3. Average adhesion force of PLA sample on fabric F3 with vertical position of extruder on fabric surface -0,1mm at begin printing (Unit: N/100mm)*

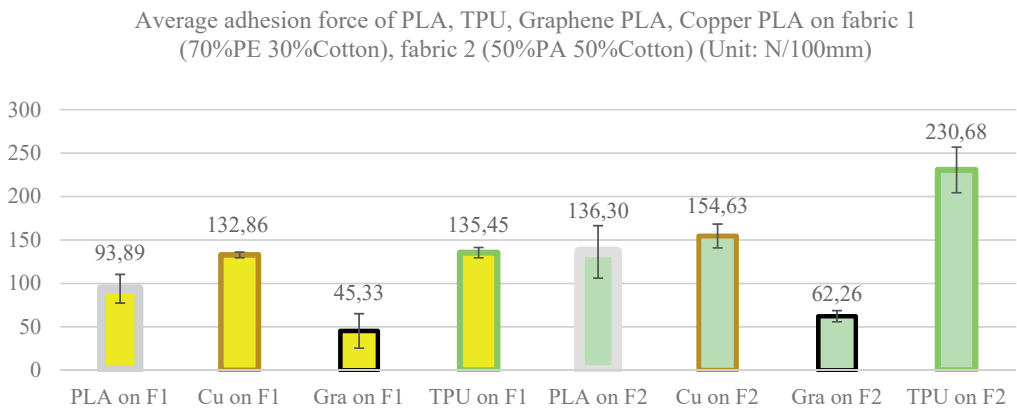
In phase 1, the EVPFSBP -0,2mm shows less adhesion force (Fig.6.4). The filament extrusion is limited when nozzle is attached too deep in fabric, leading to less diffusion of filament on fabric. The higher extruder temperature gave more adhesion force (S3 > S1, S4 > S2, S8 > S6), due to lower density and expanding of filament showed better diffusion of filament to textile.



*Figure 6.4. Average adhesion force of PLA sample on fabric F4 with vertical position of extruder on fabric surface -0,2mm at begin printing (Unit: N/100mm)*

Figure 6.5. shows the adhesion force of 8 combinations of testing method in phase 2. Fabric F2 material is 50% PA, 50% cotton, which has lower percentage of polymer but the result shows better adhesion strength on all filaments. Fabric 1 material is 70% PE, 30% cotton,

which has higher percentage of polymer (70% PE, 30% cotton), but has lower adhesion on all filaments. From practical observation, textile structure has significant effect on adhesion of filaments. From experiments, Printed TPU filament on fabric 2 showed the best adhesion (230,68N/100mm), while Graphene PLA showed the least adhesion force on both fabrics [108].



*Figure 6.5. Average adhesion force of PLA, TPU, Graphene PLA, and Copper PLA on fabric 1 (70%PE, 30% Cotton), fabric 2(50%PA, 50% Cotton) (Unit: N/100mm)*

### 6.3.2. Flexing test results

The first part of this experiment is to determine the best flexing resistance for PLA from different shapes of printed samples. Thickness and width is varied to check the best dimension for flexing test on fabric 1 (70%PE, 30% cotton). The sample length (30mm) is kept constant for this part. Flexing cycle of four different widths (1.5mm, 2.0mm, 2.5mm, and 3.0mm) and three different thicknesses (0.6mm, 0.7mm, 0.8mm) are examined in vertical and dry specimen condition through the Schildknecht flex tester.

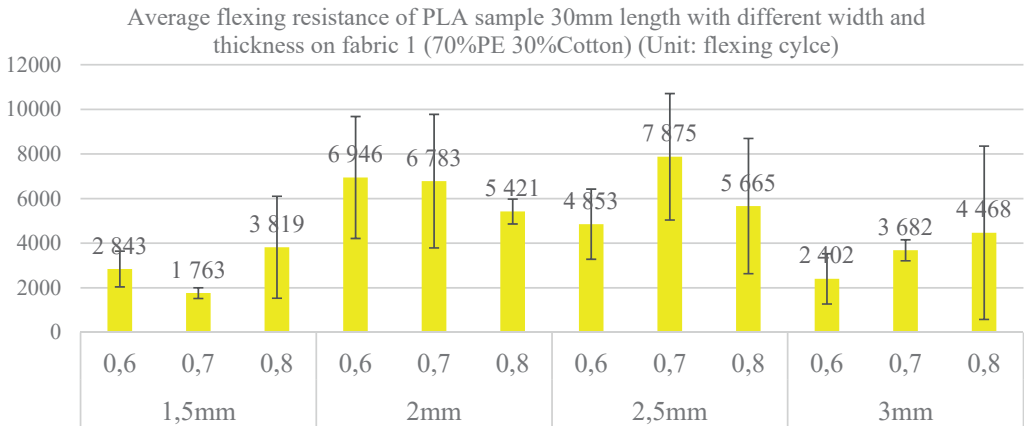


Figure 6.6. Average flexing resistance of PLA sample

Figure shows the average cycle of 1st break through tolerant of PLA sample 30mm length with different width and thickness on fabric 1. The result shows that shape of width 2.5mm and 0.7 thickness gives the best flexing resistance for PLA on F1. This result is applied for Graphene PLA and Copper PLA on flexing resistance test.

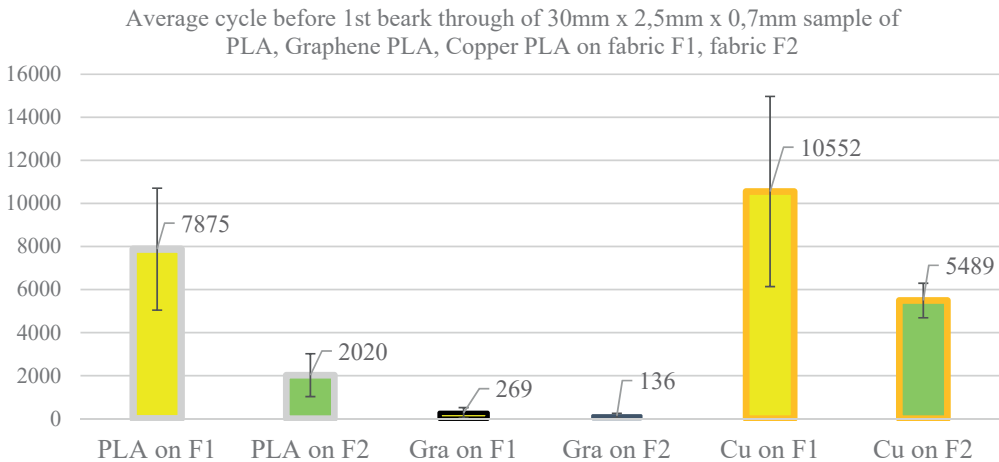


Figure 6.7. Flexing resistance results of PLA, Graphene PLA (Gra), Copper PLA (Cu) on each fabric F1, F2 (cycles).

Flexing resistance of PLA, Graphene PLA, Copper PLA is presented in Fig.6.7. Flexing resistance of samples are depended on its fabric skrinkage and printing material. On both fabrics, flexing resistance has shown descending order from Copper PLA, non filled PLA to

Graphene PLA. Graphene PLA is hard material but non-flexible and crusty depends on its composition with PLA polymer. Copper PLA has great flexibility, which has highest flexing resistance (Fig.6.7.). However, textile shrinkage has great impact on flexing resistance of samples. From measurement results, it seems that fabric F2 (50%PA 50%Cotton) gets more crinkled than fabric F1 (70%PES,30% cotton), therefore, flexing resistance of PLA and Copper PLA drop accordingly by 74.4% and 48% when it is tested on fabric F2.

### 6.3.3. Abrasion resistance test results

The abrasion resistance test is processed according to ISO standard 12947-2:2016 using Martindale 2000 abrasion tester machine (Textiles - Determination of the abrasion resistance of fabrics by the Martindale method - Part 2: Determination of specimen breakdown) [12]. Printing sample for each filament and fabric is planned according to Table 6.4.

Table 6.4.

Printing sample plan for abrasion resistance test

Material	Fabric	Code	Amount of sample	
			Washed	Dry
Fabric 1		PF1	3	3
Fabric 2		PF2	3	3
PLA	F2	S27	3	3
Graphene PLA	F1	S37	3	3
	F2	S43	3	3
Copper PLA	F1	S45	3	3
	F2	S47	3	3

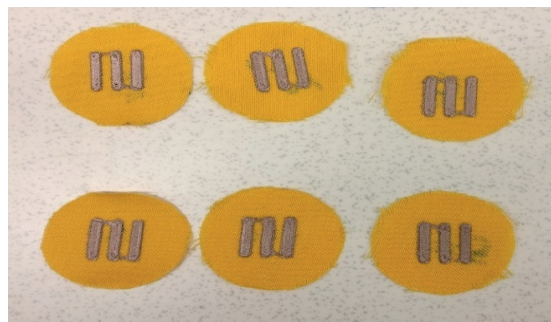


Figure 6.8. Cut sample of copper PLA on fabric F1, each sample have diameter of 30mm.

Fabric with printed sample or non printed fabric is cut by cutter with 30mm diameter (Fig.6.8.). 3 samples are washed according to ISO standard 15797 [110] for color fabric by using Gyrowasher tester. Samples are washed at 75 °C with 31 balls as washing weight for 20 minutes. Washed specimen is rinsed and it is left to dry more than 12 hours at room temperature. Three unwashed specimen and three washed specimen of same printing are mounted to specimen holder with foam underneath. Foam is cut by cutter with 30mm diameter and replaced after every test. Abradant for testing is sand paper 1600 grits, which is cut by cutter with 140mm diameter. Then abradant is mounted to abradant holder with foam underneath (Fig.6.9.). This foam is replaced after each test for each new specimen (ISO 15797 – Part 2 [110]).



*Figure 6.9. Sandpaper 1600 grits are mounted to abradant holder with foam underneath*

The test samples are dried at room temperature under 12kPa force created by weight (Fig.6.11.). The test is stopped in every 2000 rubs (one interval), specimen is carefully removed and checked. Vacuum cleaner is used for cleaning specimen surface and abradant surface gently before checking. Fig.6.10. shows the abradant surface after cleaning. Then specimen is placed again and tested. Abradant is replaced in every 15000 rubs or at the beginning of test of each specimen. (ISO 15797 - Part 2 [110]).



*Figure 6.10. Abradant is cleaned by vacuum cleaner after each intervals (2000rubs)*





*Figure 6.11. Martindale test machine with 6 specimens with pressure of 12kPa*

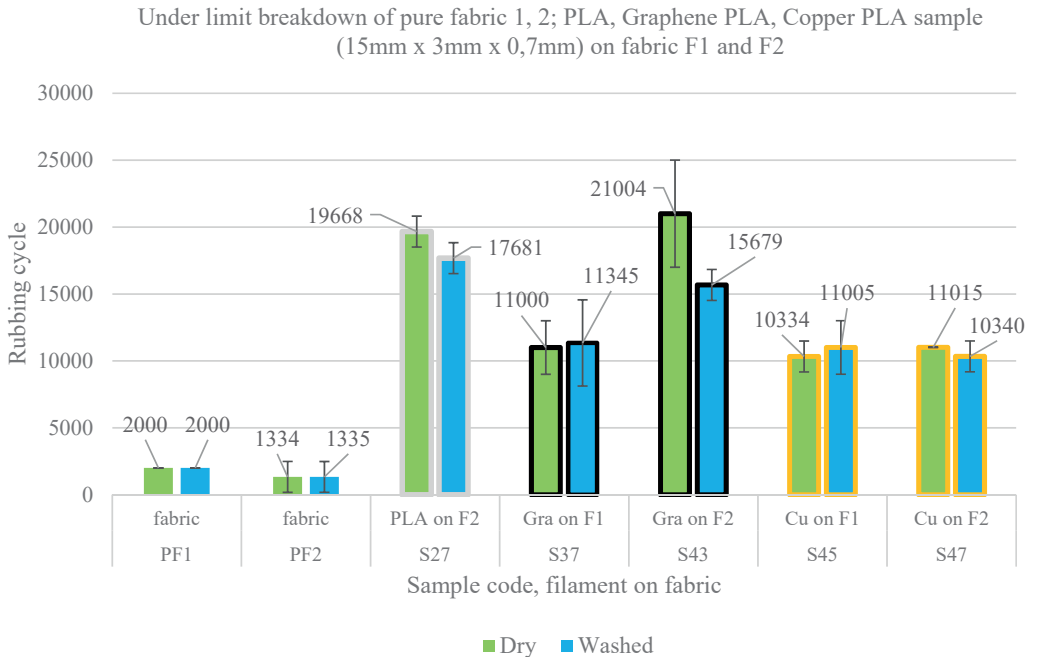
The test ends when two or more threads of specimen are broken, which defines as specimen breakdown (Fig.6.12.). Number of rubs at breakdown is recorded and the collected data is analysed and presented by mean value and standard derivation of error. For example, Figure below shows specimen of printed copper PLA on fabric F1 where breakdown occurred after 13000 rubs; therefore, abrasion resistance of this specimen is more than 11000 rubs (ISO 15797 - Part 2 [110]).



*Figure 6.12. Initial specimen and after breakdown specimen (after 13000 rubs) of cooper PLA sample on fabric F1*

Abrasion resistance of plain fabrics and printed fabrics are shown in Fig.6.13. Under industrial working condition, plain fabrics (PF2) showed significant lower abrasion resistance compare to printed fabrics (PF1). Abrasion resistance of samples depends on hardness of printing material. Therefore, abrasion resistance is ascending from Copper PLA, PLA,

Graphene PLA accordingly (Fig.6.13.). In most cases, no significant differences were found in abrasion resistance of washed and unwashed sample.



*Figure 6.13. Abrasion resistance of plain fabrics (F1, F2) and printed fabric*

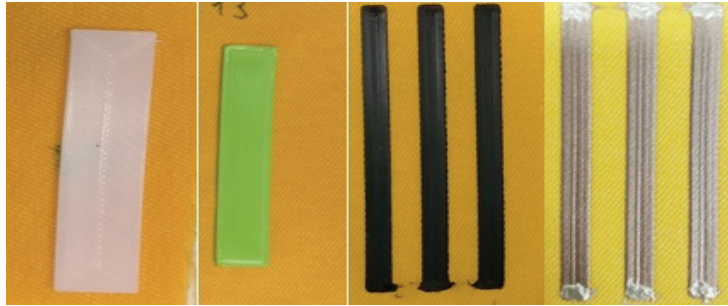
### 6.3.4. Washing test results

Washing test is one the most important parts of this work, in which samples are washed according to ISO standard 15797 (Textiles - Industrial washing and finishing procedures for testing of workwear [110]). Washing test is processed at 40°C and 75°C for each sample. Washing tests are operated in two phases. In First phase, printed samples with conductive filaments are tested on both fabric F1, F2, washing was done three times for each sample. In Second phase, printed samples with non-conductive filaments (TPU, PLA) are tested on both fabric F1, F2, washing was done 10 times in this case. Each test had at least three samples (Fig.6.14.). Test procedures for washing 3D printed samples are shown in the Table 6.5. below.

Table 6.5.

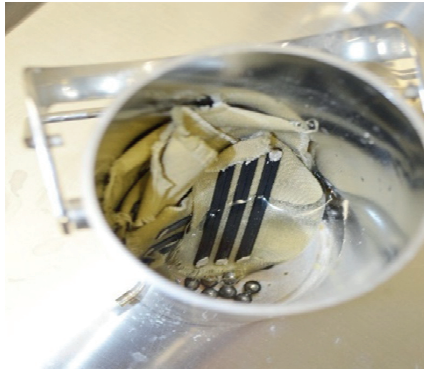
### Test procedures for washing

Filament	Washing test sample size (mm)	Washing time	Fabric	Amount of sample washing at 40 °C	Amount of sample washing at 75 °C
PLA	50 x 10 x 1	10	F1	3	3
			F2	3	3
TPU	50 x 10 x 1	10	F1	3	3
			F2	3	3
Graphene PLA	60 x 4 x (0.2-0.4-0.6-0.8-1)	3	F1	-	5
			F2	-	5
Copper PLA	60 x 4 x (0.2-0.4-0.6-0.8-1)	3	F1	-	5
			F2	-	5



*Figure 6.14. Samples of printed PLA on F1 (left) and samples of printed graphene PLA on F1 (right)*

Washing machine is filled with water first and then heated up to required temperature. Each washing samples are put into 500ml washing vessels with 120ml water, 0.6g detergent and 31 steel balls in it as washing weight (Fig.6.15). The vessels are closed and put into hot water in washing machine for 3-5 minutes, then it is opened and closed again to eliminate increased pressure during heat exchange. Next, washing vessels are installed and locked into rolling shaft (Fig.6.15.). The washing started upon reaching desired temperature level. The time for washing was 20 minutes for each cycle.



*Figure 15. Samples of printed graphene PLA on fabric F2 in washing vessel*

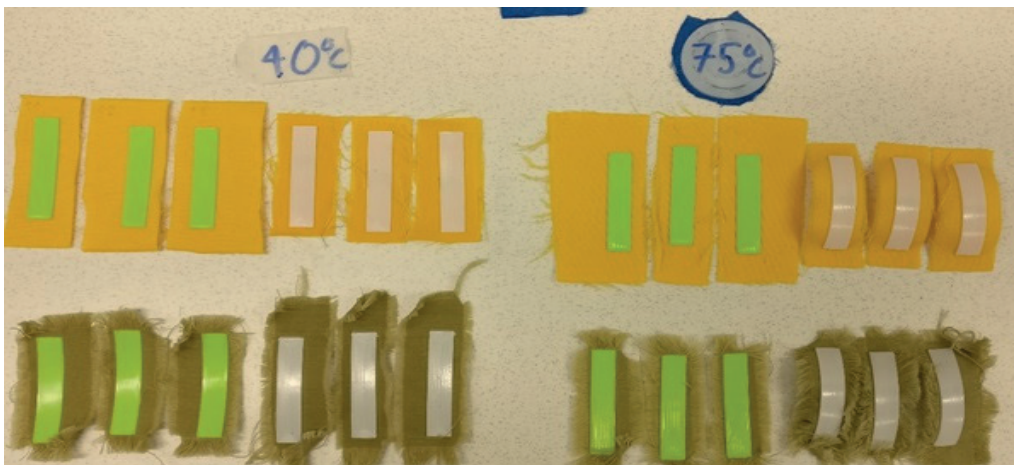
After washing, samples are allowed to cool down for 3-5 minutes by adding water on top. Cooling restricted temperature to drop less than 3 Celcius degree per minute. Then water at room temperature is used for rinsing 3 times. Finally, samples are left to dry at room temperature for at least 12 hours. Washed samples are checked if it is bending and then picture is taken before the next washing cycle. Picture of samples are summerized and compared below.

Copper PLA is totally deformed after 1<sup>st</sup> washing at 75°C, therefore, the test is stopped (Fig.6.16.) in this temperature. Graphene PLA is slightly deformed after 2 times washing. Though Copper PLA has more electrical conductivity than Graphene PLA, but copper PLA easily deformed at high temperature (75°C). Therefore, Copper PLA is not suitable for industrial washing, but 3D printed Graphene PLA showed more thermal stability. Different thickness of samples showed no significant diffrences on washing ability (Fig.6.16, 6.17.).



*Figure 6.16. Washed 2 times Graphene PLA on fabric F1, F2 at 75 °C*

Material and shrinkage of fabrics showed great impact in washing test of PLA. This non-conductive filament showed good wash abilities though it deformed slightly after washing 10 times at 40°C. TPU is elastic polymer and has high glass transition temperature, therefore, TPU recovered normally after washing at 75 °C. TPU only deformed mildly after washing 10 times at 75 °C (Fig.6.17). Meanwhile PLA has lower glass transition temperature, and it bent significantly after washing 10 times at 75 °C (Fig.6.17.).



*Figure 6.17. All samples after 10 times washing: washing sample at 40 °C in the left, at 75 °C in the right*

The figure above shows all the samples washed 10 times at 40 °C and 75 °C. Slight deformation of TPU was shown only on F2 at 40 °C and 75 °C which was visible due to shrinkage of fabric F2, on the other hand, TPU on F1 at both temperatures (Fig.6.17.) was unchanged. So, deformation of printed samples occurred due to the fabric material in this case. PLA bent slightly on F1, F2 at 40 °C, this bending is formed when the surface attached to fabric of PLA sample cools slower than the other surface during cooling process after washing. This effect is more visible at 75 °C (Fig.6.17.).

### **6.3.5. Surface roughness test results**

Surface roughness is defined as the shorter frequency of a surface. It is essential for determining surface topography which is an important factor to confirm its suitability for any function. 3D printed samples are not smooth and different material has different types of printed

surface. Their surfaces involve a complex shape which is made of peaks and troughs with varying heights, depths and spacing. Here, Surface roughness measurement counted each of them and represented data of every individual 3D printed materials. Differences in measurement result surely makes a visual difference [111]. But beside that there are some other facts related to material performance especially for conductive copper filled PLA filament. Surface roughness is one of the important factors that decides conductivity for this material.

The experiment was done using a universal surface measurement instrument which can be used for fast measuring of any type of surface. Using its expansive range of sensors made it possible to do the measurement task for printed conductive copper and nonconductive standard PLA samples. In this process, the used measurement device is combined with integrated CCD camera with illumination, energy efficient LED, CWL technology, motorized sensors etc. Measurement is controlled by computer with TFT monitor. This multi sensor measuring system is customizable and flexibly adjustable by simply changing the sensor [111]. It can be used in chromatic distance measurement technique. LED is the white light source here, from there white light is generated and focused on the sample surface through measuring head with strong wavelength dependent focal length. Peak is generated in the spectrometer by the light reflected from spectrum. This peak is used to determine the heights of the experimental object. The measurement set up has the ability to observe highly reflective, transparent and also light absorbing materials [111].

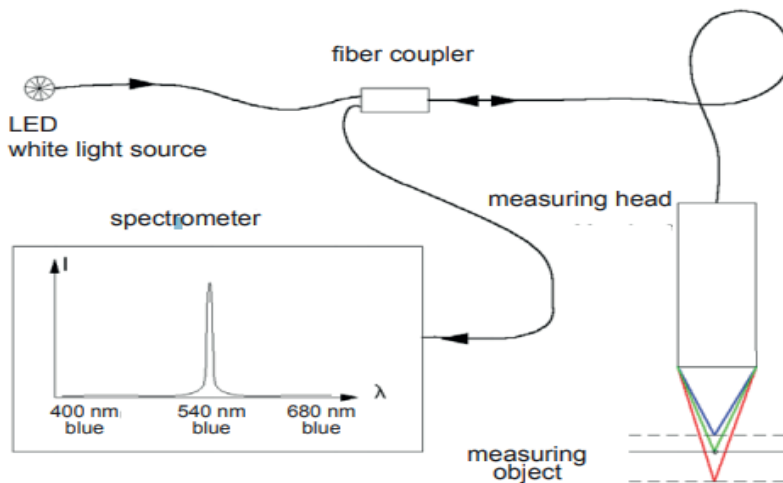


Figure 6.18. Surface roughness measurement set up

Table 6.6.

### Surface parameters of Copper filled and standard PLA

#### Surface parameters of Copper filled PLA

according to ISO 4287:  
 $L_s = 0.000 \mu\text{m}$ ,  $L_c = 0.795 \text{ mm}$   
 $x = [0.000 \text{ mm}, 3.986 \text{ mm}]$

Ra: 14.715  $\mu\text{m}$   
Rq: 20.944  $\mu\text{m}$   
Rz(ISO): 77.328  $\mu\text{m}$   
Rz(DIN): 74.142  $\mu\text{m}$   
Rmax: 85.818  $\mu\text{m}$   
Rp: 23.270  $\mu\text{m}$   
Rv: 66.149  $\mu\text{m}$   
Rt: 89.419  $\mu\text{m}$   
Rsk: -1.789  
Rku: 4.955  
RPc: 20.068 /cm

#### Surface parameters of standard PLA

according to ISO 4287:  
 $L_s = 0.000 \mu\text{m}$ ,  $L_c = 0.791 \text{ mm}$   
 $x = [0.000 \text{ mm}, 3.963 \text{ mm}]$

Ra: 8.492  $\mu\text{m}$   
Rq: 10.098  $\mu\text{m}$   
Rz(ISO): 33.912  $\mu\text{m}$   
Rz(DIN): 34.852  $\mu\text{m}$   
Rmax: 39.796  $\mu\text{m}$   
Rp: 21.688  $\mu\text{m}$   
Rv: 20.489  $\mu\text{m}$   
Rt: 42.177  $\mu\text{m}$   
Rsk: 0.000  
Rku: 2.118  
RPc: 25.230 /cm  
Rk: 28.808  $\mu\text{m}$

In this phase of work, samples were 3D printed with two different materials using same parameters and textile platform. These two tables shows the surface parameters for those two materials. Surface roughness is also known as surface profile (Ra). It is a measurement of surface finish. It is a quantitive calculation of an area which can be expressed as a numeric parameter (Ra). It can be extracted as a line through an area. Like Ra, RMS (root mean square) is another term which represents the surface roughness. It can be calculated differently [111]. In this work profile roughness was was calculated as the the term, Ra which is the arithmetic average of of the absolute values. The values were taken from profile height deviations from mean line within evaluation length. The other terms in the measuremnt charts are the sets of individual measuremnts of peaks and valleys from the same surface. The peaks and valleys were taken from microscopic surface texture (Fig.6.19.). After calculating all the values into formula, mean arithmetic roughness (Ra) was calculated and expressed in micrometers. For 3D printed copper filled PLA, Ra was found 14.715  $\mu\text{m}$  and on the other hand, standard PLA showed much lower surface roughness  $Ra = 8.492 \mu\text{m}$  in this measurement. Figure below shows the microscopic images (2D and 3D scanned) and surface profile graph from measurements.

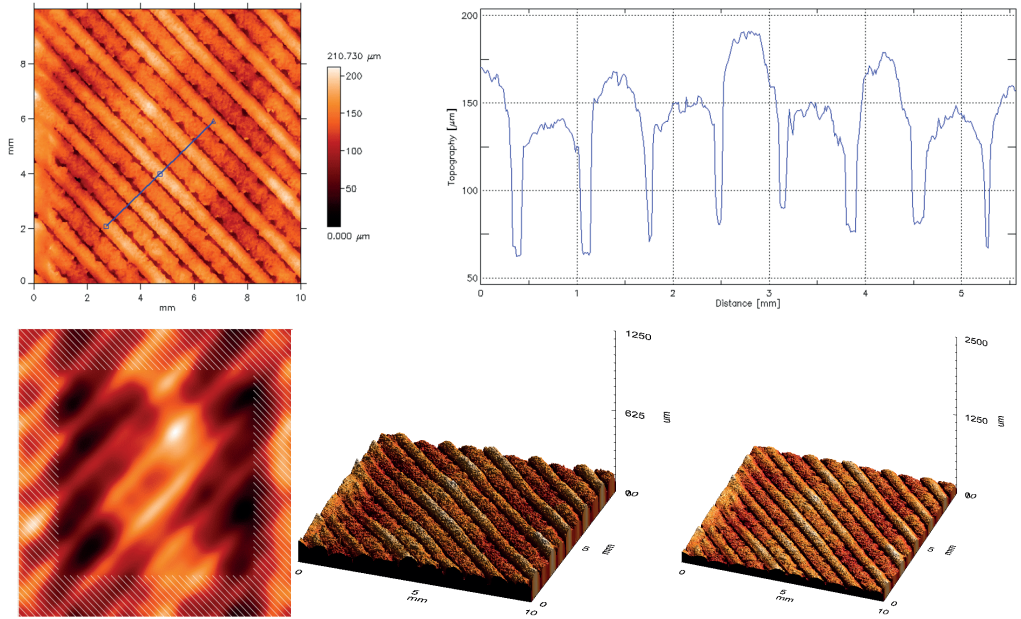


Figure 6.19. Analysis of 3D microscopic image (Copper filled PLA)

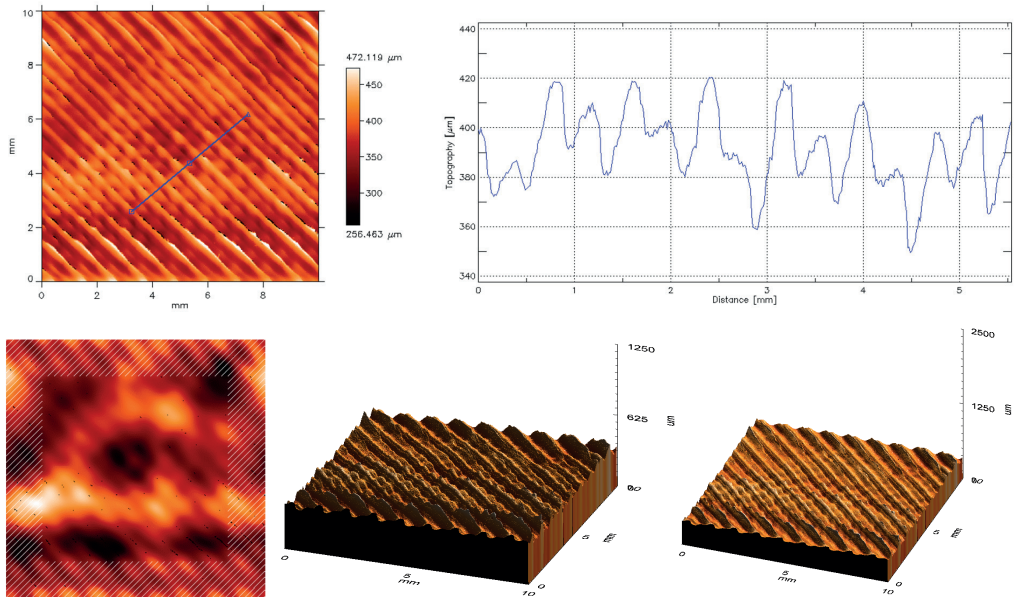


Figure 6.20. Analysis of 3D microscopic image (standard PLA)



### 6.3.6. Water absorption test results

As washable electronics integration is a part of the work, 3D printing of thermoplastic polyurethane (TPU) filament was considered as the encapsulation material. Because of its flexibility, mechanical stability, temperature resistivity and good adhesion to fabric this material was tested as a part of water resistive electronic system for smart work wear. The water absorption testing of 3D printed TPU was observed according to ISO 62:2008 (“Plastics. Determination of water absorption”) standard. This international standard determines the moisture absorption through the thickness direction of a flat or curved surface of solid plastics for a specific time period. It can be used to make comparison between different batches of the same material. It also defines the resistivity of water when immersed into it or subjected to controlled humid air condition [112].

In this work, test specimens were 3D printed on fabric (50% Polyamide, 50% cotton) and glass substrate. The rectangular shaped specimens were 1.5cm in width and 9.5cm in length and 1.2 mm in thickness. Samples were divided into four parts for comparing between different cases and for providing a clear conclusion. But, all the samples were designed in same dimensions. Those are:

- 3D printed samples on fabric (50% Polyamide, 50% cotton)
- 3D printed ( using TPU) sample Peeled from fabric
- 3D printed samples on glass substrate
- Only fabric (50% Polyamide, 50% cotton)

For this experiment, RFID was encapsulated through 3D printing technology using TPU filament on fabric and glass. The total thickness of the designed specimens were 1.2 mm, with 0.2 mm gap for inserting the electronics part. The process was done by overprinting and bridging technique using 3D printing technology. Then, test specimens were immersed into distilled water at 23°C. All the samples were placed in the same container with at least 300 ml per test specimen. Those were carefully inserted so that there was no contact between specimen and container [112]. As printed TPU has lower density than water, samples were connected with stainless steel holder for immersing it under water. The amount of water absorption were measured (in milligram) by taking difference initial mass of the specimen and the mass after exposing in water. Time interval between each measurements were 6 h, 12 h, 24 h, 48 h, 96 h, 192 h, 384 h, 768 h, 1536 h. In each of them test specimens were removed from the container and weight was taken immediately in weight scale just after cleaning the surface water

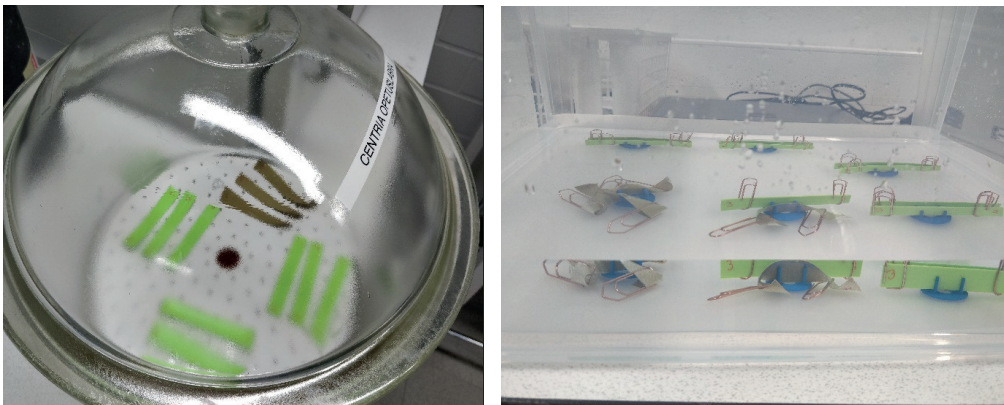
with dry cloth. Mass difference was taken between before and after water immersion within some specific time period (mentioned above). The final result of water absorption (amount of water added) is expressed in percentage [112].

Formula for calculating percentage of water absorption by mass:

$$C = ((m_2 - m_1) / m_1) * 100\%$$

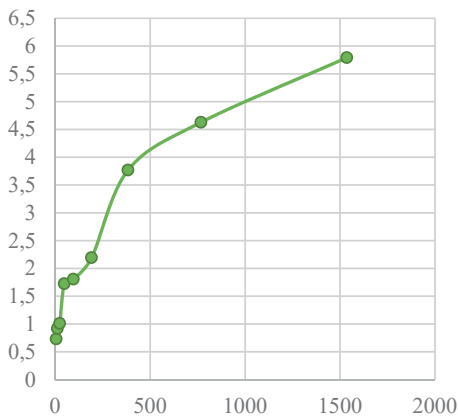
$m_2$  = Mass of specimen (in mg) after initial drying and before immersion

$m_1$  = Mass of specimen (in mg) after immersion

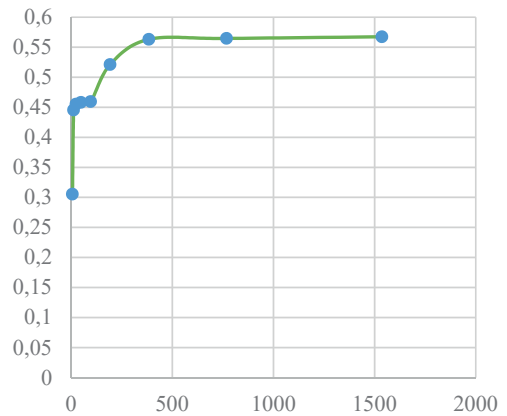


*Figure 6.21. Water absorption testing of 3D printed samples*

Graph 1: Sample 3D printed on fabric, Hours vs Percentage of water absorption

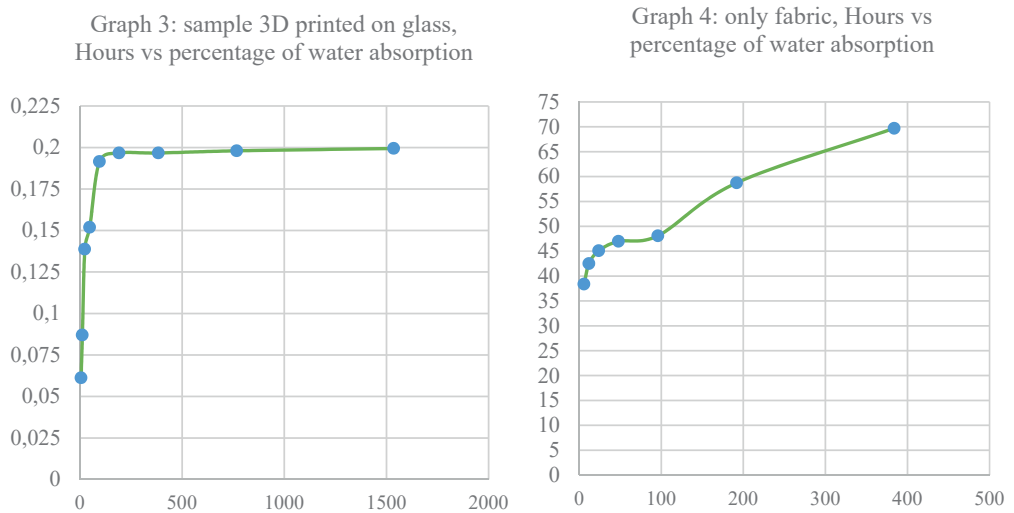


Graph 2: Sample 3D printed and peeled from fabric, Hours vs percentage of water absorption



*Figure 6.22. Hours vs percentage graph for 3D printed samples on fabric*

Fig.6.22., 6.23. shows the percentage of water absorbed by 1.2mm thick 3D printed TPU layer in different immersion period for four different types of samples. Here, Graph 1 is the test specimen of 3D printed TPU on fabric. In this case, highest percentage (5.79%) of water was absorbed by the sample due to the fabric which absorbed almost all the water inside. It showed large difference in getting the real amount of water absorbed by the materials. The experiment was observed up to 1536 hours and curve has continued to increase up to 5.79%. Because of the attachment with fabric, it didn't meet saturation point and the percentage of water absorption about to follow the increasing trend up to indefinite time period. In the second phase, the specimen was printed on fabric and peeled from there for observing the influence fabric in water absorption. The water absorption was found maximum 0.56% and it started saturating after 384 hours. Then, it reached the saturation point and continued the same value up to 1536 hours. As it was peeled from, fabric there were some very little part of fabric still found in microscopic image before immersing into water.



*Figure 6.23. Hours vs percentage graph for 3D printed samples on fabric.*

The effect of fabric attachment with sample became clearer in sample 3 (Graph 3). Here, TPU filament was 3D printed only on glass substrate. As it was only TPU encapsulated with electronics on glass, the water absorption of fabric was not included and the curve saturated when it reached minimum 0.2% water absorption. Then, Graph 4 shows a clear view that how fabric itself absorbed water in a regular basis. There, it followed an increased trend up to infinite

time period. So, there were some unwanted effect found on testing water absorption of material when the fabric was included with the result along with the encapsulated material. But, the TPU printed material which the main protective part of the electronics system showed satisfactory result for Sample 2 (0.56%) and Sample 3 (0.2%) in this experiment. So, flexible TPU, the 3D printed material itself showed low water absorption percentage in the testing and was able to fulfill electronics encapsulation system requirements.

### **6.3.7. Discussions**

This report has shown results of 3D printed filaments on fabric and adhesion properties of PLA, TPU, Copper PLA, and Graphene PLA on fabric F1 (70%PE, 30% Cotton), F2 (50%PA, 50% Cotton). Also, some significant results were also found from flexing resistance, abrasion resistance and washing ability of different printing filaments on two work wear fabrics. The important parameters of printing on fabric is printing speed, extruder temperature, and layer height and extruder vertical position. Peeling test was completed according to ISO 11339:2010 standard. The result showed that, adhesion force ascending from graphene PLA, PLA and copper PLA, TPU on both fabric F1, F2. The three other tests are also processed according to ISO standards. The crucial factor is printing material in term of flexibility, elasticity, hardness and glass transition temperature. Furthermore, fabric material significantly effects the test result for their shrinking properties.

From the experiments, flexing resistance is ascending from Graphene PLA, Standard PLA, and Copper PLA on both fabrics. Flexing resistance of samples are lower on fabric with more shrinkage (F2). Abrasion resistance is ascending from Copper PLA, Standard PLA, and Graphene PLA on both fabrics. Abrasion resistance of plain fabric is lower than printed fabric. Experiment of conductive filament under industrial washing conditions showed that Copper PLA has deformed slightly compare to Graphene PLA which didn't change the shape at all. On the other hand, tests of non-conductive sample under industrial washing condition showed that PLA is bending significantly at elevated temperature 75°C, while TPU has recovered after washing. TPU is suitable for industrial washing. After washing at 40°C, non-conductive material sample had no significant changes. Shrinkage of fabric affected the deformation of sample during cooling process.

From results of this report, PLA, TPU and Copper PLA has shown good printing ability on fabric with good adhesion. Copper PLA is conductive filament, which can be used in printing electronic circuits and RFID antenna on fabric. Bioplastics PLA with hard properties and

flexible TPU can be used to print the encapsulation part of sensors or chip on fabric. Better adhesion results of printed filaments were found on fabric 2 (50%PA, 50% Cotton), which can be used for army uniforms. It opens application of 3D printed IoT in military work wear. However, work wear fabric F1 also can be applied this 3D printing technology for workers environmental safety monitoring system.

This study is based on adhesion of filaments that is needed for further research on properties of printed samples on textile such as flexible resistance, abrasion resistance and washing test. Beside these, water absorption tests and surface roughness parameters were also presented in this work. Results can be useful for different electronics application of chips or sensors and for improving encapsulation method of electronic devices such as circuit connections, battery, and battery charger etc. Analysis of those results has clarified that the 3D printed material that was tested can also be used for washable, waster resistance and for other purpose in integrating electronic circuits.

## **7. TO ENHANCE SAFETY AND WELLBEING OF FIREFIGHTER BY INCORPORATING ADVANCED WEARABLE ELECTRONICS INTO CHEMICAL PROTECTIVE CLOTHING CPC**

### **7.1.Introduction**

Safe protective clothing now composes significant part of technical and industrial textiles due to different and specialized hazards to which workers in various activities and industries are exposed. Thus, different is worn for self-protection, civilian jobs, military purposes, terrorism attacks and biochemical accidents. Concerning chemical protective clothing (CPC), it is classified into types from 1 to 7, related to the nature of exposure: gas-tight, spray-tight, liquid-tight, etc. This classification is based on European standards, which describe testing methods of the whole garment [113]. Firefighters from first response teams usually are mostly exposed to the effect of hazardous substances and require the highest protection provided by type 1 fully encapsulating suits, which often are stiff and bulky. Human performance analysis show that the effect of these suits on wearer's ability to perform various tasks must be investigated as its negative impacts may be: the increase of heat stress, the reduction of task efficiency and of firefighters motion range. Type 1 highest protection CPC are always worn by trained emergency teams members when dealing with high hazardous or unknown substances [114].

Usually first response teams against chemical accident are responsible for: 1) event recognition, 2) incident medical command and control, 3) safety and personal protection, 4) decontamination, 5) isolation of the incident area, 6) sampling and detection, 7) communication and coordination, 8) triage, 9) treatment, 10) transportation, 11) recovery activities, 12) fatality management. Evacuation, i.e. incident site isolation and zone establishment together with triage and transportation is always a priority, because survival depends on the speed. People on one side of clearly demarcated "hot line" are "dirty" (contaminated), and people on the other side are "clean" (Fig. 7.1.). Anyone, entering the "dirty" area must wear appropriate protective equipment and must be decontaminated before coming back to the "clean" area [115].

Chemical protective clothing (CPC) of type 1, which provide maximal protection against vapours and liquids, is usually composed of fully encapsulating chemical-resistant suit, gloves, boots and a pressure-demand self-contained breathing apparatus (SCBA) or a pressure-demand supplied air respirator and escape SCBA. Nowadays different efforts are made to increase the level of thermal comfort in protective clothing, but still there is insufficient investigation efforts

of CPC type 1 suits on task execution and human performance [114]. Bensel, Teixeira and Kaplan (1987) [116] assessed the effect of standard CPC upon different aspects of a wearer's performance: speech intelligibility, visual field, body mobility and psychomotor coordination. Obtained results revealed that complete CPC system restricted visual-motor coordination. Face mask and hood burdened the ability to understand spoken words and to be understood when speaking. In general the impact of the protective clothing on physical mobility and psychomotor coordination varied with the performed work.

Bensel (1997) [117] has also observed that CPC suit imposed thermal as well as mechanical impediment, i.e. not only body movements of wearer are limited, but also it includes wearer's psychological stress the symptoms of which are breathing distress, tremors, and claustrophobia. Respirators restricted the visual field, as well as affected speech intelligibility [117].

The effect of CPC on soldier's performance has been researched by Headley and Hudgens (1997) [118]. They made the conclusion that most military tasks could be performed satisfactorily while wearing CPC, but additional time is required for this. Also found out that higher ambient temperatures and higher workloads negatively impact soldier's endurance [118].

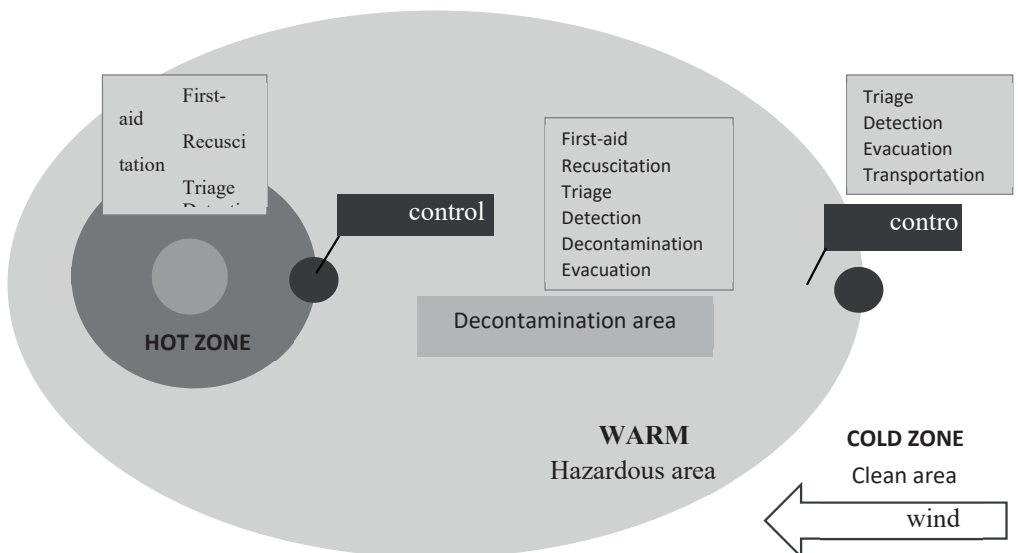


Figure 7.1. Rescue activities in chemical accident area [115]

Krueger (2001) [119] concluded that chemical-biological protective clothing (CBC) imposes significant physiological, psycho-physiological and biomechanical effects on the

performance. The study concluded that bulky protective gear, including gas masks, rubber gloves and over-boots slowed down the performance and required up to 30 percent more time for completing the tasks [119].

Adams et al. (1994) [120] investigated the factors that affect users performance while wearing personal protective equipment (PPE) and developed conceptual model for systematic study of PPE negative effects. New method related four factors (clothing parameters, task requirements, worker characteristics and environmental conditions), which can cause three immediate effects upon worker's performance: 1) reduction in movement speed, range of motion, accuracy and degradation in ability to receive visual and auditory feedback; 2) physiological responses - increased heart rate, blood pressure, oxygen consumption and fatigue; 3) disagreeable sensations - thermal discomfort, localized pressure, chafing and skin wetness. [120].

Belmonte 1998 [121] in his research has shown that the duration for which A level suit provides the user with protection differs based on its design, the degree to which the suit fits the user, the body motions required, and the concentration of the chemical agent present in the environment. The results of other investigations also prove that it is highly unsafe for a person to remain in A level suit beyond 60 minutes and that medical monitoring needs to be conducted and person may be required to remove the suit sooner [121].

Hancock and Vasmatazidis (2002) [122] investigated the effect of heat stress on cognitive performance and stated that decrease in endurance and performance are directly linked to heat stress: 1) heat stress has a differential effect on cognitive performance in respect to the type of task; 2) a relationship can be demonstrated between the effects of heat stress and deep body temperature [122].

In the other works hot and cold temperatures have also been reported to negatively impact performance on a wide range of cognitive related tasks. Hot temperatures of 32.22°C degrees or above were reported to result in a substantial decrease of 14.88 percent in human performance when compared to neutral temperature conditions. Meantime hot exposure at temperatures above 26.67°C degrees caused a negative impact on reaction time [123].



## 7.2. Chemical resistance of protective clothing

Chemical hazard is the most complex of all hazards and it exists in big variety. It is estimated that more than 100 000 chemical products with different toxicological properties exists in the world [124]. Chemical hazards can be experienced in different human activities and related industries, e.g. chemical protective clothing (CPC) of Ansell company from Sweden is developed for chemical, fire and rescue, food processing, industry, law enforcement and life sciences activities where accidental release of toxic gases, biohazard response, chemical leaks, plant emergencies tank cleaning, unexpected leakages spills or other releases are often to appear.

Hazardous chemicals can be defined by different ways. One of them is the level of risk when the amount of chemical, exposure time and toxicity are taken into account. The other method is the classification of chemicals into particles, liquids and gases what requires different strategies for protection. There are four possible interactions between chemical environment and chemical protective textile, and any combination of those four can occur [125].

1. the most common way by which chemicals flow through a protective clothing is through penetration, i.e. through pinholes, stitched seams, between zipper teeth, a tear, a rip or other imperfections of clothing. The simplest way to determine imperfections affecting barrier properties is to inflate the garment with air and to check where the air passes out the garment [126].

2. the other way is degradation, which is the breakdown of clothing material structure and change of its physical properties. Signs of degradation are: discoloration, swelling, occurrence of cracks, hardening and flaking or even decomposition. Increase and decrease in weight along with visual inspection are the simplest ways to determine degradation of a protective material [126].

3. the most research in the world has been reported on the third way – permeation, which is a complex process and described by chemical diffusion through the protective clothing in a molecular level. The stages of the process are: a) absorption of the chemical by the barrier material, b) saturation of the barrier material, c) desorption of the material from the unexposed surface with the increase of chemical concentration. The process is not visible by the naked eye. The chemicals are moving through the material at a speed that is called the permeation rate ( $\mu\text{g}/\text{cm}^2/\text{min}$ ) [126].

4. in the fourth way the chemicals may not interact, but evaporate and the vapor will either go into the atmosphere or enter the garment [125].

### 7.3. Types of protective materials

Various innovative laminated fabrics, composed of multiple barrier layers, are used where protection to chemical, biological heat, flame, etc. risks together with their durability and comfort are needed. Nowadays chemical protective materials can be classified into four types (Fig. 7.2) [125, 127].

1. air-permeable materials usually present the combination of three: first is woven shell fabric, which is not only permeable to air, liquids and aerosols, but also to vapours. The second is the layer of sorptive material, e.g., activated carbon impregnated foam or a carbon-loaded non-woven felt, which is required to absorb toxic chemical vapours, and the third is liner fabric. Functional finishes are usually applied to the outer-shell of such fabrics to provide liquid repellence, as they can easily penetrate materials at low hydrostatic pressures.
2. semipermeable materials are porous (macroporous, microporous and ultraporous) and solution/diffusion membranes. Aerosols, vapours, etc., do not experience any separation when they pass through the large pores of macroporous membranes. Meantime microporous membranes allow lighter molecules to preferentially diffuse through their pores. An ultraporous membrane is also a molecular sieving layer, which excludes larger molecules due to their size. A solution-diffusion membrane is nonporous, where gas dissolves in, diffuses across it, and desorbs on the other side, e.g. Gore-Tex membrane. The whole process is dependent upon gas concentration gradient, time and membrane thickness.
3. impermeable materials were used for a long time, especially where chemical protection is needed. Butyl, halogenated butyl rubber, neoprene and other elastomers provide barrier to penetration of liquid, vapor or aerosol chemical agents, but delay the transmission of moisture from the body to the environment, thus increasing the danger of heat stress in warm and hot climates. Fully encapsulated splash-tight suits (type 1a) are examples of impermeable clothing systems. They present the highest protection against chemical warfare agents, but at the same time they are costly and heavy.
4. selectively permeable materials are thin, lightweight and flexible, and don't need additional layer of sorptive material, because their protection mechanism is based upon a selective solution/diffusion process.

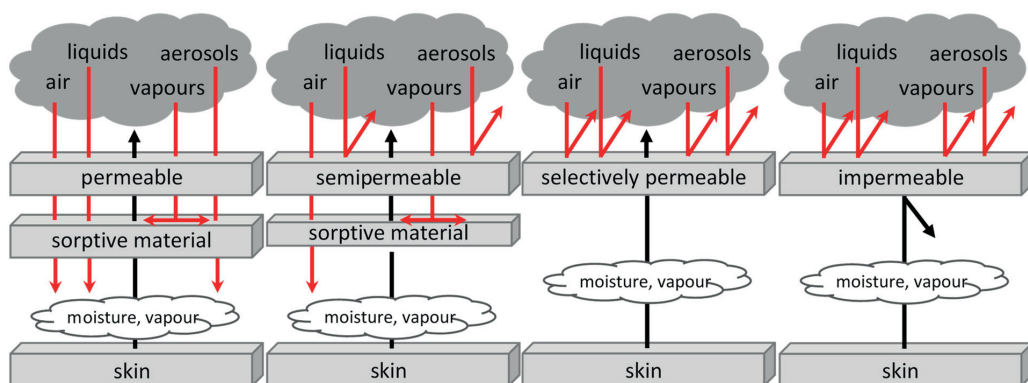


Figure 7.2. Performance of different types of protective materials: permeable, semipermeable, selectively permeable and impermeable [125]

#### 7.4. Requirements for European types of chemical protective clothing (CPC)

The information is provided in Technical report CEN/TR 15149 “Protective clothing – Guidelines for selection, use, care, and maintenance of chemical protective clothing” and standard ISO 16602 “Protective clothing for protection against chemicals – classification, labelling, and performance requirements” [126].

**Type 1** vapor-protective suits against hazardous gases, liquids, aerosols and solid particles are divided into subtypes: 1a with a breathable air supply inside, e.g. self-contained open-circuit compressed air breathing apparatus; 1b with breathable air supply worn outside the CPC; 1c with positive pressure of breathable air provided via air hose. The chemicals may be: dimethyl sulphate, ammonia, chlorine, cyanogen chloride, hydrogen cyanide, sulphur mustard and sarin.

**Type 2** is not gas-tight and positive pressure of breathable air is provided into the suit via air hose. It can be used against aerosols, sprays, or gasses, e.g., in the manufacture of drugs where the task does not require to move around a lot.

**Type 3** has liquid-tight connections between different parts of the suit and is used where the contaminants are not air-borne, chemicals may splash with pressure and the employee has to lean on contaminated surfaces.

**Type 4** has spray-tight connections between different parts of the suit and is used where the contaminants are not air-borne, splashes of chemicals may exist, but the splashes are not pressurized.

**Type 5** is for protection from air-borne solid particle such as asbestos, lead dust, and other hazardous dusts.

**Type 6** is for tasks where limited protection against liquid chemicals is needed [126].

### 7.5. Components of chemical protective clothing (CPC)

The seams are the most vulnerable to leaks and tears in CPC, thus their construction is very important. Different seams may be found on CPC, including folded/lap sealed (by heat), glued, stitched, sewn, or combinations of the above (Fig. 7.3). The simplest is the stitched seam used mostly for type 5 and 6 suits. The bound seam provides better imperviousness, but not equal permeation compared to fabric alone, because needle holes are present. Stitched and over tape seams, as well as welded seams provide equal or better barrier than fabric and are often used for type 1, 2, 3 and 4 CPC suits. Nevertheless, stitched or sewn seams must be avoided for vapor-protective and liquid-splash suits because they are prone to leaking and can weaken the material. The same requirements must be followed by closure systems such as zippers and coverings [128].



Figure 7.3. Seam types in CPC suits: a) stitched seam; b) bound seam; c) stitched and taped seam; d) welded seam [128]

Other components of chemical protective CPC suit are: visors, gloves and boots. Visors are usually made of polyvinyl chloride (PVC), clear polycarbonate, etc. and are permanently attached to the suit by glue or heat welding in order to prevent leakage. As the work in contaminated zone requires direct hand contact with the hazardous materials gloves must also be chemical-resistant and durable. They must not leak and must be of equal or superior quality material as the primary garment. The boots are the part of the suit which usually are in direct

contact with hazardous materials. They must meet and pass the same test criteria as the primary suit material [125].

The use of excellent protective materials, effective closures and ergonomic survival equipment for an individual soldier will be meaningless and unproductive without proper garment designs. Garments are design differently based on the characteristics of the protective materials, different applications and environment to protect and to maximize the time that a user can operate while wearing the protective garment. They are: one-piece garments, two-piece garments, over-garments, under-garments, multilayer garments [129].

## 7.6. Risk codes, phrases and pictograms of CPC

For chemical protective clothing (CPC) the information related to risk codes, phrases and pictograms is of high importance. Risk phrases are defined by “European Commission Directive 2001/59/EC – classification, packaging, and labelling of dangerous substances” [126, 130].

R21	harmful in contact with skin
R24	toxic in contact with skin
R27	very toxic in contact with skin
R34	causes burns
R35	causes severe burns
R38	irritating to skin
R43	may cause sensitization by skin contact
R45	may cause cancer
R46	may cause heritable genetic damage

Risk code	Description of hazard	EU classification abbreviations
Tx	very toxic	T+
T	toxic	T
Cx	highly corrosive, causes severe burns	C
C	corrosive, causes burns	C
X	harmful	Xn
Xi	irritant	Xi



Pictogram *Skin and less serious hazards* refers to harmful in contact with skin and less serious hazards such as skin irritancy/sensitization (risk code Xi and X; risk phrases 21, 38, 43).



Pictogram *Damage to organs* refers to damage to organs and reflects serious longer term health hazards such as carcinogenicity (risk codes Tx and T; risk phrases 45 and 46)



Pictogram *Fatal in contact with skin* refers to fatal in contact with skin (risk codes Tx and T; risk phrases 24, 27)



Pictogram *Skin burns and eye damage* refers to skin burns and eye damage

(risk codes Cx and C; risk phrases 34 and 35)

### 7.7. Fully Encapsulating CPC suit (Ansell company)

The object of investigations was Trelchem®VPS encapsulating CPC clothing (type 1a), which is always used with a self-contained breathing apparatus (SCBA) worn inside the suit (Fig. 7.4). It is made from a polyamide fabric coated with chloroprene rubber on the outside and a polymer barrier laminate on the inside. This CPC suit provides excellent chemical protection for more than 8 hours against a wide range of chemicals, as well as great abrasion and flame resistance (Fig. 7.5). Slightly lower parameters are foreseen for rubber boots, visor and zipper [131].



Figure 7.4. Encapsulating CPC suit and breathing gear worn inside the suit

CHEMICAL	RESISTANCE TO PERMEATION - PERFORMANCE CLASS*			
	EVO suit material	EVO seam	VPS-Flash/ VPS suit material	VPS-Flash/ VPS seam
Acetone	6	6	6	6
Acetonitrile	6	6	6	6
Ammonia (g)	6	6	6	6
Carbon disulphide	6	6	6	6
Chlorine (g)	6	6	6	6
Dichloromethane	6	6	6	6
Diethyl amine	6	6	6	6
Ethyl acetate	6	6	6	6
Heptane	6	6	6	6
Hydrogen chloride (g)	6	6	6	6
Methanol	6	6	6	6
Sodium hydroxide, 40%	6	6	6	6
Sulphuric acid, 96%	6	6	6	6
Tetrahydrofuran	6	6	6	6
Toluene	6	6	6	6

\* For classification, see page 90

COMPONENTS - RESISTANCE TO PERMEATION BY CHEMICALS			
CHEMICAL	NITRILE RUBBER BOOTS	VISOR <sup>1</sup>	TRELLCHEM HCR ZIPPER <sup>2</sup>
Acetone	≥3	6	6
Acetonitrile	≥3	6	6
Ammonia (g)	6	6	6
Carbon disulphide	≥3	6	1
Chlorine (g)	6	6	6
Dichloromethane	2	5	Pass *)
Diethyl amine	5	6	1
Ethyl acetate	5	6	1
Heptane	≥3	6	6
Hydrogen chloride (g)	6	6	6
Methanol	≥3	6	5
Sodium hydroxide, 40%	6	6	6
Sulphuric acid, 96%	6	6	5
Tetrahydrofuran	4	5	1
Toluene	5	6	3

Figure 7.5. The resistance of CPC material, boots, visor and zipper to chemicals

Such type of protective clothing is used in human activities related with: chemicals, fire and rescue, food processing, various industries, law enforcement and life sciences, i.e. the activities which may face: accidental release of toxic gases, biohazard response, CBRN (chemical, biological, radiological and nuclear defence) emergencies, chemical leaks, emergency response, hazmat response, maintenance of plant and machines, plant emergencies, tank cleaning, unexpected leakages spills or other releases. It must be noted that CPC suit must follow the requirements of these European norms:

- EN 943-1 Protective clothing against dangerous solid, liquid and gaseous chemicals, including liquid and solid aerosols. Performance requirements for Type 1 (gas-tight) chemical protective suits;
- EN 943-2/ET Protective clothing against liquid and gaseous chemicals, including liquid aerosols and solid particles - Part 2: Performance requirements for gas-tight (Type 1) chemical protective suits for emergency teams (ET);
- EN 1073-2 Protective clothing against radioactive contamination. Requirements and test methods for non-ventilated protective clothing against particulate radioactive contamination;

- EN 14126 Protective clothing. Performance requirements and tests methods for protective clothing against infective agents.

The view of Trellech®VPS encapsulating CPC clothing (type 1a) together with the scheme of its welded seams is presented in Figure 6. It must be also noted that this CPC suit must be used in temperature ranges -40°C till +65°C and never near open flames or intense heat. The risk of heat stress must always be taken into account when working in coveralls and encapsulating suits. Depending on the type of work and clothing this risk may be considerable even at moderate ambient temperatures [132].

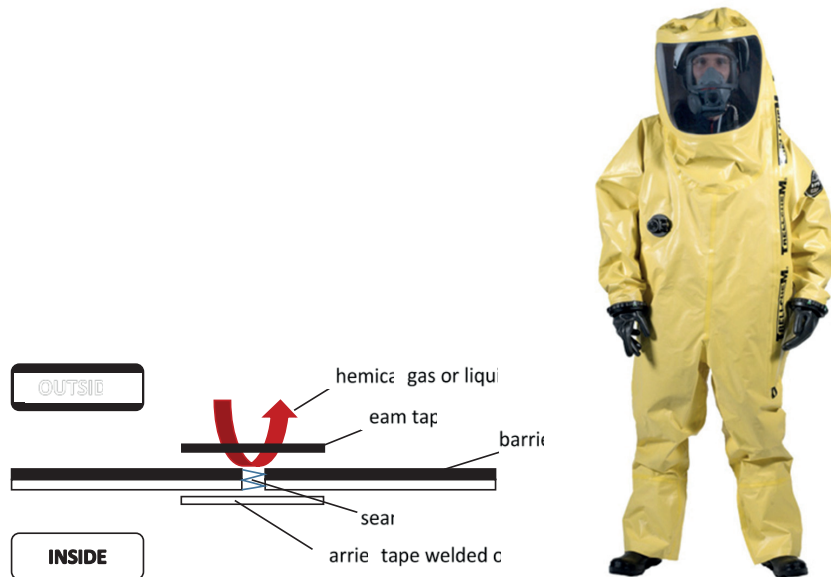


Figure 7.6. The view of Trellech®VPS encapsulating CPC clothing (type 1a) and the scheme of its welded

### 7.8. The assessment of CPC suits functionality by Lithuanian firefighters

The questionnaire was developed in order to analyze the level of functionality and comfort of Trellech®VPS encapsulating CPC suit (type 1a). Totally 53 firefighters participated in the survey. The results of the survey are as follows:

1. Are you familiar with the CPC suit:
  - Type A (suit with visor, breathing gear inside the suit) **49 from 53**
  - Type B (suit with face gum, breathing gear outside the suit) **42 from 53**
2. Have you been wearing CPC suit and how many times:



- during training **51 from 53**
  - in the situation of a real danger **1 from 53**
  - no **1 from 53**
3. Do you feel comfortable while performing tasks in CPC suit? Please comment briefly.
- Yes **13 from 53 (24,5 percent)**
  - No **40 from 53 (75,5 percent)** (Fig. 7.7)
  - Comments: glass dew; restricted movements; uncomfortable to use communication tools; difficult to talk to partner; limited visibility; impossible to dress up without the help from outside; difficult to communicate through communication means; not possible to self-open the suit in the face of danger that air ends up in the balloon; inconvenient to move; glove rubber could be softer, because its limits hand movements.

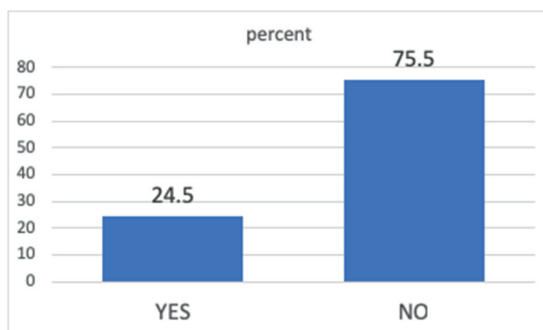


Figure 7.7. The answers show that the majority of questioned are not satisfied with the comfort of CPC suit due to restricted movements and communication, limited visibility

4. Is it convenient to use existing communication tools and make contact with the partner in CPC suit?
- Yes **8 from 53 (15,0 percent)**
  - No **45 from 53 (85,0 percent)** (Fig. 7.8)
  - Comments: hard to communicate; in order to press the communication button for answer you need to pull your hand out the sleeve inside the suit; hand-free radio communication is needed; hard to hear what is happening outside; requires convenient buttons to control communication tools; cannot use radio communication properly, because our tools are simple and practically it is impossible to use and control them with type A suits; hard to understand spoken words.

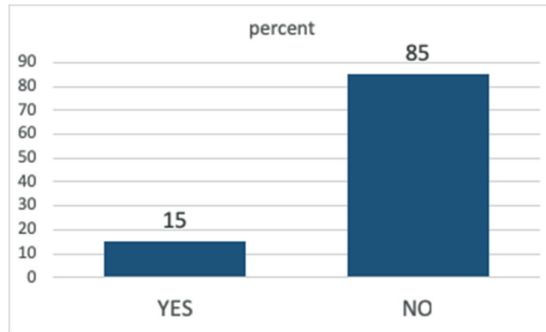


Figure 7.8. The answers show that the majority of questioned are not satisfied with the quality of communication while wearing CPC suit due to uncomfortable push-buttons on radio station, etc.

5. Do you use the same communication tools in chemical hazards situations as in the situations without chemical hazards, e.g. firefighting?
  - Yes **49 from 53**
  - No **4 from 53**
  - Comments: no
  
6. Do you use additional tools for communication, e. g. visual or audible alarms, etc.?
  - Yes **15 from 53**
  - No **38 from 53**
  - Comments: gesture language; audio signal for evacuation - three short beeps repeated many times; the machine's audible signal is used and spotlight as visual signal.
  
7. What would you like to improve in communication, e.g. large external PPT button or additional external Wireless PPT button, etc.?
  - Yes **44 from 53**
  - No **9 from 53**
  - Comments: everyone agrees the need to improve communication, but there is no common opinion; wireless PPT button (5); large external button (8); to install communication support – speaker.
  
8. What actions are taken when the contact with a partner wearing CPC suit is lost? Is the sequence of actions regulated by approved documents?
  - Comments: gesture signs; gesture language, light; the second partner is helping; partners search; if the connection is lost and the partner of the same chain can't help the second chain in CPC suits is sent for rescue; the attempts are made to restore the connection, if these attempts are not successful returning to the "clean" point; lifting hands up; the movements regulated by documents are hand gestures to go into "clean" point.
  
9. How to understand without radio communication that a partner in CPC suit needs help?
  - Comments: from mutual understanding; from gestures; from hand signs; the partner does not carry out his assigned work; partner takes inappropriate actions; the partner does not move; the partner starts shouting; from the contractual signs.

10. Is there a need for a feedback to the communication operator?

- Yes **49 from 53**
- No **4 from 53**
- Comments: no

11. What is maximal duration of one operation when wearing full breathing gear and a CPC suit?

- Comments: 15 min; about 20 min; up to 20 min; up to 30 min with our gear; 30 - 60 min; due to compressed air amount; depends on how much compressed air is in the balloon and how long it lasts until the incident place is reached; 10 min; depends upon the capacity of the balloon; when wearing full breathing gear maximal time is up to 30 min and with the CPC suit - up to 20 min; according to KOAA monomer data; in respect to the type and complexity of work - up to 30 min.

12. What additional items do you take with when going to the incident place (e.g. radio transmitter, keys, phone, screwdriver, knife, etc.)?

- Comments: lamp; crowbar; radio station; rope; spotlight; dispenser; hand tools; phone; knife; pneumatic equipment; sealing equipment; hose with water; a fire hose with a syringe; stretchers; depending on the incident.

13. If you take additional items, how and where do you insert or attach them?

- Comments: taking into arms; taking in hands or boxes; in adapted trays; putting across the shoulder if there is a belt and taking in hands; on the belt; only taking in hands, except ropes, which are in special cases and are put on the shoulders; attached to clothes; put in the pocket; crowbar and syringe taking in hands and spotlight putting on the shoulders.

14. Would it be convenient to wear a textile holder for additional items (communication tools, keys, etc.) along with the CPC suit?

- Yes **48 from 53**
- No **5 from 53**
- Comments:

15. Check which design of textile holder for the extra items is the most convenient for you (samples from the company Urban Tools [21]).

a) vest shaped  
**31 from 53**



b) attached under armpit  
**8 from 53**



c) attached to the belt and leg  
**14 from 53**



16. What do you think the CPC costume and accessories should be to make them as comfortable and functional as possible during work?

- Comments: integrated communication tools; visor with protection against dew; with solved sound transmission and hearing problems; more comfortable and lighter suit; the suit should be comfortable, allow free movements, convenient to use radio communication; accessories could be outside the suit; built-in chat unit, ventilation; an important feature is the ability to dress yourself out of the suit; lightweight, quick-fitting and comfortable to make specific task movements; an inside zipper is needed; sleeve ends must match the size of the hands and be tight; better visibility.

From all above it may be stated that there are three main problems, that must be solved while wearing fully encapsulated chemical protection clothing CPC in real situations by developing relevant prototypes:

**1) wireless communication prototype between two partners of rescue chain and centre control point;**

**2) smart vest prototype for constant monitoring of firefighters physiological parameters during the performed task in order to know the effect of work load and also taking into account the impact of gear and CPC suit upon his physical state;**

**3) the unit for remote surface temperature control in order to avoid the damage of CPC suits material, which may cause the decrease of its protection against chemical hazards.**

### **7.9. 1st prototype. Wireless communication module based on RF transmission**

Rescue team actions must be carried out under the protocol according to which rescuers must wear chemical protective clothing CPC against chemical hazards. The operations are expected to take about 15 - 20 min due to the limited amount of oxygen in gear balloons. The protocol uses one radio station, which contacts with the central control point. The operation involves two rescuer partners, the distance between whom must be at an arm length. In real situations it is difficult for the partner without radio station to be guided without knowing the action plan for the current situation and always relying on the signs of the first partner. The voice conversation between them is physically difficult due to the CPC suit, breathing mask and helmet (Fig. 7.9).

Therefore communication system was developed that broadcasts the communication of the first rescuer partner with the central control point by 2.4 GHz radio frequencies. In this way the second rescuer partner knows current situation by having radio frequency RF receiver in

the form of a free-hand headset. At the moment action protocol allows only one radio station to be present. The developed system does not compromise this requirement, because it only transmits a signal from the first partner and works as a transmitter. Thus, it is enough for the second partner to have an autonomous RF receiver and he can listen to the conversation between the first rescuer and the control point.



Figure 7.9. Communication radio station [135], helmet and breathing mask [134] of firefighters

The information from the central control point to the first rescuer is transmitted through the communication channel – radio station. The first rescuer is responsible for the operation execution and therefore has a communication tool according to the protocol. The 1st prototype for RF transmission based communication is developed by adding to the existing system three additional devices. For the first partner of a rescue chain - 1) Push-To-Talk (PPT) button, which allows to switch on/out radio station with rubber gloves from the outside of encapsulated CPC suit and 2) earpiece with bone microphone, which is easily integrated into the helmet. For the second partner of rescue chain - 3) headset for hands-free sound receiving (Fig. 7.10).

PPT button works as interface between radio and earpiece/microphone in the helmet. The convenient earpiece with bone conduction microphone is voice sensitive and makes a perfect combination with a breathing mask. It works as compact and lightweight receiver/transmitter unit, which can be adapted to different helmet shapes and enable immediate, clear and reliable communication [136]. In order for the second rescuer to be aware of the existing situation and to listen to the first rescuer, he has a receiver module with a headset that receives a signal from the transmitter built into the standard first rescue equipment. This method of connection is not in contradiction with the existing action protocol and can be used for rescue operations. The connection can be broadcasted at a distance up to 1 km away. In tested case the distance was

100 m (Fig. 7.11). The whole communication system of the 1st prototype is inside the CPC suit, thus additional inside pocket for it is constructed on the inner side of suits front part.



a) push-to-talk PTT button and bone microphone



b) headset

Figure 7.10. Additional devices for free hand communication inside the encapsulated CPC suit:

- a) push to talk PTT button; b) microphone for taking and transmitting the sound from the bones of the first rescue partner; c) headset for hands-free sound receiving [135]

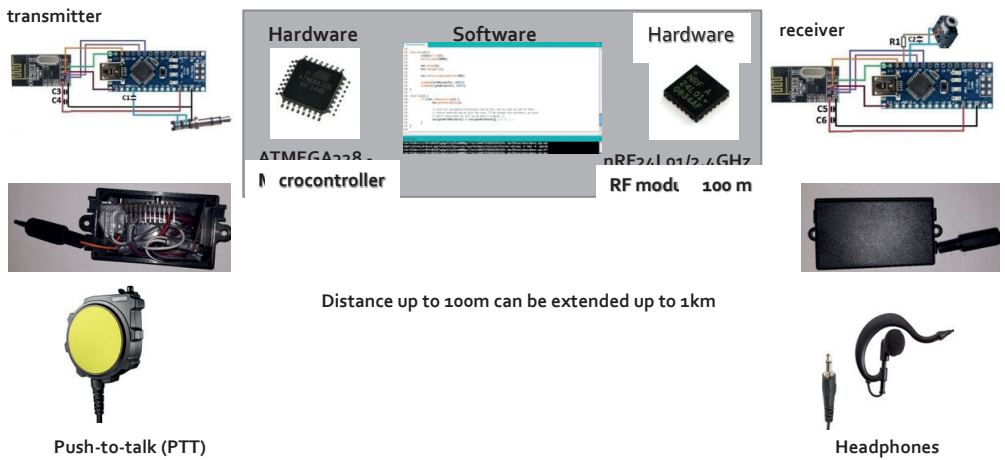


Figure 7.11. The scheme of radio frequency (RF) based communication under the CPC suit

The transmitter and receiver are developed using the Arduino (an open source platform for electronic products) nano controller and the transmitting/receiving NRF24L01 module, which operates at 2.4 GHz frequency. Arduino consists of ATmega328 microcontroller and software. Such a module requires a stable 3.3V voltage, thus AMS1117 voltage stabilization module must be added (Fig. 7.12).

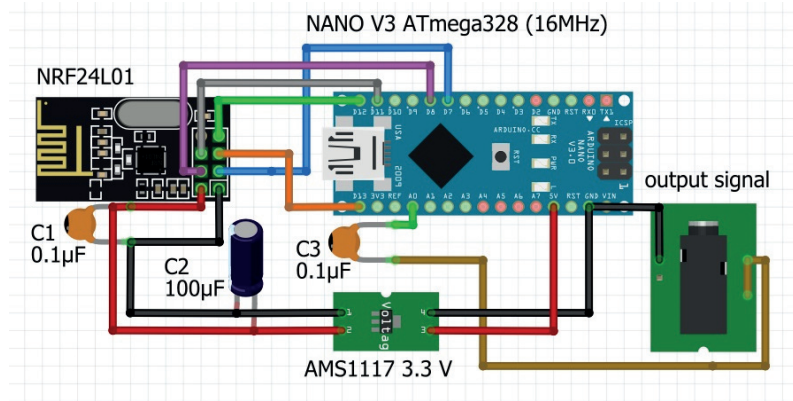


Figure 7.12. Transmitters assembly scheme

In our case the Arduino nano controller was replaced with a modified version of Arduino nano v3 (16MHz) with a 3.3 V voltage stabilizer, making the scheme simpler. Capacitors C1 and C2 are needed to filter high and low power noise (Fig. 7.13). Software programming code of transmitter is presented in Annex 1.

The receiver assembly scheme is slightly different from the transmitter, because receiving signal connection was changed and RC filter (R1, C3) was used to filter the incoming signal band (audio frequency band 20Hz to 20kHz) while leaving a certain audio transmission band (Fig. 7.14). Also a modified version of the 3.3 V voltage stabilizer was added (Figure 7.15). Software programming code of receiver is presented in Annex 1.

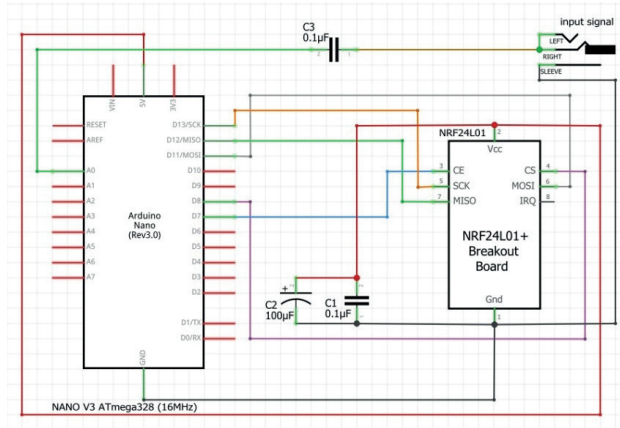


Figure 7.13. Principal electronic diagram of transmitter

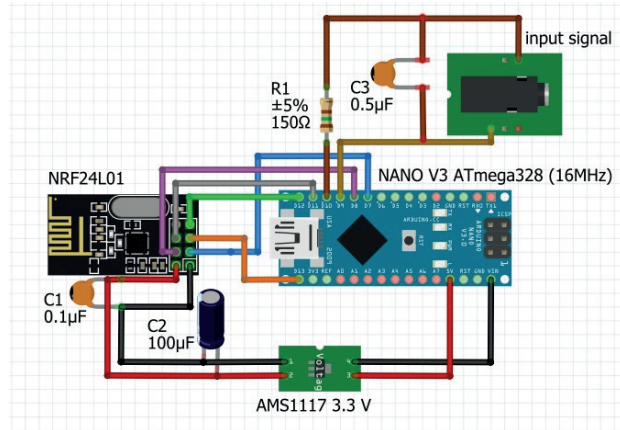


Figure 7.14. Receiver assembly scheme



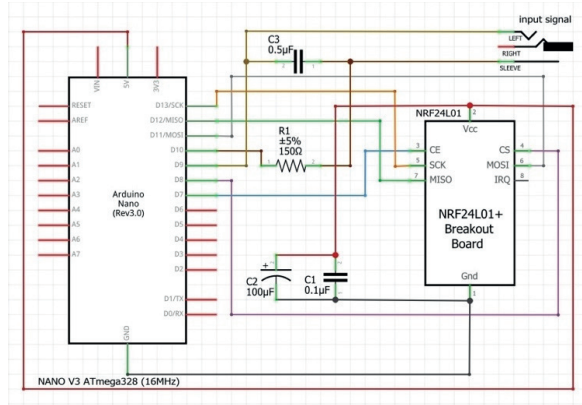


Figure 7.15. Principal electronic diagram of receiver

The prototype of radio frequency based RF communication system, besides transmitter and receiver, also has rechargeable lithium ion batteries (via USB), the operation of which is scheduled for 30 min. This is in accordance with the duration of rescue operations, which are dependent upon the amount of compressed air in breathing balloons, i.e. 15 – 30 min. The quality of the operation of prototype system was tested and evaluated by firefighters of Taurage County Fire Rescue Board, the feedback of which was very positive (Fig. 7.16)



Figure 7.16. The moment of testing and helmet with integrated earpiece – bone microphone

### **7.10. 2nd prototype. Smart vest for firefighters health state and physiology monitoring**

The second task of WP3 was to develop an electronic system that could not only capture human physiological parameters (pulse, temperature, etc.), but also would be able to collect and to transfer data about the state inside the closed system (ambient humidity, temperature, pressure, motion detection, etc.). Such system had to be compact, reliable and cheap. The other important moment – it had to be integrated into the vest, which was worn by firefighter under the encapsulated chemical protective clothing CPC (Fig. 7.17).

For this purpose a NodeMCU V3 LUA WiFi controller was selected, based on the ESP8266 microcontroller, which can connect remotely to a Wi-Fi network. Controller tactical frequency 80MHz (flash memory: 4MB). This type of controller can be programmed from the Arduino environment. It is a small controller (49 x 24.5 x 13 mm) and fast in its class, the price of which is not high. Such controller has 10 GPIO one analogy input, as well as UART, I2C, SPI, ADC connections and can connect directly to the Wi-Fi network. So it can easily be connected to various electronic accessories - in our cases humidity, motion, temperature, pressure and pulse sensors. The controller has a micro USB connector for power supply, programming and tuning so it can be easily programmed.

The controller was fitted with sensors, the parameters of which are presented in Table 7.1. Full description of all applied sensors are presented in Annex 4. Ambient humidity was measured using AM2301 (DHT21 / DHT22 version) sensor. It uses a capacitive humidity sensor that measures ambient air and provides data via a digital signal (no analogy input inverters required). It is easy to use, but needs careful data monitoring. The digital signal is easily understood with any controller, like NodeMCU V3 LUA WiFi. The only real drawback of this sensor is that data can be received once every 2 seconds.

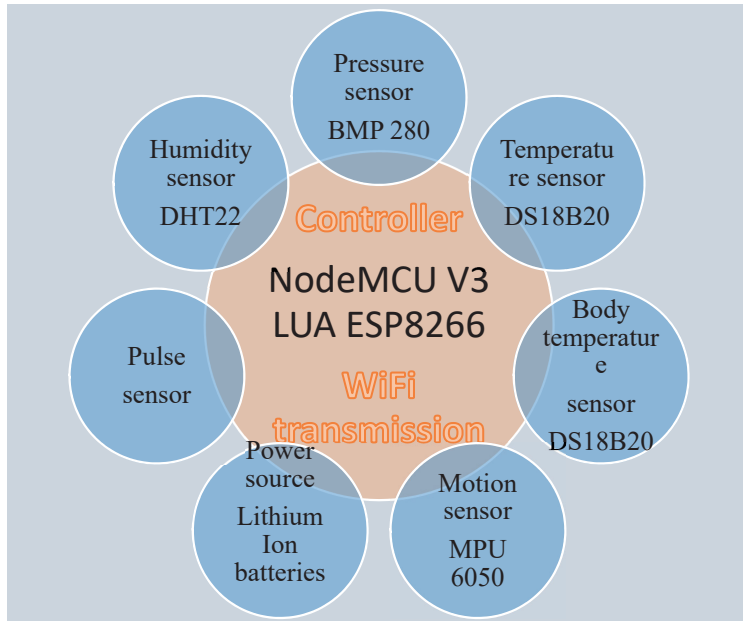


Figure 7.17. Electronic scheme of smart vest

Table 7.1. Short specification of smart vest sensors (detailed specifications in Annex 4)

Sensor	Specification
Temperature sensor Dallas DS18B20 (for body and ambient temperatures )	temperature range: from -55 up to 125 ° C (± 0,5 ° C accuracy at the temperatures from -10 ° C up to + 85 ° C)
Ambient humidity sensor AM2301 (DHT21/DHT22)	0 – 100 % humidity measurement with 3 % accuracy
Pulse sensor	diameter ~16mm
Ambient pressure sensor BMP280 Bosch	300...1100 hPa
Other options:	
Ambient pressure Smartec SPD005G	(0...35) kPa ± 0.3%
Gyroscope MPU 6050	(250, 500, 1000 and 2000) ° sec

Pulse sensor in smart vest was used to monitor heart rate. The applied sensor was the upgraded version of original pulse sensor into the heart rate sensor version and well adapted for the microcontroller. Essentially, it consists of an optical heart rate sensor with amplifier and a

noise suppression scheme, providing reliable pulse readings quickly and easily. In addition, its current consumption is only 4mA, making it ideal for mobile systems.

The electronic system of smart vest can be upgraded by adding additional sensors, e.g. for absolute pressure Smartec SPD005G, which allows to capture pressure change in leakage (BMP280 Bosch's atmospheric pressure sensor is currently connected). Gyroscope MPU 6050 can be used to capture position of axes in order to track the movement of firefighter in CPC suit. Assembly scheme of main controller together with its principal electronic diagram are presented in Figure 7.18 and Figure 7.19. Software programming code is presented in Annex 2. The information obtained from all sensors is collected and displayed using commercial software *Cayenne* (Fig. 7.20) [137].

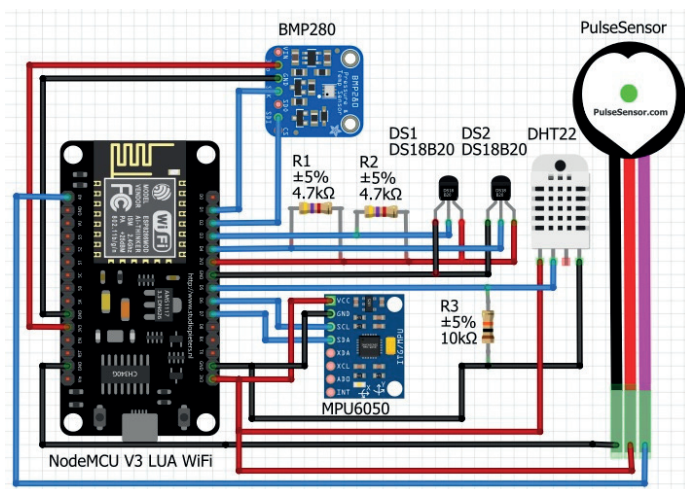


Figure 7.18. Smart vest controllers assembly scheme

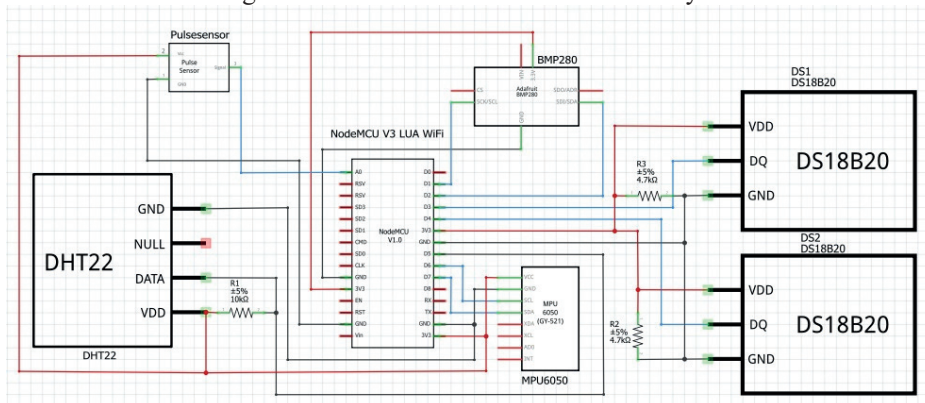


Figure 7.19. Principal electronic diagram of smart vest main controller

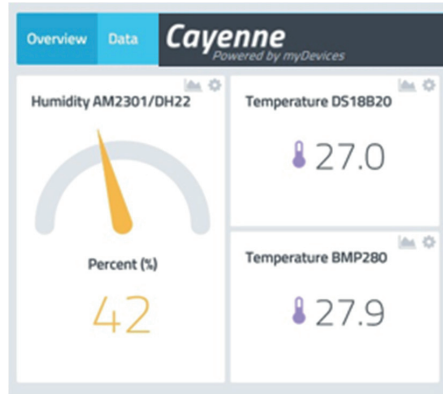


Figure 7.20. The display of commercial software *Cayenne*

Main controller together with all sensors was integrated into the vest, which was worn by firefighters under the CPC suit. Its design with optimal positions of sensors is presented in Figure 7.21.

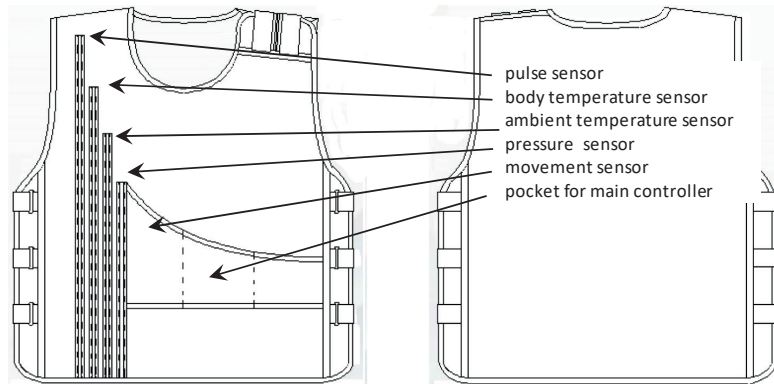


Figure 7.21. Front and back view of smart vest together with the positions of integrated sensors and main controller

Two temperature sensors (body surface and ambient), as well as ambient humidity sensor were tested in real situations. Room temperature during testing was 25 degrees Celsius. Volunteers were dressed in light clothing. They were wearing full breathing gear – helmet, breathing mask, balloons filled with compressed air and CPC suit. Total weight of full equipment was 32 kg. Testing and real-time digital measurement recording was performed for 10 min. During testing volunteers had to perform movements, imitating real rescue tasks, i.e. to walk, to crouch, to raise hands, etc.

The sensor recording body surface temperature was attached to the skin under the left ear. Figure 7.22 presents the recorded data of two volunteers. It can be seen that the increase of temperature during the period of 11 minutes is very similar for both persons. For the first one (blue line) it has risen from 33.5°C up to 35.5°C and for the second person (orange line) half a degree higher, i.e. up to 36.0°C. Thus the rise of body surface temperature was recorded to be 2.0°C – 2.5°C.

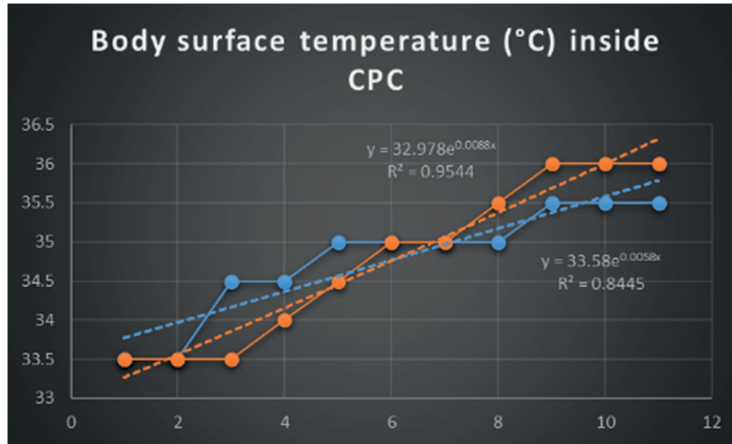


Figure 7.22. The rise of body surface temperature during testing was recorded in the limits of 2.0°C – 2.5°C

During testing the sensor of ambient temperature was hanging free under the CPC suit just between the body of the volunteer and the inner layer of the suit. It can be seen (Fig. 7.23) that for the first person in 11 minutes it has risen from 28.5°C up to 29.5°C , i.e. by one degree. Meantime for the second person (orange line) the increase was very significant during the first minute of task performance – from 29.0°C up to 30.5°C (by 1.5 degree). While later, in the period of 10 minutes it has risen up to 31.5°C, i.e. by one degree, as it was in the case of the first volunteer.

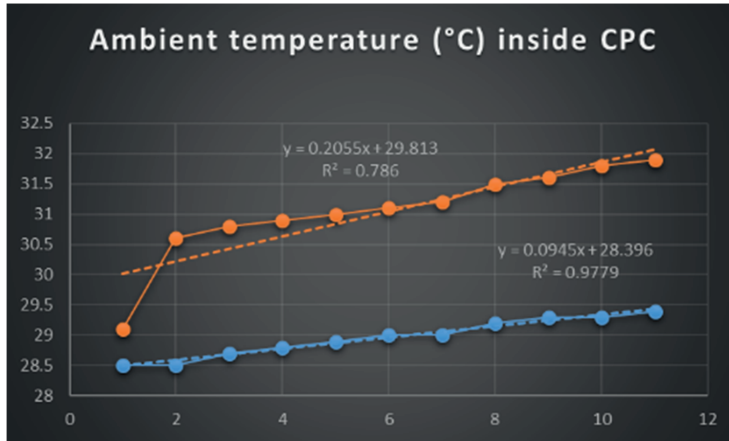


Figure 7.23. The difference in ambient temperature changes under the CPC suit for two volunteers

Ambient humidity under the CPC is highly related with the perspiration level of human body. During testing the sensor of ambient humidity was also hanging free under the CPC suit, as it was in the case of ambient temperature sensor. Figure 24 shows that during 11 minutes humidity has increased by 30 – 35 percent in the cases of both volunteers, i.e. from about 50 percent up to 85 percent. It proves that due to totally impermeable barrier material of CPC the comfort of such clothing is unacceptable and additional ventilation must be always used.

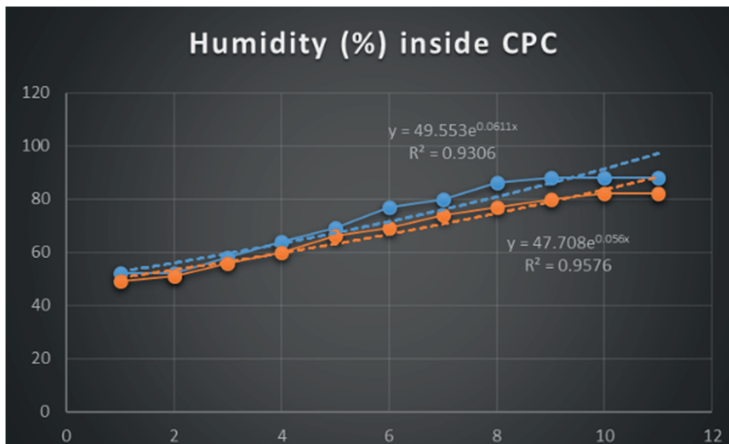


Figure 7.24. The rise of ambient humidity during testing was recorded to be 30 – 35 percent

### 7.11. 3rd prototype. The unit for remote surface temperature control

The prototype of the unit for remote surface temperature control was developed in order to avoid the damage of CPC suits material, which may cause the decrease of its protection against chemical hazards. For this purpose, an infrared (IR) temperature gauge was applied, temperature range of which is between  $-33^{\circ}\text{C}$  and  $220^{\circ}\text{C}$  with a tolerance of  $\pm 2\%$  ( $2^{\circ}\text{C}$ ). It is enough to direct it to the surface or other heat source so that their temperature can be remotely measured. A module with RB-Fee-24 IR temperature sensor with an optical range of 1: 1 was used. The developed unit is attached to arm zone where rubber glove is joint to CPC suit so, that it can be directed to the object using a laser to measure the temperature (Fig 7.25).

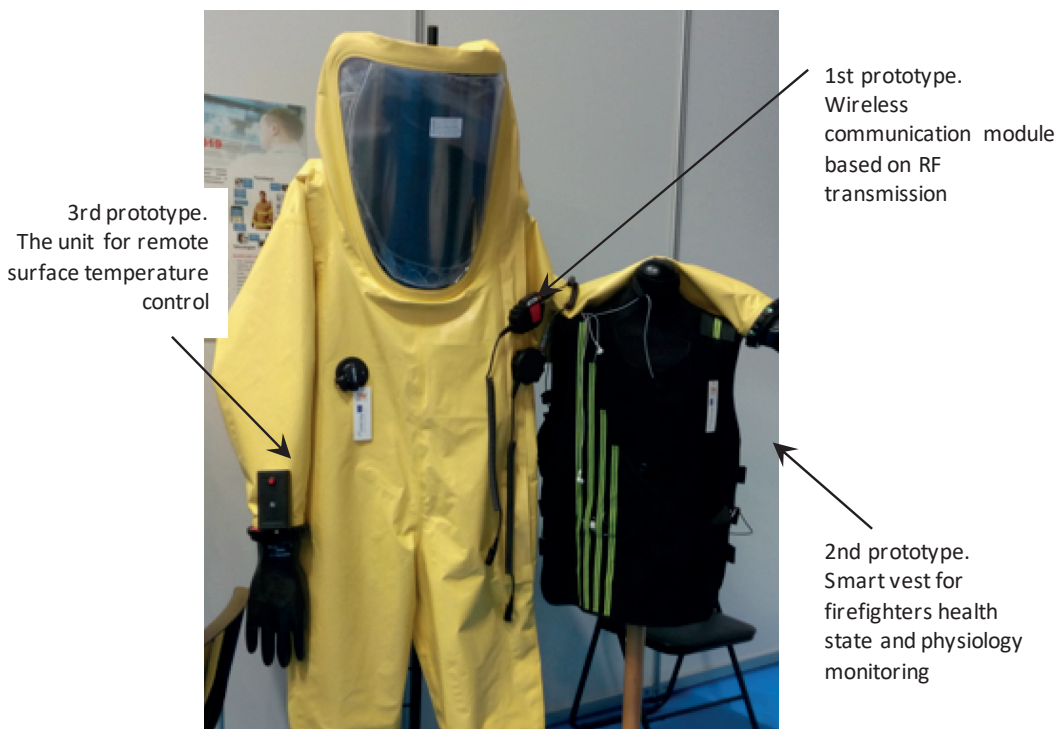


Figure 7.25. Three prototypes of safe CPC suit

The KY-008 module consists of a laser diode which emits a visible red light of a 650 nm. For the control the Arduino Mini Controller incorporating ATmega328is used. Such a solution is suggested by the fact that holding a standard IR thermometer is inconvenient. The meter is designed to measure three temperature ranges and has three colour rendering modes. A 7-color LDTR-B00010 10mm RGB LED is used. In the low temperature range from  $-33^{\circ}\text{C}$  up to  $18^{\circ}\text{C}$



the RGB LED lights up blue. In the average range from 18°C to 35°C - lights up green and in the high temperature range from 35°C to 220°C - lights up red. The temperature ranges and rendering colours can be changed according to the customers wishes, as the RGB colour diode and the temperature sensor operate in the wide temperature range from -33°C to 220°C (Fig. 7.26). The assembly scheme of remote surface temperature control unit and its principal electronic diagram are presented in Figure 7.27 and Figure 7.28. Software programming code is presented in Annex 3.

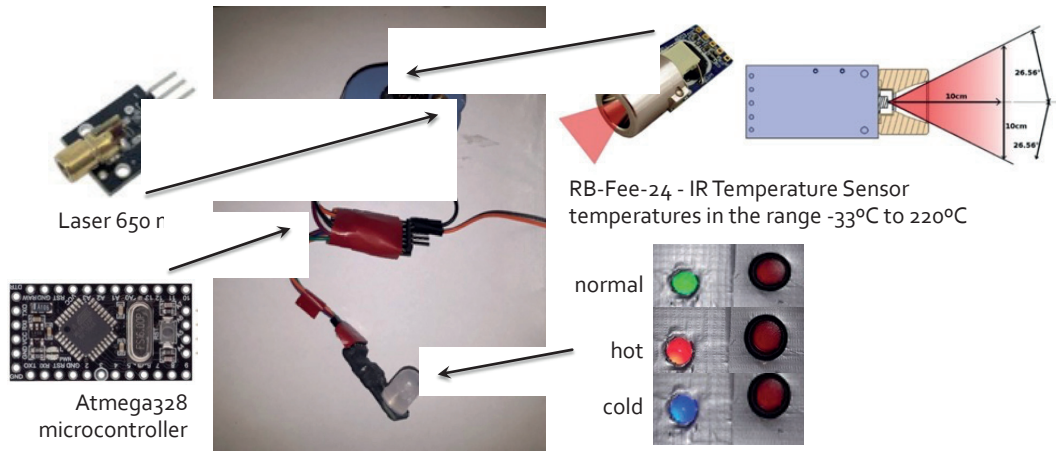


Figure 7.26. The unit for remote surface temperature control

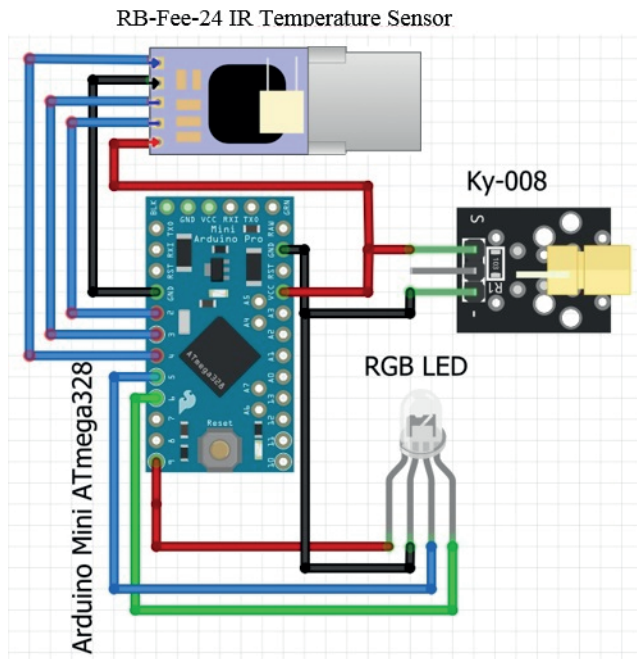


Figure 7.27. The assembly scheme of remote surface temperature control unit

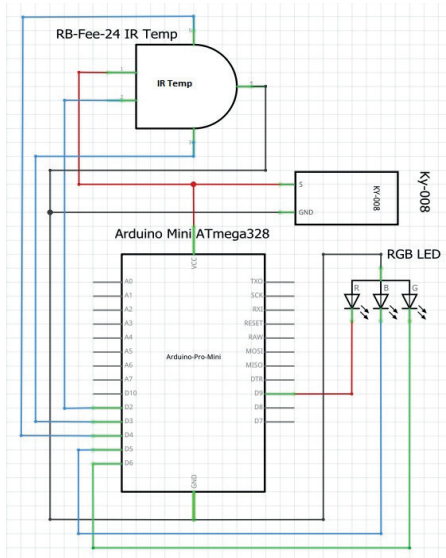


Figure 7.28. Principal electronic diagram of remote surface temperature control unit

## CONCLUSIONS

Research and development of uniforms and workwear must be a continuous process. It should cover the entire range of activities from prospective scientific studies to the practical application. Advanced 3D design technologies should be coupled with the study of functional and ergonomic features of materials and joints. It is necessary to identify, systematize and employ experience in international research projects. Such works can be carried out by a specialized interdepartmental research organization – a centre of uniform competence, the key units of which include: a laboratory for testing textile materials and joints, a design department and an implementation department.

PPE technical specifications are one of the types of documents in which binding requirements of suppliers should be formulated in a technically unambiguous terms. If a customer has not expressed them clearly and accurately, then it impossible to discuss further improvement of the quality of PPE and to inspect it, since there are no criteria for next actions. Terminology of any industry I comprised of a system of interrelated terms reflecting the system of the concepts of this particular industry in language. In contrast to words from everyday language, terminology of a particular science field expresses (denotes and marks) definite concepts with precise boundaries of meaning. Signs of a scientific term include systematism, accuracy of meaning, shortness of form, unambiguousness, mononymity, contextual independence, emotional neutrality, etc. In today's diversity of materials and the complexity of PPE, it is not always enough to have a precise, terminologically respective specification. Studies on materials and their systems in a specific area determine spectrum of their application.

The use of electronic systems in PPE will increase employee safety by improving their visibility, improving their comfort of use and safety in the event of a threat by identifying their location and possible rapid interventions. The introduction of innovative solutions will also reduce the absenteeism of employees for health reasons, and thus the necessary changes in workplaces filled by inexperienced persons, which is beneficial to the employer in terms of reducing potential costs.

Additionally, through the implementation of RFID technology, the employer has the opportunity to: registering multiple data at the same time, assigning clothing to a specific employee, with the option of changing employee data, restrictions on access of unauthorized persons.

In the design of special and work clothing, functional requirements are emphasized. For garments to be designed to meet specific work conditions, materials and design solutions to protect the user from hazardous working environment, climate conditions and microclimate parameters are assessed, the design elements of the garment and their adjusting possibilities – fasteners, pockets, tightening etc. – are selected according to the type of work in question, as well as end-user training or information provision procedure is planned. In view of functional requirements, workwear designs or elements are very easily united, which in a full-scale production can save resources of both the designing and the production.

## REFERENCES

- [1] R. F. Goldman un B. Kampmann, Handbook on Clothing, Biomedical Effects of Military Clothing and Equipment Systems 2nd Edition, 2007, p. 321.
- [2] EN ISO 13688:2013 Protective clothing - General requirements
- [3] EN ISO 11079:2007 Ergonomics of the thermal environment - Determination and interpretation of cold stress when using required clothing insulation (IREQ) and local cooling effects
- [4] EN ISO 8996:2004 Ergonomics of the thermal environment - Determination of metabolic rate
- [5] EN ISO 7933:2004 Ergonomics of the thermal environment - Analytical determination and interpretation of heat stress using calculation of the predicted heat strain
- [6] EN ISO 20471:2013 High visibility clothing - Test methods and requirements
- [7] Directive 89/686/EEC - personal protective equipment
- [8] EN 342:2017 Protective clothing. Ensembles and garments for protection against cold
- [9] EN 343: 2003 +A1:2007 Protective clothing. Protection against rain
- [10] EN ISO 13937-2:2000 Textiles - Tear properties of fabrics - Part 2: Determination of tear force of trouser-shaped test specimens (Single tear method)
- [11] EN ISO 13934-1:2013 Textiles - Tensile properties of fabrics - Part 1: Determination of maximum force and elongation at maximum force using the strip method
- [12] EN ISO 12947-2:2016 Textiles - Determination of the abrasion resistance of fabrics by the Martindale method - Part 2: Determination of specimen breakdown
- [13] EN ISO 4920:2012 Textile fabrics - Determination of resistance to surface wetting (spray test)
- [14] EN ISO 6330:2012 Textiles - Domestic washing and drying procedures for textile testing
- [15] EN ISO 5077:2007 Textiles - Determination of dimensional change in washing and drying
- [16] EN ISO 11092:2014 Textiles - Physiological effects - Measurement of thermal and water-vapour resistance under steady-state conditions (sweating guarded-hotplate test)
- [17] EN ISO 105-C06:2010 Textiles - Tests for colour fastness - Part C06: Colour fastness to domestic and commercial laundering
- [18] ISO 105-X12:2016 Textiles - Tests for colour fastness - Part X12: Colour fastness to rubbing

- [19] EN ISO 105-E04:2013 Textiles - Tests for colour fastness - Part E04: Colour fastness to perspiration
- [20] “Recommendation Concerning Characteristics And Faults In Fabrics To Be Used For Clothing” recommended by the European Clothing and Textile Confederation EURATEX. 2006. Source: [https://s3-eu-west-1.amazonaws.com/stjm/ECLA\\_suositus\\_kankaiden\\_laatuvaatimukset\\_2006.pdf](https://s3-eu-west-1.amazonaws.com/stjm/ECLA_suositus_kankaiden_laatuvaatimukset_2006.pdf)
- [21] BS 3356:1990 Method for determination of bending length and flexural rigidity of fabrics
- [22] ASTM D1388 – 18 Standard Test Method for Stiffness of Fabrics
- [23] EN ISO 3071:2006 Textiles. Determination of pH of aqueous extract
- [24] ISO 105-A02:1993 Textiles - Tests for colour fastness - Part A02: Grey scale for assessing change in colour
- [25] ISO 3175-1:2017 Textiles - Professional care, drycleaning and wetcleaning of fabrics and garments - Part 1: Assessment of performance after cleaning and finishing
- [26] EN 469:2014 Protective clothing for firefighters - performance requirements for protective clothing for firefighting
- [27] ISO 1421:2016 Rubber- or plastics-coated fabrics - Determination of tensile strength and elongation at break
- [28] ISO 13935-2:2014 Textiles - Seam tensile properties of fabrics and made-up textile articles - Part 2: Determination of maximum force to seam rupture using the grab method
- [29] ISO 4674-1:2016 Rubber- or plastics-coated fabrics - Determination of tear resistance - Part 1: Constant rate of tear methods
- [30] EN ISO 811:2018 Textiles. Determination of resistance to water penetration. Hydrostatic pressure test
- [31] Requirements for workwear developed by the European Textile Service Association (ETSA). 2016. Source: [file:///F:/SWW\\_WP3\\_2019/ETSA%20Requirements%20for%20workwear%20fabrics.pdf](file:///F:/SWW_WP3_2019/ETSA%20Requirements%20for%20workwear%20fabrics.pdf)
- [32] ISO 3801:1977 Textiles - Woven fabrics - Determination of mass per unit length and mass per unit area
- [33] ISO 12945-2:2000 Textiles - Determination of fabric propensity to surface fuzzing and to pilling - Part 2: Modified Martindale method
- [34] ISO 15487:2018 Textiles - Method for assessing appearance of apparel and other textile end products after domestic washing and drying

- [35] ISO 105 - N01 Textiles - Tests for colour fastness - Part N01: Colour fastness to bleaching: Hypochlorite
- [36] ISO 105-E01:2013 Textiles - Tests for colour fastness -- Part E01: Colour fastness to water
- [37] ISO 105-B02:2014 Textiles - Tests for colour fastness - Part B02: Colour fastness to artificial light: Xenon arc fading lamp test
- [38] Regulation (EU) No 1007/2011 of the European Parliament and of the Council. 2011.  
Source: <https://eur-lex.europa.eu/legal-content/en/TXT/?uri=CELEX%3A32011R1007>
- [39] EN 1049-2:1994 Textiles. Woven fabrics. Construction. Methods of analysis.  
Determination of number of threads per unit length
- [40] ISO 7211-5:1984 Textiles - Woven fabrics - Construction - Methods of analysis - Part 5:  
Determination of linear density of yarn removed from fabric
- [41] EN 1773:1997 Textiles. Fabrics. Determination of width and length
- [42] EN 12127:1998 Textiles. Fabrics. Determination of mass per unit area using small samples
- [43] EN ISO 9237:1995 Textiles - Determination of the permeability of fabrics to air
- [44] ISO 105-D01:2010 Textiles - Tests for colour fastness - Part D01: Colour fastness to drycleaning using perchloroethylene solvent
- [45] ISO 105-X11:1994 Textiles - Tests for colour fastness - Part X11: Colour fastness to hot pressing
- [46] ISO 14419:2010 Textiles - Oil repellency -- Hydrocarbon resistance test
- [47] ISO 6530:2005 Protective clothing - Protection against liquid chemicals - Test method for resistance of materials to penetration by liquids
- [48] ISO 15025:2016 Protective clothing - Protection against flame - Method of test for limited flame spread
- [49] ISO 3758:2012 Textiles - Care labelling code using symbols
- [50] ISO 5084:1996 Textiles - Determination of thickness of textiles and textile products
- [51] ISO 2062:2009 Textiles - Yarns from packages - Determination of single-end breaking force and elongation at break using constant rate of extension (CRE) tester
- [52] EN 12590:2000 Textiles. Industrial sewing threads made wholly or partly from synthetic fibres
- [53] EN 14704-1:2005 Determination of the elasticity of fabrics. Strip tests
- [54] EN ISO 139:2005+A1:2011 Textiles - Standard atmospheres for conditioning and testing

- [55] ISO 11612:2015 Protective clothing - Clothing to protect against heat and flame - Minimum performance requirements
- [56] ISO 11611:2015 Protective clothing for use in welding and allied processes
- [57] Sybilska, W. Frydrych, I., 2007, Perspektywy i kierunki rozwoju odzieży inteligentnej, Przegląd Włókienniczy - Włókno, Odzież, Skóra, nr 2, str. 50-53, wyd. SIGMA-NOT
- [58] Bendkowska W. 2002. „Tekstylna inteligentna - przegląd zastosowań, cz. II: Tekstylna elektroprowadząca i tekstylna zintegrowana z mikrosystemami elektronicznymi”. Przegląd Włókienniczy, nr 9, str. 16-19, wyd. SIGMA-NOT
- [59] Bartkowiak G. 2010. „Kierunki rozwoju odzieży inteligentnej”. Bezpieczeństwo Pracy - Nauka i Praktyka nr1, str 18-22
- [60] Gniotek K., Frydrych, I., 2010, „Systemy tekstroniczne w mechatronice”. red. S. Wiak. Mechatronika tom 2, Łódź
- [61] Walczak S., 2012, Inteligentne tekstylna- międzynarodowe innowacje w tekstronice, Acta Innovations, nr 3, str.103-122
- [62] Główny Urząd Statystyczny, opracowanie sygnałowe z dnia 21.03.2017, „MONITORING RYNKU PRACY. Wypadki przy pracy w 2016r.”, Warszawa
- [63] CIOP-PIB, 2008, Wypadki w budownictwie. Przyczyny, skutki, zapobieganie, Ogólnopolska kampania społeczna RYZYKO ZAWODOWE W BUDOWNICTWIE organizowana w ramach Europejskiej Kampanii na rzecz Oceny Ryzyka Zawodowego. Zdrowe i bezpieczne miejsce pracy. Dobre dla ciebie. Dobre dla firmy
- [64] Barbara Krzyśków i współautorzy, 2015, BADANIE WYPADKÓW PRZY PRACY. Materiał źródłowy dla uczestników szkolenia CENTRALNY, INSTYTUT OCHRONY PRACY- PAŃSTWOWY INSTYTUT BADAWCZY
- [65] <https://pl.aliexpress.com/w/wholesale-reflective-led-vest.html>
- [66] Andrysiak J., Sikorski K., Frydrych I., 2011, „Tekstylne elementy grzewcze z przewodami elektroprowadzącymi, ocena ich właściwości. Tkaninowe elementy grzewcze”. Przegląd Włókienniczy, nr 7-8, str. 51-53, wyd. SIGMA-NOT
- [67] Bartkowiak G. 2010. „Kierunki rozwoju odzieży inteligentnej”. Bezpieczeństwo Pracy - Nauka i Praktyka nr 1, str. 18-22
- [68] CIOP-BIP, OCENA SKUTECZNOŚCI STOSOWANYCH ŚRODKÓW OCHRONY INDYWIDUALNEJ NA TLE NAJNOWSZYCH OSIĄGNIĘĆ NAUKI I TECHNIKI W TYM ZAKRESIE, Informacja przygotowana na posiedzenie Rady Ochrony Pracy przez



Centralny Instytut Ochrony Pracy – Państwowy Instytut Badawczy, Warszawa, marzec 2009 r.

- [69] <http://4outdoor.pl/2011/10/11/columbia-sportswear-przedstawia-technologie%c4%99-omni-heat-electric/>
- [70] [https://www.decathlon.pl/kurtka-forclaz-electro-warm-id\\_8234305.html](https://www.decathlon.pl/kurtka-forclaz-electro-warm-id_8234305.html)
- [71] Walczak S., Prezentacja: Tekstronika-i-materialy-nowej-generacji-wyzwanie-dla-producentow-odziezy-sylwia-walczak-cbi-pro-akademia.html
- [72] Mather R.R., 27-28.11.2000, Intelligent textiles a survey of actual developments, International Symposium Avantex, Frankfurt am Main
- [73] Sławomir Wiak, 2010, Systemy tekstroniczne w mechatronice, red. S. Wiak. Mechatronika, tom 2, rozdział 10, Łódź
- [74] Informacja przygotowana na posiedzenie Rady Ochrony Pracy przez Centralny Instytut Ochrony Pracy – Państwowy Instytut Badawczy, Warszawa, marzec 2009r.: [http://rop.sejm.gov.pl/1\\_0ld/opracowania/pdf/material6.pdf](http://rop.sejm.gov.pl/1_0ld/opracowania/pdf/material6.pdf)
- [75] [http://www.bioenergiadlaregionu.eu/gfx/baza\\_wiedzy/101/walczak1.pdf](http://www.bioenergiadlaregionu.eu/gfx/baza_wiedzy/101/walczak1.pdf)
- [76] <http://www.dailymail.co.uk/sciencetech/article-2568672/Forget-wristbands-smart-T-SHIRT-GPS-sensors-monitor-heart-rate-running-speed-woven-it.html>
- [77] Szmyszal J., Furman J., Kaczmarczyk G., Analiza możliwości wykorzystania systemu RFID (Radio Frequency Identification) w usprawnieniu zarządzania wybranym magazynem przemysłowym
- [78] Xiaowei Zhu, Samar K. Mukhopadhyay, Hisashi Kurata, 2012, A review of RFID technology and its managerial applications in different industries, Journals Elsevier, Volume 29, Issue 1, January 2012, Pages 152-167
- [79] [www.fresh222.us/rfid.php](http://www.fresh222.us/rfid.php)
- [80] <http://www.katdziew.p.lodz.pl/katdziew2/referatypdf/INTELIGENTNE.pdf>
- [81] <http://www.geenfc.com/en/Products/UHFTags/rfidgarmenttag/2015-01-03/179.html>
- [82] <http://www.tevone.com/research-news/226-printed-rfid-tags-on-the-horizon>
- [83] <http://hadatap.pl/>
- [84] <http://www.axrfid.com/>
- [85] Sylwia Walczak, Tekstronika, [http://www.bioenergiadlaregionu.eu/gfx/baza\\_wiedzy/101/walczak1.pdf](http://www.bioenergiadlaregionu.eu/gfx/baza_wiedzy/101/walczak1.pdf)
- [86] <http://newatlas.com/go/2522/>

- [87] Materiał Smart Sensing – ubieralne technologie w odzieży sportowej, 4 Lut 2014 Michał Sitnik, <http://tabliczni.pl/2014/02/material-smart-sensing-ubieralne-technologie-w-odziezy-sportowej/>
- [88] CEN/TR 16298:2011 Textiles and textile products. Smart textiles. Definitions, categorisation, applications and standardization needs
- [89] EN 50110-1:2014 Operation of electrical installations - Part 1: General requirements
- [90] EN 13921:2007 Personal protective equipment. Ergonomic principles
- [91] EN 60335-1:2012+A13:2017 Household and similar electrical appliances. Safety. General requirements
- [92] EN 60335-2-29:2004+A11:2018 Household and similar electrical appliances. Safety. Particular requirements for battery chargers
- [93] EN 60086-4:2015 Primary batteries. Safety of lithium batteries
- [94] EN 62133-2:2017 Secondary cells and batteries containing alkaline or other non-acid electrolytes – Safety requirements for portable sealed secondary cells, and for batteries made from them, for use in portable applications. Lithium systems
- [95] The European Union Low Voltage Directive 2014/35/EU Low Voltage Guidance. 2014. Source: <https://eur-lex.europa.eu/legal-content/EN/TXT/?uri=CELEX:32014L0035>
- [96] Hanuska, A., Chandramohan, B., et al. Smart Clothing Market Analysis. [online] California: University of Berkeley, 2016. Available from: <https://scet.berkeley.edu/wp-content/uploads/Smart-Clothing-Market-Analysis-Report.pdf>
- [97] Dias, T. Electronic Textiles. Smart Fabrics and Wearable Technology. Cambridge: Elsevier Science & Technology, 2015. 156 p. ISBN 978-0-08-100201-8
- [98] McCann, J., Bryson, D. Smart Clothes and Wearable Technology. Cambridge: Elsevier Science & Technology, 2009. 484 p. ISBN 978-1-84-569357-2
- [99] Newman, A. Rising of smart workwear. [online] 2017. Available from: [https://www.eniday.com/en/human\\_en/clothing-workwear-equipment/](https://www.eniday.com/en/human_en/clothing-workwear-equipment/)
- [100] Eurostat data base. Accidents and injuries at work. Available from: [http://ec.europa.eu/eurostat/statistics-explained/index.php/Accidents\\_and\\_injuries\\_statistics](http://ec.europa.eu/eurostat/statistics-explained/index.php/Accidents_and_injuries_statistics)
- [101] Mukhopadhyay, S.C. Wearable Electronics Sensors: For Safe and Healthy Living. Cham: Springer International Publishing AG, 2015. 333 p. ISBN 978-3-31-918190-5
- [102] Biodegradable polyesters. 2015. Weinheim: John Wiley & Sons, Incorporated; <http://ebookcentral.proquest.com/lib/cop-ebooks/detail.action?docID=1964209>

- [103] Grimmelsmann, N., Martens, Y., Schäl, P., Meissner, H., & Ehrmann, A. 2016. Mechanical and electrical contacting of electronic components on textiles by 3D printing doi://doi.org/10.1016/j.protcy.2016.08.010
- [104] Multi3D. 2016. Electrifi FAQ. Retrieved from <https://www.multi3dllc.com/faqs>. Accessed: 1 Dec 2017
- [105] Blackmagic3D. Conductive graphene PLA filament 100g. Retrieved from <http://www.blackmagic3d.com/Conductive-p/grphn-pla.htm>. Accessed: 1 Dec 2017
- [106] Wijk Av. 2015. 3d printing with biomaterials: Towards a sustainable and circular economy. The Netherlands: IOS Press / Delf University Press: 85 pages. <https://centria.finna.fi/Record/colibri.72722> or <http://ulib.iupui.edu/static/pdfs/3DPrintingBiomaterials.pdf>
- [107] ISO 11339:2010 Adhesives - T-peel test for flexible-to-flexible bonded assemblies
- [108] Hashemi Sanatgar R, Campagne C, Nierstrasz V. 2017. Investigation of the adhesion properties of direct 3D printing of polymers and nanocomposites on textiles: Effect of FDM printing process parameters. Applied Surface Science. 403(Supplement C):551-563. <http://www.sciencedirect.com/science/article/pii/S0169433217301137>. doi: //doi.org/10.1016/j.apsusc.2017.01.112
- [109] ISO 7854:1995 Rubber- or plastics-coated fabrics - Determination of resistance to damage by flexing
- [110] ISO 15797:2017 Textiles - Industrial washing and finishing procedures for testing of workwear
- [111] Mitutoyo.com. (2018). [online] Available at: [https://www.mitutoyo.com/wp-content/uploads/2012/11/1984\\_Surf\\_Roughness\\_PG.pdf](https://www.mitutoyo.com/wp-content/uploads/2012/11/1984_Surf_Roughness_PG.pdf)
- [112] Standard: ISO 62:2008 Plastics. Determination of water absorption.
- [113] Carrol, T. R. (2001). *Chemical protective clothing*. Occupational Health & Safety, 70 (8), 36-46
- [114] Simon, Y. L. (2010). *The effect of personal protective equipment Level A suits on human task performance*. Master thesis 4994, Curtis Laws Wilson library; Missouri University of Science and Technology, p. 65.
- [115] Kenar, L., Karayilanoglu, T. (2004). *Prehospital management and medical intervention after a chemical attack*. Emergency Medicine Journal, 21 (1), 84-88.
- [116] Bensel, C. K. ,Teixeira, R. A., and Kaplan, D. B. (1987). *The effects of US army chemical protective clothing on speech intelligibility, visual field, body mobility and*

*psychomotor coordination of men.* Army Natick Research Development and Engineering Centre.

- [117] Bansel, C. K. (1997). *Solder performance and functionality: impact of protective chemical clothing.* Military Psychology, 9 (4), 287-300.
- [118] Headley, D. B., Hudgens, G. A. (1997). *The impact of chemical protective clothing on military operational performance.* Military Psychology, 9 (4), 359-374.
- [119] Krueger, G. (2001). *Psychological and performance effects of chemical-biological protective clothing and equipment.* Military Medicine, 166 (2), 41-43.
- [120] Adams, P. S., Slocum, A. C., Keyserling, W. M. (1994). *A model for protective clothing effects on performance.* International Journal of Clothing Science and Technology, 6, (4), 6-16.
- [121] Belmonte, R. B. (1998). *Tests of level A suits – protection against chemical and biological warfare agents and simulants: executive Summary.* Springfield, V.A: National Technical Information Service.
- [122] Hancock, P. A. ,Vasmatzidis, I. (2003). *Effects of heat stress on cognitive performance: the current state of knowledge.* International Journal of Hyperthermia, 19 (3), 355-372.
- [123] Pilcher, J., Nadler, E., Busch, C. (2002). *Effects of hot and cold temperature exposure on performance: a meta –analytic review.* Ergonomics, 45 (10), 682-698.
- [124] Raheel , M. (1994). *Protective Systems and Materials,* Marcel Dekker Inc., New York.
- [125] Khalil, E. (2015). *A technical overview on protective clothing against chemical hazards.* AASCIT Journal of Chemistry, 2 (3), 67-76.
- [126] Forsberg, K., Borre, A., Henry, N., Zeigler , J. P. (2014). *Quick selection guide to chemical protective clothing.* 6th edition. John Wiley & Sons, Inc., New York.
- [127] Truong, Q. (1999). *Test and evaluation of selectively permeable materials for chemical/biological protective clothing.* Master thesis. University of Massachusetts Lowell, Lowell Massachusetts.
- [128] Wely, E. (2017). *Current global standards for chemical protective clothing: how to choose the right protection for the right job?* Industrial Health, 55 (6), 485-499.
- [129] Scott, R. A. (ed.) (2005). *Textiles for protection.* Elsevier, Amsterdam.
- [130] <http://www.hse.gov.uk/chip/phrases.htm> (HSE / Guidance / Topics/ Chemical classification / Labelling and packaging).

- [131] <http://www.ansell.com/en/Products/Protective-Clothing/Chemical-Protective-Suits/trellchem-vps> (Ansell company).
- [132] <http://www.ansell.com/en/Products/Protective-Clothing/Chemical-Protective-Suits/trellchem-vps> Chemical protective suits. User manual. EVO/VPS-Flash/VPS/Super/Light.
- [133] <https://www.urbantool.com/en/> (Urban Tool company)
- [134] [https://www.draeger.com/en\\_seeur/Home](https://www.draeger.com/en_seeur/Home) (Drager company)
- [135] <https://www.savox.com/products> (Savox company)
- [136] HC-1 helmet-com® unit bone-mic/single speaker <http://www.novelradio.it/wp-content/uploads/sites/6/2015/04/SAVOX-HC-1-Novelradio.pdf>
- [137] <https://mydevices.com/> (Finished IoT Solutions)

## ANNEXES

### ANNEX 1

#### Software programing code of transmitter:

```
#include <RF24.h>
#include <SPI.h>
#include <RF24V.h>
RF24 radio(7,8);
RF24V Sound(radio,0);
void setup() {
  radio.begin();
  radio.setChannel(0x4b);
radio.setDataRate(RF24_250KBPS); //250KBPS, 1MBPS, 2MBPS
  Sound.begin();
  Sound.transfer();}
void loop() {}
```

#### Software programing code of receiver:

```
#include <RF24.h>
#include <SPI.h>
#include <RF24V.h>
RF24 radio(7,8);
RF24V Sound(radio,0);
void setup() {
  radio.begin();
  radio.setChannel(0x4b);
radio.setDataRate(RF24_250KBPS); //250KBPS, 1MBPS, 2MBPS
  Sound.begin();
  Sound.reader();}
void loop() {}
```

### ANNEX 2

#### Software programing code of smart vests main controller with sensors:

```
#include <CayenneMQTTESP8266.h>
#include <OneWire.h>
#include <DallasTemperature.h>
#include <Wire.h>
#include <SPI.h>
#include <Adafruit_Sensor.h>
#include <Adafruit_BMP280.h>
#include <DHT.h>

#define CAYENNE_DEBUG
```

```

#define CAYENNE_PRINT Serial

#define temp_vidus 0

#define temp_isore 2

#define BMP_SCK 5

#define BMP_SDI 4

#define BMP_SCL 12

#define BMP_SDA 13

#define DHTPIN 14

#define DHTTYPE DHT22

int analogPin=0;
int val = 0;
int BPM;
int BMP280readPressure = 1;
int MPU6050_Gx=1;
//int itampa=A0;
//int ireiksme;

/*const uint8_t MPU6050SlaveAddress = 0x68;
const uint8_t scl = D6;
const uint8_t sda = D7;
const uint16_t AccelScaleFactor = 16384;
const uint16_t GyroScaleFactor = 131;
const uint8_t MPU6050_REGISTER_SMPLRT_DIV = 0x19;
const uint8_t MPU6050_REGISTER_USER_CTRL = 0x6A;
const uint8_t MPU6050_REGISTER_PWR_MGMT_1 = 0x6B;
const uint8_t MPU6050_REGISTER_PWR_MGMT_2 = 0x6C;
const uint8_t MPU6050_REGISTER_CONFIG = 0x1A;
const uint8_t MPU6050_REGISTER_GYRO_CONFIG = 0x1B;
const uint8_t MPU6050_REGISTER_ACCEL_CONFIG = 0x1C;
const uint8_t MPU6050_REGISTER_FIFO_EN = 0x23;
const uint8_t MPU6050_REGISTER_INT_ENABLE = 0x38;
const uint8_t MPU6050_REGISTER_ACCEL_XOUT_H = 0x3B;
const uint8_t MPU6050_REGISTER_SIGNAL_PATH_RESET = 0x68;
int16_t AccelX, AccelY, AccelZ, Temperature, GyroX, GyroY, GyroZ;
*/
#define USE_ARDUINO_INTERRUPTS true
DHT dht(DHTPIN, DHTTYPE);

//Adafruit_BMP280 bme;

```

```

        OneWire temp_viduss(temp_vidus);
        OneWire temp_isoree(temp_isore);
        DallasTemperature vidus(&temp_viduss);
        DallasTemperature isore(&temp_isoree);

        char ssid[]= "projektas";
        char password[]= "projektas2018";

        char username[]= "1f37b0f0-875a-11e8-890a-c1153a0b021e";
        char mqtt_password[]= "7de7ea115343d068fe913ef28e8eb9c7b60a807d";
        char client_id[]= "57bef960-875a-11e8-92bf-4fb683d37678";

        void setup(){
            /*
            Serial.begin(9600);
            Wire.begin(sda, scl);
            MPU6050_Init(); */

        Cayenne.begin(username, mqtt_password, client_id, ssid, password);
            //pinMode(2, OUTPUT);
            //digitalWrite(2, HIGH);
            vidus.begin();
            isore.begin();
            //bme.begin();

            dht.begin();

            float slegis= BMP280readPressure;
            }

        void loop(){

            Cayenne.loop();
            vidus.requestTemperatures();
            isore.requestTemperatures();

            float vidus1= vidus.getTempCByIndex(0);

            float isore1= isore.getTempCByIndex(0);

            float judd= MPU6050_Gx;
            float h= dht.readHumidity();
            float pres=random (1100, 1300);
            int jud=random (0,2);
            val=analogRead(analogPin);
            if (val<=450){
                BPM=20;
            }
            else if (val>452 && val<=500){

```



```

        BPM=76;
    }
    else if (val>501 && val<=512){
        BPM=81;
    }
    else if (val>513 && val<=525){
        BPM=83;
    }
    else if (val>526 && val<=531)
    {
        BPM=84;
    }
    else if (val>532 && val<=534)
    {
        BPM=85;
    }
    else if (val>532 && val<=535){
        BPM=87;
    }
    else if (val>536 && val<=538){
        BPM=88;
    }
    else if (val>538 && val<=540){
        BPM=89;
    }
    else if (val>541 && val<=546){
        BPM=92;
    }
    else if (val>546 && val<=560){
        BPM=93;
    }
    else if (val>561 && val<=580){
        BPM=94;
    }
    else if (val>581 && val<=600){
        BPM=96;
    }
    else{
        BPM=200;
    }
    //ireiksme= analogRead(itampa);

```

```

Cayenne.virtualWrite(1, vidus1, TYPE_TEMPERATURE, UNIT_CELSIUS);
Cayenne.virtualWrite(2, isore1, TYPE_TEMPERATURE, UNIT_CELSIUS);
    Cayenne.virtualWrite(3, pres, TYPE_TEMPERATURE, UNIT_PASCAL);
    Cayenne.virtualWrite(4, h, TYPE_TEMPERATURE, UNIT_PERCENT);
    Cayenne.virtualWrite(5, jud, TYPE_TEMPERATURE, UNIT_PERCENT);
Cayenne.virtualWrite(6, BPM, TYPE_TEMPERATURE, UNIT_PERCENT);

```

```

    }
    /*
void I2C_Write(uint8_t deviceAddress, uint8_t regAddress, uint8_t data){
    Wire.beginTransmission(deviceAddress);
    Wire.write(regAddress);
    Wire.write(data);
    Wire.endTransmission();
}

void Read_RawValue(uint8_t deviceAddress, uint8_t regAddress){
    Wire.beginTransmission(deviceAddress);
    Wire.write(regAddress);
    Wire.endTransmission();
    Wire.requestFrom(deviceAddress, (uint8_t)14);
    GyroX = (((int16_t)Wire.read())<<8) | Wire.read();
}

void MPU6050_Init(){
    //delay(150);
    I2C_Write(MPU6050SlaveAddress, MPU6050_REGISTER_SMPLRT_DIV, 0x07);
    I2C_Write(MPU6050SlaveAddress, MPU6050_REGISTER_PWR_MGMT_1, 0x01);
    I2C_Write(MPU6050SlaveAddress, MPU6050_REGISTER_PWR_MGMT_2, 0x00);
    I2C_Write(MPU6050SlaveAddress, MPU6050_REGISTER_CONFIG, 0x00);
    I2C_Write(MPU6050SlaveAddress, MPU6050_REGISTER_GYRO_CONFIG,
    0x00);//set +/-250 degree/second full scale
    I2C_Write(MPU6050SlaveAddress, MPU6050_REGISTER_ACCEL_CONFIG,
    0x00);// set +/- 2g full scale
    I2C_Write(MPU6050SlaveAddress, MPU6050_REGISTER_FIFO_EN, 0x00);
    I2C_Write(MPU6050SlaveAddress, MPU6050_REGISTER_INT_ENABLE, 0x01);
    I2C_Write(MPU6050SlaveAddress,
    MPU6050_REGISTER_SIGNAL_PATH_RESET, 0x00);
    I2C_Write(MPU6050SlaveAddress, MPU6050_REGISTER_USER_CTRL, 0x00);
}
*/

```

### ANNEX 3

#### **Software programing code of remote surface temperature control unit:**

```

#include "pfodIRTemp.h"
pfodIRTemp irTemp;
int raud=9;
int zalia=6;
int mel=5;
bool fahrenheit = false;
void setup() {
    Serial.begin(9600);

```

```

        pinMode(raud, OUTPUT);
        pinMode(zalia, OUTPUT);
        pinMode(mel, OUTPUT);
    }

    void loop() {
        irTemp.triggerSensor();
        int reading = irTemp.getIRTemperature();
        if (reading != pfodIRTemp::NO_DATA) {
            Serial.print(millis()/1000.0);
            Serial.print(F(",Sec,"));
            if (reading < pfodIRTemp::NO_DATA) {
                Serial.println(F(" ,Invalid Reading"));
            } else {
                if (fahrenheit) {
                    Serial.print(irTemp.convertToFahrenheit(reading));
                    Serial.println(F(",F"));
                } else {
                    Serial.print(irTemp.convertToCelsius(reading));
                    Serial.println(F(",C"));

                    if(irTemp.convertToCelsius(reading)>35){
                        digitalWrite(raud, HIGH);
                        digitalWrite(zalia, LOW);
                        digitalWrite(mel, LOW);
                    }
                    else if
(irTemp.convertToCelsius(reading)<34.9&&irTemp.convertToCelsius(reading)>18){
                        digitalWrite(raud, LOW);
                        digitalWrite(zalia, HIGH);
                        digitalWrite(mel, LOW);
                    }
                    else if (irTemp.convertToCelsius(reading)<17.9){
                        digitalWrite(raud, LOW);
                        digitalWrite(zalia, LOW);
                        digitalWrite(mel, HIGH);
                    }
                }
            }
        }
    }

```

#### Annex 4

#### NodeMCU V3 LUA WiFi (ESP8266)

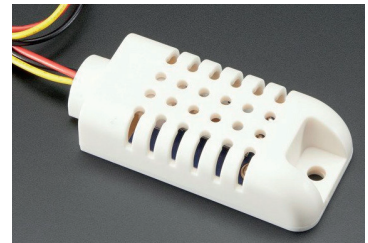


The basis of the smart vest is NodeMCU (single-board microcontroller) - an open source IoT platform operating system XTOS. The Development Kit based on ESP8266, integrates GPIO, PWM, IIC, 1-Wire and ADC all in one board. NodeMCU is an eLua based firmware for the ESP8266 WiFi SOC from Espressif. The controller clock frequency of 80 MHz, has a flash memory of 4 MB of RAM and 128KB. The NodeMCU *firmware* is a companion project to the popular NodeMCU dev kits, ready-made open source development boards with ESP8266-12E chips. The board can be programmed from the Arduino environment, and various attachments can be connected.

Technical specifications:

- Wi-Fi Module – ESP-12E module similar to ESP-12 module but with 6 extra GPIOs.
- USB – micro USB port for power, programming and debugging
- Headers – 2x 2.54mm 15-pin header with access to 10 GPIOs, SPI, I2C, UART, ADC, and power pins
- Misc – Reset and Flash buttons
- Power – 5V via micro USB port
- Dimensions – 49 x 24.5 x 13mm

### **Humidity sensor AM2301 (DHT21)**



The AM2301 is a wired version of the DHT21, in a large plastic body. It is a basic, low-cost digital temperature and humidity sensor. It uses a capacitive humidity sensor and a thermistor to measure the surrounding air, and spits out a digital signal on the data pin (no analog input pins needed). It is fairly simple to use, but requires careful timing to grab data. The only real downside of this sensor is you can only get new data from it once every 2 seconds. The DHT sensors are made of two parts, a capacitive humidity sensor and a thermistor. There is also a very basic chip inside that does some analog to digital conversion and spits out a digital signal with the temperature and humidity. The digital signal is fairly easy to read using any microcontroller.

DHT22 technical specifications:

- Low cost
- 3 to 5V power and I/O

- 2.5mA max current use during conversion (while requesting data)
- Good for 0-100% humidity readings with 3% accuracy
- Good for -40 to 80°C temperature readings  $\pm 0.5^\circ\text{C}$  accuracy
- No more than 0.5 Hz sampling rate (once every 2 seconds)
- Body size 27mm x 59mm x 13.5mm
- 3 wires 23cm long
- 27mm wide x 58.75mm tall x 13.30mm deep

### Temperature sensor Dallas DS18B20



This is a pre-wired and waterproofed version of the DS18B20 sensor made with a PTFE wire cable. Handy for when you need to measure something far away, or in wet conditions because this one can be used up to  $125^\circ\text{C}$  - the limit of the sensor itself. Because the sensor signal is digital, you don't get any signal degradation even over long distances. These 1-wire digital temperature sensors are fairly precise ( $\pm 0.5^\circ\text{C}$  over much of the range) and can give up to 12 bits of precision from the onboard digital-to-analog converter. They work great with any microcontroller using a single digital pin, and you can even connect multiple ones to the same pin, each one has a unique 64-bit ID burned in at the factory to differentiate them. Usable with 3.0-5.0V systems.

DS18B20 technical specification:

- Usable temperature range:  $-55$  to  $125^\circ\text{C}$
- 9 to 12 bit selectable resolution
- Uses 1-Wire interface- requires only one digital pin for communication
- Unique 64 bit ID burned into chip
- Multiple sensors can share one pin
- $\pm 0.5^\circ\text{C}$  accuracy from  $-10^\circ\text{C}$  to  $+85^\circ\text{C}$
- Temperature-limit alarm system
- Query time is less than 750ms
- Usable with 3.0V to 5.5V power/data

### Pulse Sensor

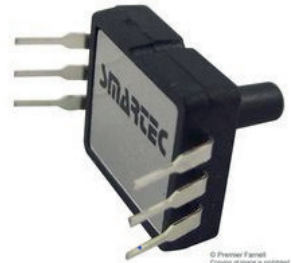
Pulse Sensor is a greatly improved version of the original Pulse Sensor ,heart-rate sensor. Pulse Sensor is a well-designed plug-and-play heart-rate sensor for microcotroller. It also includes an open-source monitoring app that graphs your pulse in real time. It essentially combines a simple optical heart rate sensor with amplification and noise cancellation circuitry making it fast and easy to get reliable pulse readings. Also, it sips power with just 4mA current draw at 5V so it's great for mobile applications.

Technical specifications:

- Diameter = 0.625" (~16mm)
- Overall thickness = 0.125" (~3mm)

- Working Voltage = 3V to 5V
- Working Current = ~4mA at 5V

### Smartec SPD005G pressure sensor



The Smart Pressure Device SPD series of pressure sensors are silicon based and encapsulated in modified plastic Dual In Line packages, to accommodate six pins for through-board printed circuit mounting.

The sensors come in two distinct types: Gauge and absolute. The gauge type merely measures the pressure with respect to the atmospheric pressure. The absolute type contains a reference vacuum chamber, which is formed on the die during manufacturing. The pressure range can vary between about 10 mBar and 0,35 Bar gauge (SPD005G), absolute and differential. In case of the absolute version, the reference vacuum chamber is formed on the die during manufacturing. The Smartec Pressure Devices are based on the principle that pressure in a liquid or gas will bend a membrane. This membrane has a very thin conductive screened layer that bends with the membrane. The resistance of the conductive layers will change as the membrane bends. This bending is measured by means of a Wheatstone bridge. In general the screened resistors are also sensitive to temperature which means a compensation for temperature effects is required. The internal amplifier includes temperature compensation to provide a stable analogue output. Smartec pressure sensors have a wide range of outputs including bridge, analogue, digital and I2C output.

Technical specifications:

- Pressure type: gauge
- Pressure measurement range: 0...35 kPa
- Accuracy  $\pm 0.3\%$
- Output voltage 140 mV
- Power 5...10V
- working temperature -20...+85 °C

## SMART CLOTHING

– Report of laboratory tests of smart clothing technologies and materials

In order to ensure special protection for a working-man against various types of risks that may occur during performance of the job/task, workwear sets and footwear are provided. Nowadays, tasks of the PPE include protection against environmental and manmade hazards, provision of comfort and preservation of human performance ability and life over a long period of time. The main trends in the design of workwear cover physiological monitoring, cold and heat protection, monitoring of chemical and biological protection, fire protection and protection against external environment hazards, as well as protection against various types of weapons. PPE must meet the requirements of the European Standards, the Cabinet Regulations and requirements of the respective company. Describing the specifics of workwear design, the following key factors in designing clothing systems can be addressed: protection, comfort, mobility (or ergonomics), connectivity (or compatibility) and ease of use (or functionality).

Centria. Raportteja ja selvityksiä, 36  
ISBN 978-952-7173-39-8 (PDF)  
ISSN 2342-933X