

Automation System Products and Research



Automation System Products and Research

Mikko Rintala • Jussi Sormunen • Petri Kuisma • Matti Rahkala

Automation System Products and Research

Publication series B. Reports 12/2014

Lapland University of Applied Sciences
Rovaniemi 2014

© Lapland UAS and authors

ISBN 978-952-316-026-2 (pdf)
ISSN 2342-2491 (Electronic Publication))

Publications of Lapland UAS
Publication series B. Reports 12/2014

Authors: Mikko Rintala, Jussi Sormunen,
Petri Kuisma & Matti Rahkala
Layout: Lapland UAS

Lapland University of Applied Sciences
Jokiväylä 11 C
96300 Rovaniemi, Finland

Tel. +358 20 798 6000
www.lapinamk.fi/julkaisut



The Lapland University Consortium is a unique form of strategic alliance in Finland, as it composes a union between University and University of Applied Sciences.
www.luc.fi

Content

1 INTRODUCTION	7
2 AUTOMATION SYSTEM PRODUCTS	9
2.1 Ouman	9
2.2 EBTS	15
2.3 Fidelix	17
2.4 Carlo Cavazzi Oy Ab	19
2.5 Talomat	21
2.6 Schneider Electric	24
2.7 Honeywell	26
2.8 Delta Controls	27
2.9 Beckhoff	29
2.10 Siemens	31
3 AUTOMATION BUSES	33
4 WHAT IS IN RESEARCH PHASE?	35
5 BUILDING TECHNOLOGY	43
5.1 Sensors used in measurements in building technology	43
6 HEATING	49
6.1 Need for heating	49
6.2 Heating control	52
6.2.1 Outdoor temperature sensor placement	56
6.2.2 Room temperature sensor placement	57
6.3 Heat distribution systems	57
6.3.1 Water radiator heating	57
6.3.2 Hydronic radiant floor heating	58
6.3.3 Air heating systems	59
6.3.4 Direct electric heating	59

6.4 Heating systems for SFHs (Single Family Houses)	60
6.4.1 Primary heating systems	61
6.4.2 Secondary heating systems	71
7 VENTILATION AND AIR CONDITIONING	73
7.1 Ventilation systems	74
7.1.1 Balanced ventilation	74
7.1.2 Ventilation unit	75
8 PILOT HOUSE DESCRIPTION IN LEVI, FINLAND	79
8.1 Abstract	79
8.2 Description of low energy house	79
8.3 Work packages	81
8.4 Summary	87
9 UNIFICATION OF HOME AUTOMATION AND BUILDING TECHNOLOGY	89
9.1 What is the challenge and what is available	89
9.2 What is available	89
9.3 Compatibility challenge	89
10 SOURCES	91

1 Introduction

Automation systems are used in most buildings nowadays. In the past they were mainly used in industry to control and monitor critical systems. During the past few decades the automation systems have become more common and are used today from big industrial solutions to homes of private customers. With the growing need for ecologic and cost-efficient management systems, home and building automation systems are becoming a standard way of controlling lighting, ventilation, heating etc.

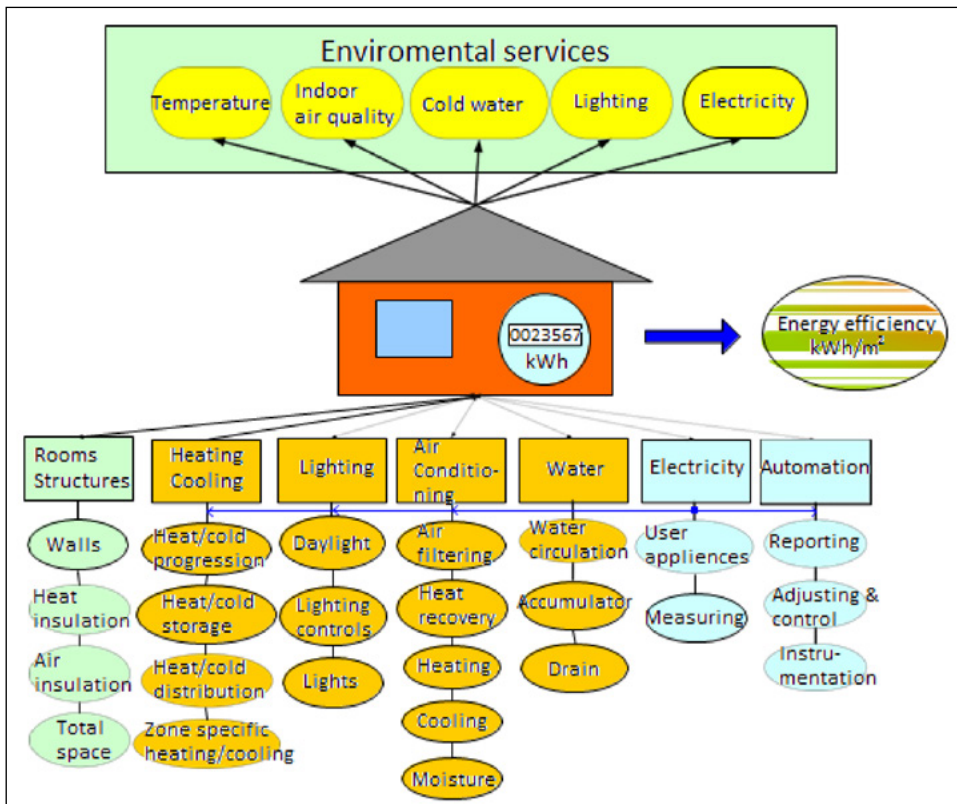

Picture 1. Elements of energy efficiency and indoor air-quality

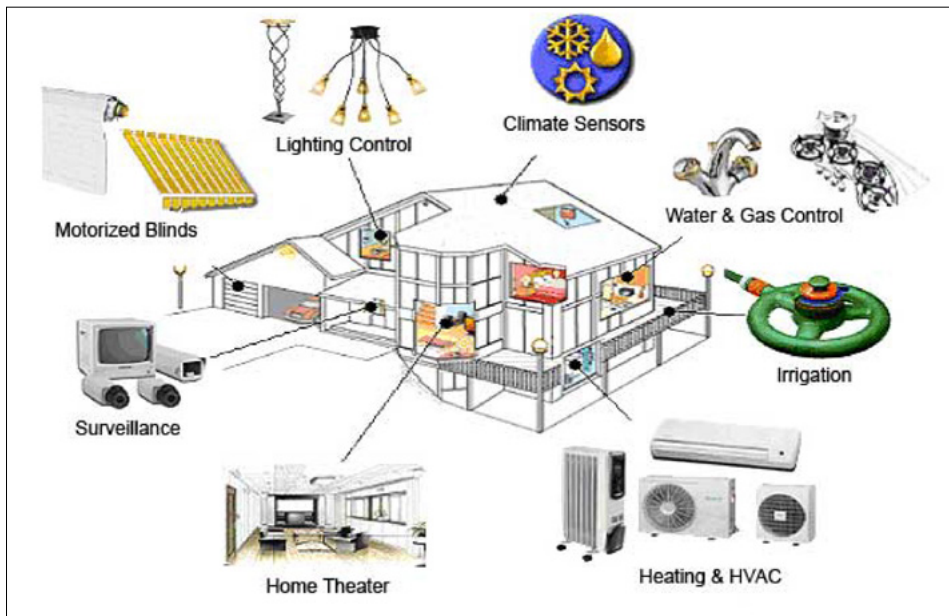

Picture 2. Example of home automation system functions

Automation of houses and other buildings vary between countries even though some products are more widely used. There is a need to map the state-of-the-art of those available in the market, and to explore what type of research results has been published in the recent years to get an implication what type of products will be coming into the market in near future.

Other automation sectors – especially the industry automation – is highly developed. Thus benchmarking between building and industrial automation is needed regarding both the existing systems and standardization even though there are specialized buses for building sector.

There is also a need to explore current state of building technology. Are there possibilities to develop cooperation between automation providers and building technology manufacturers. Is building technology progress for single family houses on the same level than automation system progress.

2 Automation System Products

In this part of this report the automation systems on the market today are presented by their general information as well as with their main connections and functions. The different sized systems are listed to represent many different application possibilities available.

2.1 OUMAN

OUMAN PLUS

/1/ System in general:

Ouman Plus is a new, easy-to-use home automation system which automatically reacts to different situations in your home. Ouman Plus combines heating, ventilation, security systems and other building automation controls and settings into one unit. The system conserves energy and provides a higher level of comfort and security. It features heating and ventilation control, security monitoring, smart state controls, synchronized supply water controls, GSM remote control and configuration design program. Ouman Plus can be installed during buildings construction phase.

A basic philosophy of Ouman products is that they must be easy to use. The system's design and configuration are considered to be especially important. For this reason, the easy-to-use Plus Tool online design program has been developed to create home automation for the electrical design, a list of devices and their prices, and the necessary connection guide.

Connections:

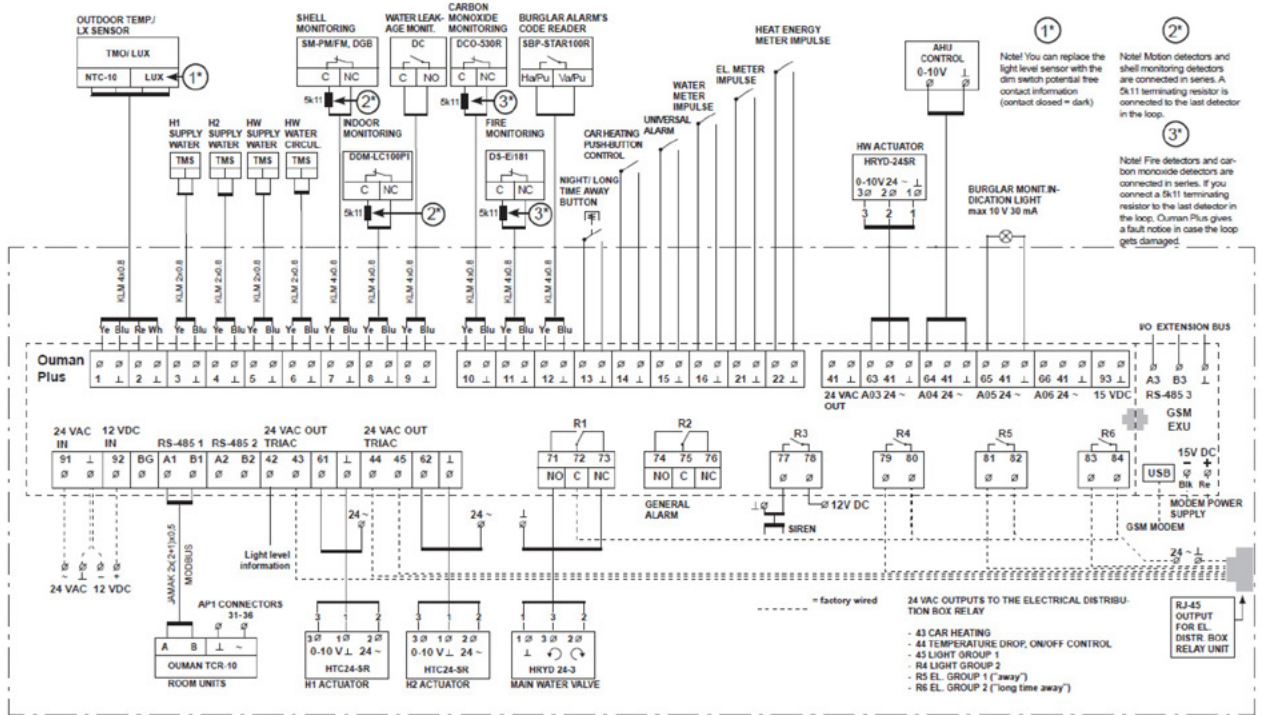

Picture 3: Ouman Plus connections

- 16 universal inputs
- 2 digital inputs
- 5 analog outputs
- 4 triac controls
- 6 relay controls
- 3 RS-485 (Modbus)
- 1 USB host
- 1 Ethernet 10/100 Mbit/s

OUMAN OUFLEX

/2/ System in general:

Ouman Ouflex is a freely programmable automation system which features monitoring, control and adjustment capabilities. Ouflex is a modular system that is easily extendable with three different types of extension modules to fit the needs of the customer. With additional modules the Ouman Ouflex system can be connected to a modem or GSM network. Control panel of the main unit is removable and it can be installed where it's easiest to access. The programming tool allows users to modify existing parameters and to connect new devices to the system. Ouman Ouflex is also compatible with Ouman Ounet internet monitoring tool.

Connections:

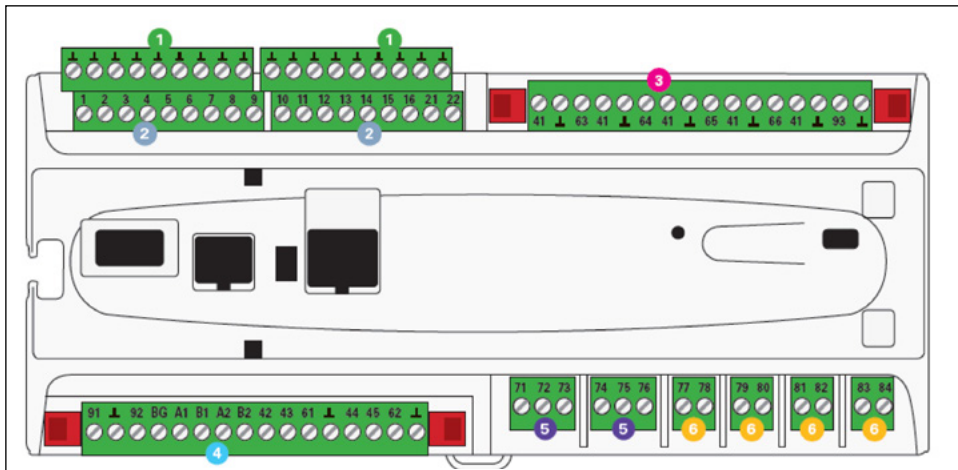

Picture 4. Ouman ouflex connections

- 16 universal inputs
- 3 of which including pulse calculation
- 2 digital inputs including pulse calculation
- 6 analog outputs
- 2 RS-485 (Modbus)
- 2 triac controls
- 6 relay controls
- 1 USB-host for GSMMOD6-modem
- 1 USB-device
- 1 Ethernet 10/100 Mbit/s

/3/ Extension modules:

Flex Combi 32

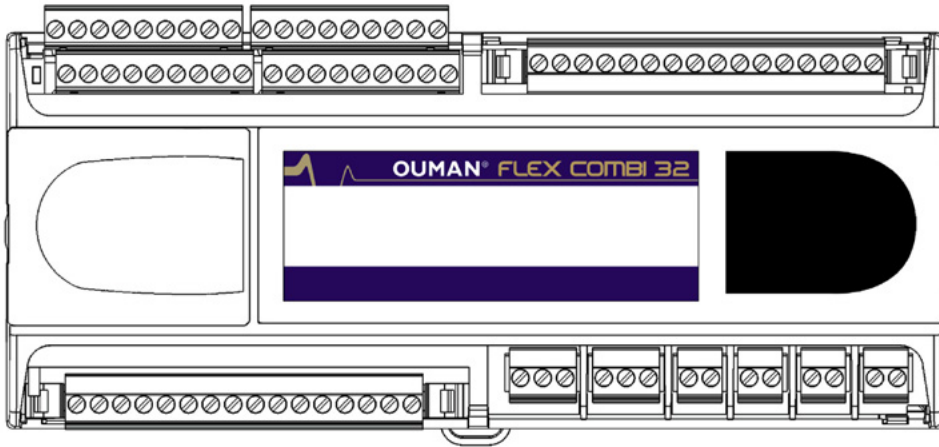

Picture 5. Ouman Flex Combi 32 connections

- 16 Universal inputs
- 6 analog outputs
- 6 relay controls
- 4 triac controls

Flex Combi 21

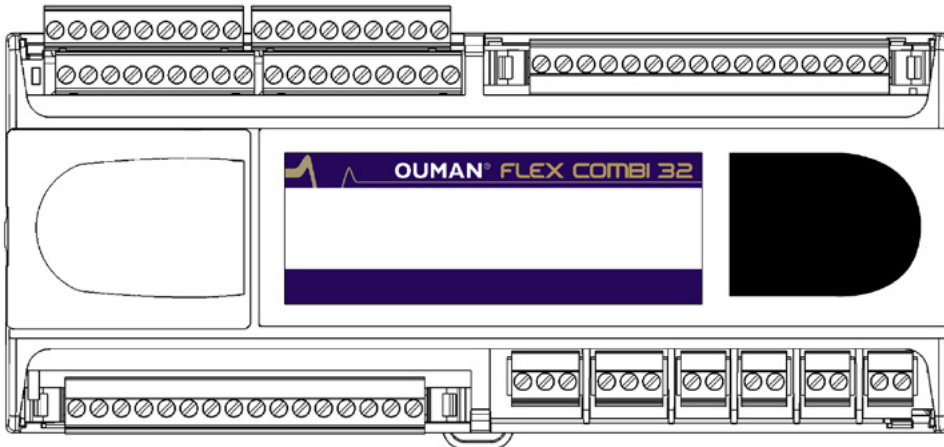

Picture 6. Ouman Flex Combi 21 connections.

Ouman Flex Combi 21 is fitted into same casing as Ouman Flex Combi 32

- 9 universal inputs
- 2 analog outputs
- 6 relay controls
- 4 triac controls

Flex UI-16

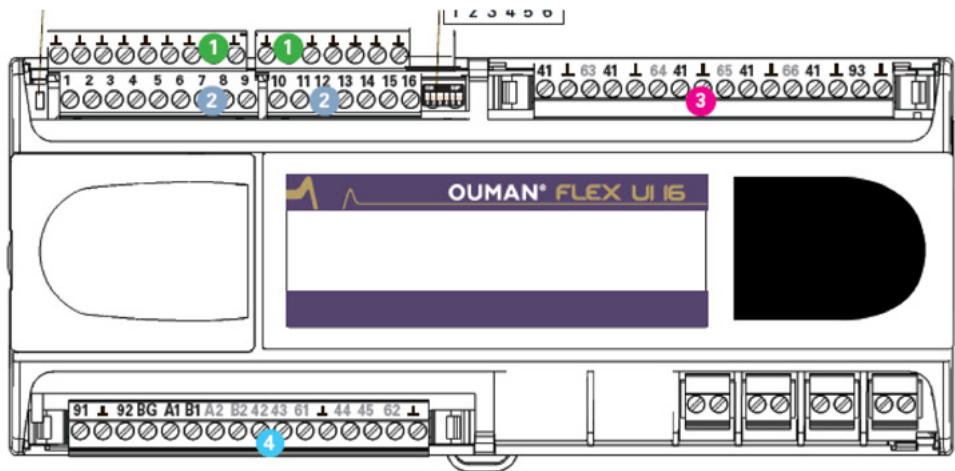

Picture 7. Ouman Flex UI 16 connections

- 16 universal inputs

Flex-EXU

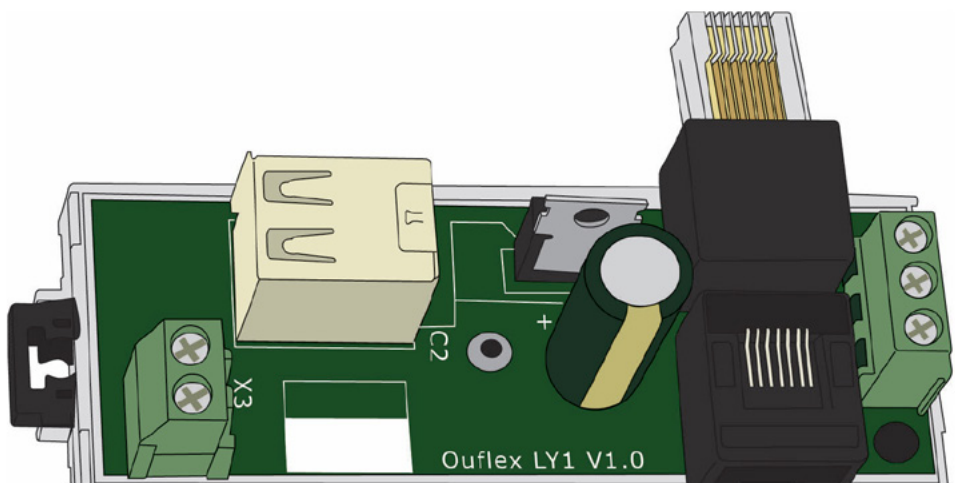

Picture 8. Ouman Flex-EXU

Extension card for modem and I/O extensions

- 1 RS-458 (Modbus)
- 1 USB-host for GSMMOD6-modem

GSMMOD6



Picture 9. Ouman GSMMOD6

- GSM modem module for Ouman automation products

/21/ EH-60

System in general:

Ouman EH-60 system is an intelligent solution for application control and monitoring in small houses. With EH-60 you can remotely control and monitor electrical heating anywhere, at any time. The system also allows you to implement security, fire hazard and water leakage monitoring and also control car heaters, lighting, electric locks etc. EH-60 can also be used to inform the user about power failures. All controls and monitoring can be set to follow a user definable timetable.

Communication with EH-60 is done via GSM text messages. It's also possible to connect EH-60 to EH-net via Modbus. In this case the communication can be also managed with a web browser. Both communication methods can be used simultaneously.

EH-60 can be used with Ouman EH-200 controller to control the heating systems in the house. This allows you to connect all systems in the house to a single automation system.

Connections:

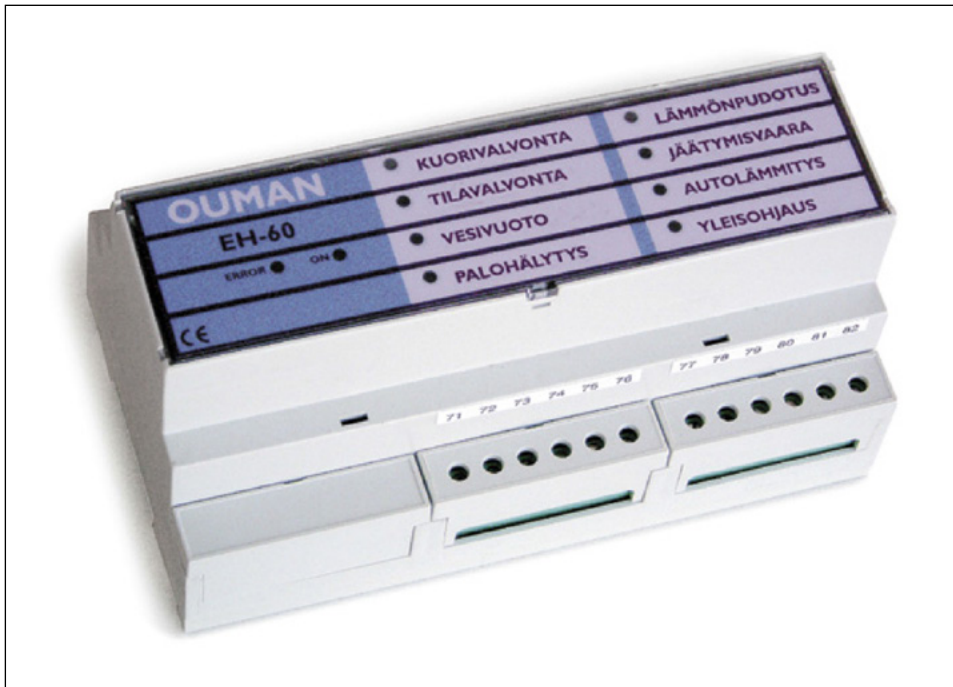

Picture 10. Ouman EH-60

- 8 universal inputs (DI or AI)
- 6 relay controls (230VAC or 24VAC/DC)
- 1 RS-232C
- 1 RS-485

2.2 EBTS

/4/ System in general:

EBTS home automation system is a next generation system, which provides automation, security, measurement, lighting control and building information system in a single package. Browser control enables easy access to the system from anywhere. Focus points and main principals of development in EBTS system were usability, reliability and cost efficiency. Using a single system instead of many also makes it cheaper for the customer.

The security section in the system includes burglar alarm, fire alarm and water leakage monitoring. The sensors used for security section can also be used to control various other applications in the house, like lighting.

Since the systems in EBTS automation system are fully integrated, the fault logs and other variables are possible to be instantly fed into a service manual for later use. The service manual is easily accessible and it helps to keep track of the maintenance schedule for the building.

In the control and adjustment system the house can be divided into different area profiles with individual heating and air conditioning profiles. This helps significantly in lowering the costs of living.

Connections:

MSU-100 measurement unit



Picture 11. MSU-100 measurement unit

- 8 SEN-10X sensor inputs
- 4 pulse inputs
- 6 analog inputs

ADU-100 Adjustment unit



Picture 12. ADU-100 adjustment unit

- 6 analog outputs
- 6 relay controls
- 1 RS-232C
- 1 RS-458

SCU-100 Security unit



Picture 13. SCU-100 security unit

- 12 switch inputs
- 4 12V alarm output
- 6 12V power output for sensors

CTU-100 Control unit



Picture 14. CTU-100 control unit

- 12 24V controlled output
- 12 24V switch inputs

2.3 FIDELIX

/5/ FX-NET

System in general:

Fidelix FX-Net is a freely scalable technical monitoring and control system for buildings of all sizes. FX-Net represents a new generation of systems designed to meet the needs of modern construction and advanced building technology. The FX-Net networked system can be used for several applications such as the controlling of heating, ventilation and/or air conditioning, energy and water consumption measurement, burglar alarms, access control, video surveillance systems and fire security.

Fidelix FX-Net is a building automation system manages many things such as room temperatures, ventilation and lighting according to schedules, user input or occupancy. This way total energy consumption can be efficiently managed. The system also monitors usage and consumption and provides detailed reports to help detect harmful and costly exceptions in daily usage. Comfortable living conditions increase happiness and productivity with better indoor air quality. The automation system takes care of providing the optimal living and working climate.

Efficient maintenance and upkeep Information about faults or exceptions is forwarded to the predefined receivers such as a building attendant, maintenance personnel or other service providers. Remote access to the system makes the job even easier and lowers response times. Centralized monitoring in The FX-Net can forward alarm, fault and usage reports automatically to the correct people. Centralized monitoring makes it possible to manage several sites from one location. Remote access to substations further increases the possibilities to control and monitor all subsystems. Improved security in The FX-Net reacts to abnormalities and alarms quickly and automatically to maximise security. This can for example include stopping pumps, closing valves or activating fire dampers. In addition to reacting the FX-Net system can also take care of scheduled testing of the critical systems. Traditional security features such as access control and intruder monitoring can also be integrated into the same system.

Connections:

FX-40-SPIDER Substation



Picture 15. FX-40-SPIDER Substation

- 16 universal inputs (DI or AI selectable)
- 8 digital inputs
- 8 relay outputs
- 8 analog outputs
- 1 RS-485 (Modbus RTU)

Extension modules:

FX-2025A Substation



Picture 16. FX-2025A Substation

- 2 ethernet connections
- 1 RS-485 (Modbus RTU)

Analogue connection modules, digital connection modules, combination modules and controllers with various inputs and outputs are also available for the Fidelix FX-Net.

2.4 CARLO CAVAZZI OY AB

/6/ SMART-HOUSE

System in general:

Smart-House concept is a tested modern technology based automation system that controls all functions in the house. These functions can include lighting, heating, fire alarms, water leaking and burglar alarms.

Comfortable living, security, monitoring, flexibility, user friendliness and energy efficiency are the basic elements of this intelligent system, which help you to adapt the house to the hopes and needs of the people living there.

Smart-House is based on Dupline-bus technology. This technology was previously only used in industrial systems, but now it has been implemented to the house- and home automation systems. The flexibility of Dupline technology makes the system easy to use in both industrial and house automation applications.

Smart-house is specialised in providing first-rate Home Automation installations. It uses an advanced Windows-CE based controller: communication and automated functions between products are now possible, thanks to this innovative controller, that acts as the heart in smart-house system. Smart-house controller allows to extend the system to 1024 I/O addressed and, thanks to its integrated battery backup function, works as a safe power provider for smart-house components, as light switches, movement detectors and temperature sensors. This controller is provided with a very simple and effective configuration tool: with a 3 step approach, users can easily define smart-house modules to be used in each room, enter descriptive names for each I/O and activate the desired operating parameters, room by room.

Connections:

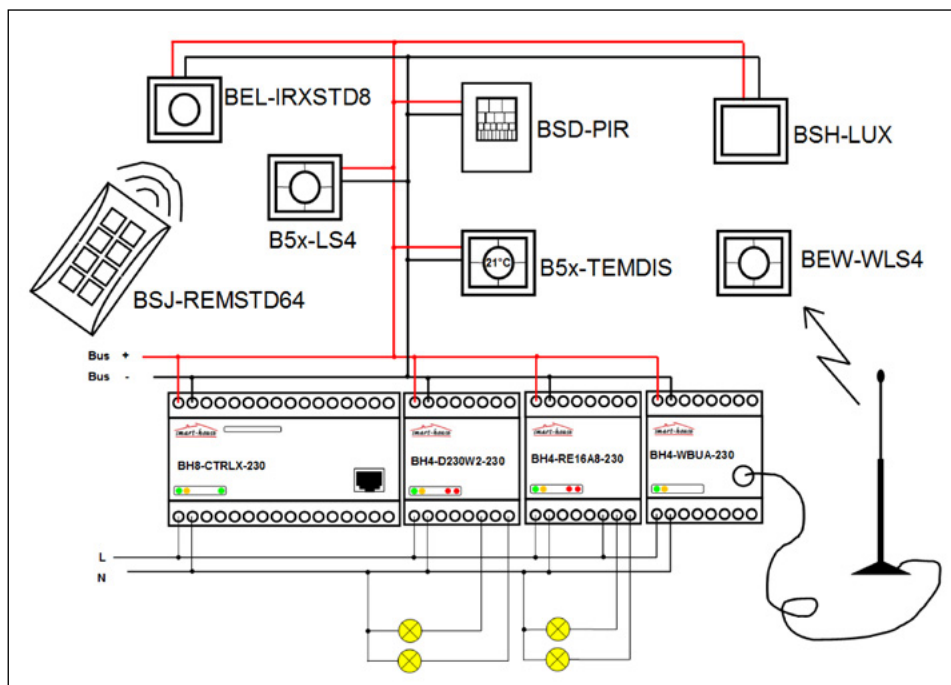

Picture 17. Smart-House system connections

- 256 I/O addresses (128 inputs and 128 outputs)
- Up to 3 extension modules connection, allowing max 1024 addresses
- Ethernet, USB and RS232 communication ports
- GSM extension module connection

2.5 TALOMAT

/7/ SYSTEM IN GENERAL:

Talomat home automation system is made to easily control many different applications in a house making living more comfortable, secure and ecologic. It can be controlled via GSM, PC or a tablet, but lighting can also be adjusted with switches. Talomat automation systems come in three different sized premade packages, but those can easily be extended later. The main focus of the system is intelligent and energy efficient lighting and it is recommended to use led-lights with it.

Talomat systems can be connected to a 12V backup battery, which also enables the user to connect solar power or wind power to the system.

System components:

Node A95 control unit



Picture 18. Talomat Node A95 control unit

- 8 universal inputs (DI or AI selectable)
- 6 analog outputs
- 1 Can-bus
- 1 RS-232

JuCe M95 Junction unit

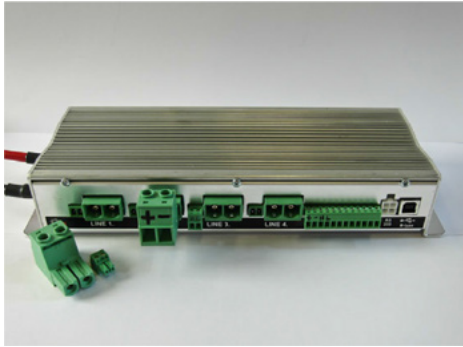

Picture 19. Talomat JuCe M95 junction unit

- 4 data connection pairs
- 4 line connection pairs
- 1 RS-232
- 1 USB B-type
- 1 Can-bus

Talomat switch, 4 switches



Picture 20. Talomat switch, 4 switches

- 4 press-buttons (resistor grid)
- Linkable (2 in a link)
- Adjustable led background lighting

Talomat switch, 2 switches



Picture 21. Talomat switch, 2 switches

- 2 press-buttons (resistor grid)
- Linkable (4 in a link)
- Adjustable led background lighting

Switch connector

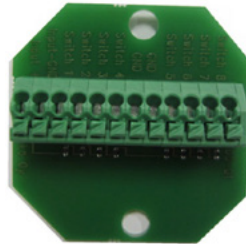

Picture 22. Talomat Switch connector

- Resistor-grid based operation
- 8 switch connections
(switch must be spring operated)
- Linkable

Control panel D92



Picture 23. Talomat control panel D92

- 10 operation buttons
 - Button background lighting is brighter when activated
- 128x64 pixel monochrome LCD display
- Integrated light level sensor

System connections:

- 12/24VDC light groups
- Traditional light switches
- Light dimmers
- Talomat light switches
- Motion sensor controls
- Door switch controls
- Electric outlet control
- Burglar alarm systems
- Fire sensor and alarm systems
- Water leakage sensors and alarm
- Buzzer
- Main water valve control
- Temperature measurement and alarm
- GSM control access
- Emergency battery voltage measurement

2.6 SCHNEIDER ELECTRIC

/8/ TAC VISTA

System in general:

By merging communications, data collection, information sharing and networking into a single, interoperable system, TAC Vista creates efficient, economical building control solutions that fit seamlessly with other products based on open system architecture. Combining industry-standard technology with an easy-to-use interface, TAC Vista produces an integrated building management solution that is reliable, flexible and cost-effective. Full integration of environmental control as well as facility and energy management in a single software package allow you to customize TAC Vista for any building and security management application. TAC Vista is based on totally open architecture, which gives customers freedom of choice in selecting products from a wide range of suppliers, yielding true vendor independence. TAC Vista runs on Microsoft® Windows® with standard LAN communication on Ethernet® or fiber optics using TCP/IP and standard network equipment. Field bus communication features the open LonWorks® technology, which is used by more than 3,000 vendors worldwide.

Using TCP/IP, TAC Vista host workstations can communicate across the Internet and existing commercial WAN/LANs. TAC Vista is eminently suited for any building management application, regardless of the building size, the number of buildings or what distances separate the buildings. It also manages multi-campus office parks and district-wide school systems just as efficiently as single, small office buildings. Alarms and historical logs provide system monitoring that is both reliable and flexible. TAC Vista operators can respond to critical alarms in seconds. The receipt of an alarm can even automatically display a specific system page, giving the operator quick, graphical access to the situation.

Connections:



Picture 24. Tac Vista units

Table 1. TAC Vista modules and controllers

	Controllers						I/O-modules				
Device	Xenta 281	Xenta 282	Xenta 283	Xenta 301	Xenta 302	Xenta 401	Xenta 411/412	Xenta 421A/422A	Xenta 451A/452A	Xenta 471	Xenta 491/492
Usage	Small applications			Medium applications		Large applications	I/O-expansions				
I/O-connections	12	16	12	20	20		10	9	10	8	8
Digital inputs	2	2	2	4	4		10	4			
Termistor inputs		2	4	4	4						
Universal inputs	4	4		4	4				8		
Analog inputs										8	
Digital outputs (relay)	3	4		6	4			5			
Digital outputs (triac)			6								
Analog outputs	3	4		2	4				8		2
Number of I/O-modules				2	2	10					
LonWorks-variables											
SNVT inputs	15	15	15	15	15	125		Yes (1)	Yes (1)		
SNVT outputs	30	30	30	30	30	125		Yes (1)	Yes (1)		

2.7 HONEYWELL

/9/ Spyder system

System in general:

Spyder Unitary & VAV Controllers use the Echelon® LONMARK® protocol for openness and interoperability, allowing them to be used with other LONMARK devices or used individually as a standalone system. Merging technology, comfort and savings makes Spyder a reliable system for individual room temperature control and pressure-independent or pressure-dependent flow controls. Wide application flexibility for all VAV and constant volume terminal unit applications, maximum energy savings through time-of-day control, load optimization and occupancy are also key features of the system.

You can gain automation savings through features such as pressurization/depressurization, night purge, morning warm-up and terminal regulated air volume. With a large number of inputs and outputs, Spyder can be used on any piece of equipment and will give you the flexibility to create any application. Just determine what you need done, then program Spyder to control it all.

Connections:

Due to large number of controllers available, only two are listed here as an example.

PUL4024S/U



Picture 25. Honeywell Spyder PUL4024S/U

- 4 Universal inputs
- 2 Analog outputs (Pulse Width Modulation, Floating, Staged On/Off)
- 4 Digital outputs
- LonWorks communication

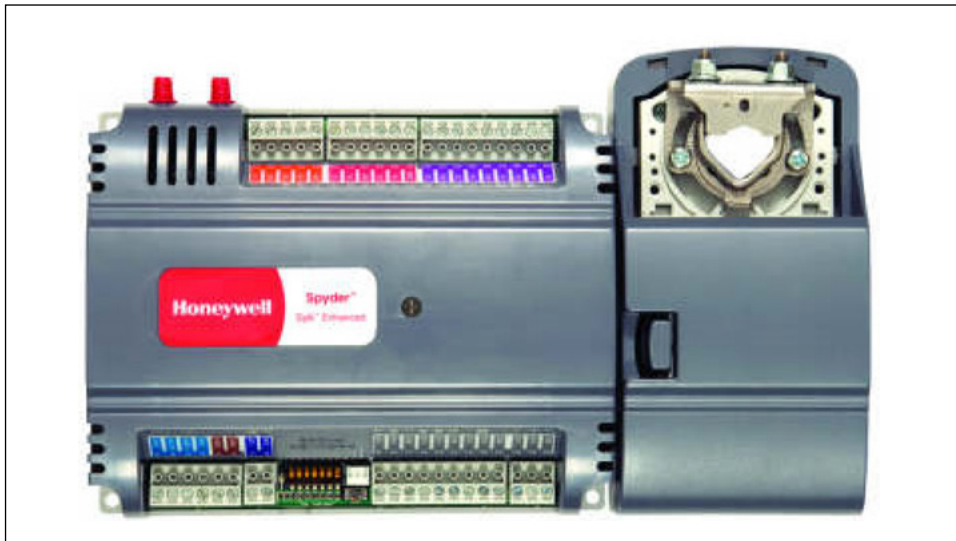

Picture 26. Honeywell Spyder PVB6436AS-ILC-US/U

- 6 Universal inputs
- 4 Digital inputs
- 3 Analog outputs (Pulse Width Modulation, Floating, Staged On/Off)
- 6 Digital outputs
- Integrated Actuator & Pressure Sensor
- BACnet MS/TP communication

2.8 DELTA CONTROLS

/10/

System in general:

Delta Controls fully integrated BACnet system of controllers includes HVAC, Lighting and Access. The entire system can be controlled from a single seat workstation or any remote site with Web access.

Lighting Controls for the Delta Controls Lighting System offer a full featured control of lighting loads. With a selection of product sized to handle from small to large numbers of lighting channels, the product can fit the application rather than the reverse. For On/Off (digital) control the channels can be tied externally to switches, photocells, occupancy sensors, and any other contact driven control, and internally to schedules, programmable overrides, co-ordinate driven astronomical clock or any other custom programmable sequence required. Delta Controls dimming solution is flexible and expandable. 0-10V outputs for dimmable ballasts provide control based

on light levels (daylight harvesting), setpoints, scenes, or any custom programmable sequence desired. Built in logging is part of every controller. It allows for keeping track of burn hours per relay channel for scheduled relamping to maintain design lumen output. Operators can review how the system was operating at a given time. Building owners can track energy savings provided by control strategies.

HVAC Controls for Delta Controls hardware are Native BACnet. Native BACnet means that the database objects in the controller can be seen by other BACnet systems and that data can be exchanged between other BACnet devices without the need for a Gateway (separate piece of hardware that maps data between Communication Protocols). Delta's hardware is easily added to other vendor's BACnet architectures because we have implemented many of the BACnet standards optional properties and have rendered them writeable. Delta Controls System Managers (DSM), System Controllers (DSC) and Application Controllers (DAC) support peer-to-peer data communication.

Connections:

Delta Controls offers a wide variety of products. Only two are listed here as an example.

DSC-1616E



DCS-1146E

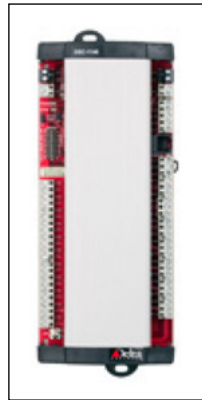

Picture 27. Delta Controls DSC-1616E

- 16 Universal inputs
- 16 Analog outputs (0-10V)
- Twisted-Pair Ethernet
- BACnet MS/TP
- RS-232

Picture 28. Delta Controls DSC-1146E

- 11 Universal inputs
- 6 Binary triac outputs
- 4 Analog outputs (0-10V)
- BACnet MS/TP
- Delta LINKnet
- Serial RS-232

2.9 BECKHOFF

/11/ ETHERCAT

System in general:

Outstanding performance, flexible topology and simple configuration characterise EtherCAT (Ethernet for control automation technology), the real-time Ethernet technology from Beckhoff. EtherCAT sets new standards where conventional fieldbus systems reach their limits: 1,000 distributed I/Os in 30 µs, almost unlimited network size, and optimum vertical integration thanks to Ethernet and internet technologies. With EtherCAT, the costly Ethernet star topology can be replaced with a simple line or tree structure – no expensive infrastructure components are required. All types of Ethernet devices can be integrated via a switch or switch port. Where other real-time Ethernet approaches require special master or scanner cards, EtherCAT manages with very cost-effective standard Ethernet interface cards.

On the hardware side, EtherCAT technology is located in EtherCAT Terminals, for example. The I/O system in protection class IP 20 is based on the housing of the tried and tested Beckhoff Bus Terminal system. In contrast to Bus Terminals, where the fieldbus protocol data is converted within the Bus Coupler to the internal, fieldbus-independent terminal bus, the EtherCAT protocol remains fully intact down to the individual terminal. In addition to EtherCAT Terminals with E-bus connection, the proven standard Bus Terminals with K-bus connection can also be connected via the BK1120 EtherCAT Bus Coupler. This ensures compatibility and continuity with the prevalent system. Existing and future investments are protected.

Example system configuration:

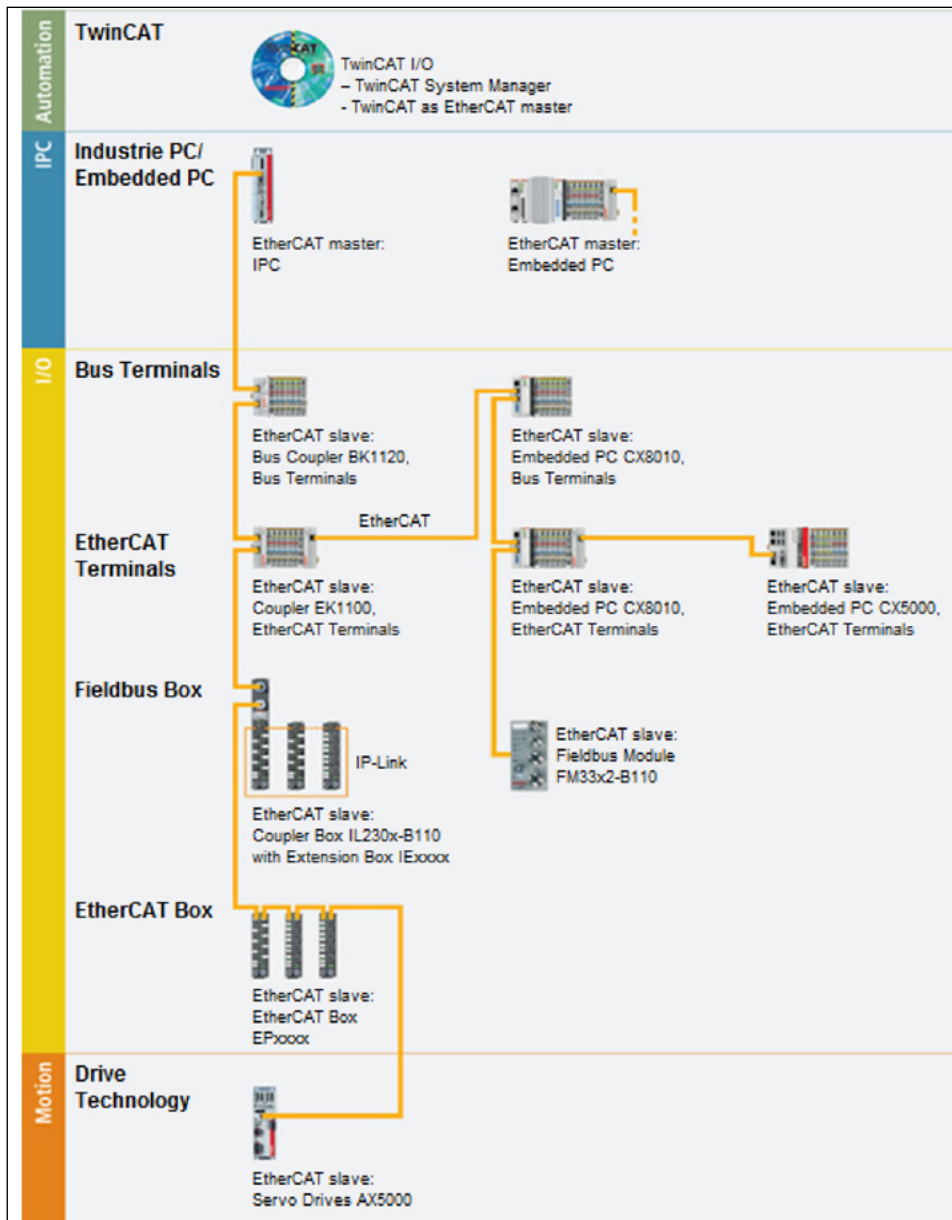

Picture 29. Beckhoff EtherCAT system configuration example

2.10 SIEMENS

/20/ SYNCO LIVING

System in general:

Home automation and control system Synco living from Siemens handles many home tasks (HVAC, lights and blinds) that reduce energy consumption and improve comfort level. That can mean up to 30% less heating energy used – and lower CO₂ emissions for your home. Synco living allows tenants to comfortably control their building services – and it also displays consumption data in an easy-to-understand format. Synco living fulfills all requirements to achieve energy efficiency class A in accordance with EN 15232.

Synco living is a comprehensive home automation system with a wide range of components. The system allows you to control your heating, ventilation, and air conditioning systems, conveniently switch electrical appliances on and off, and monitor the rooms of your home for smoke. The system also shows you which windows are open, tells you about the current outdoor temperature and barometric pressure, and provides an easy, convenient way to control lights and blinds. Thanks to implementation of the internationally recognized KNX communication standard, electrical appliances, heating, ventilation, air conditioning systems, and household appliances from different manufacturers can communicate with each other. This also ensures the integration of any future comfort, security, and energy saving functions. Along with wireless KNX capabilities, the central control unit can communicate with other devices via a wired KNX connection.

System components:

<p>Central apartment unit</p> <p>1</p>  <p>From the central apartment unit, you can easily control all functions in up to 12 rooms and review settings on the display.</p>	<p>Multi-unit controller</p> <p>7</p>  <p>The multi-unit controller can control up to two independent heat systems, e.g. radiator and floor heating, and a ventilation system with up to three stages.</p>
<p>Room unit</p> <p>2</p>  <p>The room unit measures and displays the room temperature and lets you change settings specifically for that room.</p>	<p>Radio-socket adapter, switch/dim</p> <p>8</p>  <p>The radio-socket adapter enables you to remotely control plugged-in electrical appliances and to dim lights.</p>
<p>Room temperature sensor</p> <p>3</p>  <p>The room temperature sensor measures the room temperature.</p>	<p>Outdoor temperature sensor</p> <p>9</p>  <p>The outdoor temperature sensor measures the outdoor temperature and barometric pressure.</p>
<p>Web server</p> <p>4</p>  <p>The Web server connects the home automation system to the internet, allowing you to access and operate the system remotely over the Web.</p>	<p>Smoke detector</p> <p>10</p>  <p>The smoke detector will detect any smoke and trigger an alarm.</p>
<p>Radiator control actuator</p> <p>5</p>  <p>The radiator control actuator senses the room temperature, regulates the amount of water going into the radiators, and thereby controls the room temperature.</p>	<p>Lighting and blinds controls</p> <p>11</p>  <p>You can conveniently control lighting and blinds with wireless controls – centrally, locally in a room or as a scene.</p>
<p>Heating circuit controller</p> <p>6</p>  <p>The heating circuit controller controls the amount of water going into the radiators and thereby the room temperature.</p>	<p>Door/window contact</p> <p>12</p>  <p>The door/window contact detects whether windows and doors are open or closed.</p>

Picture 30. Siemens Synco-living system components

3 Automation Busses

This chapter describes the basic information and characteristics of different automation busses in use today. Earlier the automation busses were mostly used in industrial automation, but nowadays most house- and home automation systems incorporate atleast one of these busses. The busses are used to link several devices to the automation system. The limitations and operation principals of busses vary as can be seen on the following table:

Table 2. Automation busses

Name	Standard	Media	Data transfer speed (twisted pair, electrical wiring)	Main usage
LonTalk	EIA-709	Twisted pair, fiber optic, RF, electrical wiring	1.25 Mb/s, 10 kb/s	Building-, industrial- and home automation
CeBus	EIA-600	Twisted pair, Coaxial cable, RF, IR	10 kb/s, 7800 b/s	Home automation
BatiBus	National standard in France	Twisted pair	4800 b/s, -	Building and home automation
EHS	ENV 13154, pre-CEN standard	Twisted pair, electrical wiring, Coaxial cable, RF, IR	64 kb/s, 2400 b/s	home automation
EIB	National standard in Germany	Twisted pair, electrical wiring, RF	9600 b/s, 1200 / 2400 b/s	Building-, and home automation
X-10	De facto – standard	Electrical wiring, RF, IR	- , 100b/s	Home automation

Konnex / KNX	International standard ISO/IEC 14543-3	Twisted pair, KNX-cable, RF, Ethernet, fiber optic, electrical wiring (Powerline)	9600 b/s, 2400 b/s	Building-, and home automation
Modbus	De facto – standard	Ethernet, EIA/TIA-232-E, EIA-422, EIA/TIA-485-A; fiber optic, RF	- , -	Building-, industrial automation
M-Bus	EN 1434-4	Twisted pair	38.4 kb/s -	Building-, and home automation
BACnet	ISO 16484-5			Building-, and home automation
LON	ANSI/CEA-709.1-B	Twisted pair, electrical wiring, fiber optic, RF	78 kbit/s, 5.4 / 3.6 kbit/s	Building-, and home automation
AS-I	IEC 62026-2, EN 50295	Flat pair cable	- , -	
Fieldbus	IEC 61158	Twisted pair, fiber optic	31.25 kbit/s, -	Industrial automation
Profibus	IEC 61158/IEC 61784	Profibus cable	- , -	Industrial automation
Profinet & Ethernet	(ISO) TC97SC6, ISO/IEEE 802/3	Cat6 / twisted pair	100 gigabits/s, -	Building-, industrial- and home automation
Dali	IEC 60929, IEC 62386	electrical wiring	- , 1200 bit/s	Building-, and home automation

4 What Is in Research Phase?

/12/, /13/, The EU-commission adopted the strategy for competitive, sustainable and secure energy on 10th November 2010. The goal of this strategy is to cut the greenhouse gas emissions in the EU by 20% by the year 2020. This strategy is implemented in house manufacturing industry so that from 2020 all new buildings should be nearly Zero-Energy Buildings.

/14/, Nearly zero energy building is technically defined as national cost optimal energy use of > 0 kWh/(m² a) primary energy. In order to end up with proposed general definition, it was needed to clarify which energy flows shall be included in energy performance assessment and how the primary energy factors should be used for primary energy indicator calculation. For the uniform methodology, a general system boundary definition was established with inclusion of active solar and wind energy, as well as the guidance for technical meaning of “nearby” in the directive.

The future of automation systems is driven by needs and demands of the industry and end-users. Building regulations also play a big role in what the next generation of automation will be like. To meet these demands, studies in various fields are conducted around the world. These studies provide a base for developing more efficient, reliable and cost-efficient state-of-the-art automation systems. Here are some highlights of the recent researches:

/15/ IMPACT OF USER HABITS IN SMART HOME CONTROL

Lifestyle and habits of users have a direct effect on the energy performance of dwellings and facilities. Hence, in the built environment, advanced control strategies must adapt to user behaviors trying to keep a commitment between energy consumption and comfort requirements. This study performs a sensitivity analysis for control strategies based on usage profiles, where the input under variation is the level of habit-regularity of users. Therefore, different hypothetical user models are created and tested. The results of this analysis provide a better understanding of how user behavior affects the energy and comfort performance in dwellings under smart control and paves the way for enhanced controller design. The aims of the research cover three issues:

- To check the fitness of control based on profiles taking into account a sensitivity analysis for habit regularity, and to compare such control strategies with classic ones (e. g. on/off, schedule-based).
- To collect and abstract some knowledge in use these results to enhance controller and system designs, according to the flexibility shown in previous works.
- To have a better appraisal of the effect of user behaviors in the comfort and energy performance.

Results of previous researches suggest that additional enhancements can be achieved if some extra clustering outputs are deployed to know the level of habit-regularity of users. This is the starting point of the present research. People are prone to follow occupancy trends with a daily or weekly cadence. Diverse ways to store daily profiles for the habit analysis are possible: a single database for each day of the week, two databases (working days and weekend days), or even three (working days, Saturdays and Sundays) are reasonable. In order to facilitate the study, some assumptions are taken in the model design phase and in the simulation performance. For the tests, it's considered that the research team is dealing only with the database of one working day of the week (for instance, Monday). Therefore, clustering tools and the settings/parameters of the controllers take into account only the same weekday of the previous week, i.e. the experience and usage of the last Monday. Without any loss of generality, the tests take the liberty of simulating several consecutive Mondays.

According to the simulation results, control strategies based on occupancy profiles keep the best performances in the habit-regularity sensitivity analysis. The combined strategy is good enough for the current application. Nevertheless, controllers based on habits keep better results even in improbable extremely random cases. In addition to reaching better comfort and energy efficiency as a direct control response, deploying habit, behavior and usage profile detection has further important benefits in the building and smart home environment. Usage profiles can help diverse application controllers and they can be stored and analyzed by energy tools for energy performance studies during building design phases. Finally, habit profiles can be used to generate reports and advice in order to provide valuable feedback that allows users to improve their energy and comfort behavior. In addition, the awareness of habit-regularity also allows the self-adjustment of the controller parameters.

/16/ INFORMATION MODELING IN HETEROGENEOUS BUILDING AUTOMATION SYSTEMS

Modern Building Automation Systems (BAS) are highly heterogeneous where often a plethora of technologies is necessary to satisfy the needs of all underlying application domains. On the way to "intelligent" buildings and smart control, a key challenge to be solved is interoperability at the information level. In order to use data in a

technological-independent way, it must be possible to represent and access them in a generic way.

Modern Building Automation Systems (BAS) are distributed systems where the control functionality is spread across a three level hierarchy. Immediate interaction with the environment is associated with the field level where collecting data (measurement, counting, metering) and physically acting upon the process (switching, setting, positioning) is handled. The automation level encompasses the various aspects of automatic control – that is, the execution of control loops and sequences, building upon the functionality of the field level. Global configuration and management tasks (such as visualization and accessing trend logs) are considered management level functionality. Due to the differing requirements of these different functional levels, there is no single technology that can be used to satisfy the needs of all levels. As a result, like in industrial communications, BAS are extremely heterogeneous where many different network technologies and communication standards are used.

Some technologies are more prominent at the management level (e.g., BACnet) while others are more used at the automation and field level (e.g., LonWorks, KNX, ZigBee, EnOcean). However, there are even some technologies that are only dedicated to a single functional level. The current prime example is Digital Addressable Lighting Interface (DALI), widely accepted for lighting applications providing field level functionality only. The main problem of such heterogeneous BAS is the lack of interoperability at the information level. Data under control of dedicated devices is represented by different ways since each technology defines its own interworking model. This research tackles information modeling for building automation systems using OPC UA. It is structured as follows:

- An introduction to OPC UA with special focus on the supported information modeling capabilities
- analyzes on the interworking models of the most popular open BAS standards and presents a way how these models can be represented in OPC UA. To hide the complexity of the underlying technologies
- proposes a generic approach that provides software developers the opportunity to implement management applications without dealing with the underlying technologies

While this research focuses on the representation of datapoints and parameters of BAS objects, the presented information model can be further extended by additional meta-information. For example, to be able to read and write datapoints, address information that can be used to access the datapoints over the network has to be assigned to the datapoints and parameters. This address information could be managed by the protocol driver that provides the access to the networks. The user-defined object types must be specified that contain dedicated variables that are used

to represent the corresponding addresses. Further enriching the information model could also concern the building structure and layout, as well as the network topology. The development of information models for other technologies will be one of the next steps. The scientific challenge and also the risk of the proposed mapping is to guarantee completeness. While OPC UA provides a rich set of modeling capabilities, it has to be verified whether the concepts of the different BAS technologies can fully be mapped to OPC UA. Based on the proposed proof-of-concept implementation, such a verification is one of the next steps. Finally, if the developed information models are approved, submitting them to the OPC foundation for standardization may be considered.

/17/ PERFORMANCE EVALUATION OF WIRELESS HOME AUTOMATION NETWORKS IN INDOOR SCENARIOS

Transmission of control information in home local networks is gaining increasing importance. Especially in the context of smart grids several applications already exist and evolve that demand the transmission of control information in home networks. This research presents a methodology for the evaluation of wireless smart homes and home automation networks (HANs) in indoor scenarios. The methodology is applied to investigate the performance of actual wireless technologies that can be used to interconnect devices in a smart home environment. The technologies are compared with each other by investigating the performance in realistic European indoor scenarios. Additionally, they are evaluated with respect to their reliable indoor coverage range.

Smart grids require an exchange of control and sensor information between all components. Besides consumers and producers in the higher levels of hierarchy, like large industrial plants, small consumers and producers in the distribution network are also an important part of the smart grid. Hence, smart homes and intelligent buildings play a key role, because they are the endpoints in the distribution network. In smart homes, the household appliances are remotely controlled by a local energy management system (EMS) in order to increase the energy efficiency. The EMS acts as a gateway to the smart grid that forwards requests to the applicable smart home devices. It optimizes the energy consumption of the smart home and the overlying smart grid. Sensors and smart meters are also connected to the EMS. They transmit monitoring data in real time, which are used to evaluate the current state of the energy system.

Several challenges must be solved in order to realize this scenario, because smart homes are not widespread until now. Therefore, it is desirable to upgrade existing homes into smart homes applying HAN technologies. Several technologies are available that can be used to interconnect the devices within a HAN. Especially wireless communication technologies provide a high amount of flexibility and can be easily retrofitted in contrast to wired solutions. In addition, they have an advantage over systems applying power line communication as wireless technologies do not require a direct access to the electrical installation, which might not be available in certain devices. The main challenge arises at this point, as multiple technologies

compete with each other in this field of application. A trend to a de facto standard for HANs is not noticeable. All standards differ in their characteristics and have specific advantages and disadvantages regarding the physical data transmission in the wireless indoor channel. Thus, an evaluation methodology is needed in order to compare the performance of wireless HAN systems in realistic indoor environments.

This research presents a performance evaluation of different wireless HAN and smart home technologies for the use in the evolving smart grid energy system. In terms of a realistic system comparison, it is essential to evaluate the individual performance within realistic indoor environments. Therefore, two evaluation scenarios from a real existing building were selected in order to present representative evaluation results. Five different wireless technologies, which are often named in the context of smart homes, have been selected and characterized with respect to their PHY and MAC layer parameters. The proposed evaluation methodology has also been introduced. The methodology applies two objective performance comparison metrics, which have been derived and described in detail. The first metric was the required transmission energy per packet. This metric describes the energy that is required in order to reliably operate a wireless link. It can be interpreted as the efficiency of the PHY that takes all parameters into account, like the transmission frequency. The second parameter was the reliable indoor coverage range. This is the range that can be reliably achieved even under the presence of deep fades that are caused by multipath propagation. This parameter considers MAC layer characteristics as well, like an ARQ mechanism. Besides that, an equation for the calculation of the static building attenuation has been derived, and the parameters were described. The presented methodology can also be applied to investigate the performance of other HAN standards in this field of application. The simulations have been carried out under worst case conditions in order to evaluate the reliability. The model has been successfully validated by measurements within the two evaluation scenarios. It has been shown that the model provides a good approximation of the building attenuations for a given indoor scenario. Finally, the evaluation results for both scenarios and the reliable indoor coverage range have been presented and discussed.

/18/ ENERGY SAVING PROJECT FOR HEATING SYSTEM WITH ZIGBEE WIRELESS CONTROL NETWORK

An energy saving system able to optimize power management and energy efficiency of a home heating plant is proposed. Thanks to an advanced interface and control architecture based on ZigBee wireless devices, a continuous control of temperature is warranted making the heating plant efficient. The system uses a sensor and actuator combination to control and guarantee the desired system parameters; the information is transferred point-to-point using ZigBee communication network and it's sent to a central unit used to check the peripheral device states and to take appropriate measures in case of failure or alarm.

One of the greatest challenges in contemporary engineering, regarding automation and control, is to achieve products aimed to increasing energy savings customizable

by the user. The solution proposed in this research offers an actual and innovative technology in integrated technology. It provides wide flexibility, ensures automatic and customizable management of the modules that make up the system. The system collects temperature data in the rooms where it's installed and from external environment. Using the collected information, the control unit is able to adjust the heating system valves which regulate the warm water flow. This action can be performed on all water columns or on some water columns. The data collection from temperature sensors will be performed with wireless network, implemented by ZigBee technology.

The advantage obtained by the control system is the intelligent management of the plant obtained by sending data to a central station via ZigBee wireless communication network. System maintenance can be easily and efficiently planned from the central station allowing additional savings. Information collected can be processed on site by the controller accessible only by the customers or by authorized workers. This control unit will send summarized data and eventual alarm messages to a central server, monitored by maintenance staff. The summary information can be submitted over Ethernet, or in case of need, using GPRS. For reporting alarms and emergency, the system is scheduled to use prerecorded phone calls (or to send a text message to mobile phones). In addition, the unit is equipped with selfdiagnostic function, based on the detection of voltage, current and temperature to allow monitoring of correct operation.

The proposed system is particularly suitable for heating system in urban residential or working building. The system is flexible, extendable at any time and fully adjustable to user needs. The simplicity of ZigBee, the reliability of electronic components, the feature of the sensor network, the processing speed, the reduced costs and the ease of installation are the features that characterize the proposed system, which presents itself as an interesting engineering and commercial solution.

/19/ TEMPERATURE CONTROL USING INTELLIGENT TECHNIQUES

This research presents the comparison of various intelligent techniques used for temperature control of water bath system. Different control schemes namely PID, PID using Genetic Algorithms(GA-PID), Fuzzy Logic Control, Neural Network, Adaptive Neuro- Fuzzy Inference System(ANFIS), and GA-ANFIS have been compared through experimental studies with respect to set-points regulation, ramp-points tracking, influence of unknown impulse noise and large parameter variation. The merits and limitations of each scheme has been brought out.

Classical control theory usually requires a mathematical model for designing the controller. The inaccuracy of mathematical modeling of the plants usually degrades the performance of the controller, especially for nonlinear and complex control. Temperature control is an important factor in many process control system. If the temperature is too high or too low, the final product is seriously affected. Therefore, it is necessary to reach some desired temperature points quickly and avoid large overshoot. Since the process control system are often nonlinear and tend to change in an unpredictable way, they are not easy to control accurately. The applications of

neural networks to control systems have also become increasingly important. The massive parallel processing, nonlinear mapping and self-learning abilities of neural networks have been motivating factors for development of intelligent control systems. A genetic algorithm (GA) is a parallel, global search technique that emulates operators. A GA applies operators inspired by the mechanics of natural selection to a population of binary string encoding the parameter space at each generation; it explores different areas of the parameter space, and then directs the search to regions where there is a high probability of finding improved performance. In this paper, GA is used to tune gain of PID controller and membership function of ANFIS.

The research shows, that GA optimized ANFIS has resulted in better regulation performance & tracking performance, thus minimizing overall absolute error Use of GA-ANFIS reduce design efforts. Also, this property makes it able to deal with the problem of a changing environment or plant, which cannot be handled perfectly by conventional controllers like the PID controller.

5 Building Technology

Definition of building technology: Building technology is entirety of property's technical services, -systems and -devices. Building technology includes e.g. heat, energy, air, water, light and information conveying and safety/moving services in the house. Building technology produces controlled conditions for the above-mentioned factors in the house. Building technology is at times described as a dynamic section of the house or sometimes the brains of the house because building technology include functional components of the house.

5.1 SENSORS USED IN MEASUREMENTS IN BUILDING TECHNOLOGY

/64/ - /71/ Sensor is a measuring device, which recognizes the value of process variable, and sends measurement data for instance to controller. In this chapter is listed typical sensors used in modern building technology.

TEMPERATURE SENSORS

One of most common temperature sensor used with heating control in buildings is NTC resistor. Acronym NTC comes with *Negative Temperature Coefficient*. NTC resistors exist with great variety of resistance values. Nominal resistance value is announced at temperature of 25 C. 10 kΩ value is most common. It has advantage of simplified arrangement of measurements. Connection wires resistance does not influence much. In addition deep slope on resistance-temperature curve makes it less sensitive of other errors. Disadvantage of applying NTC resistor sensors is highly nonlinear R-T dependence. It makes calculation of temperature quite complicated.

NTC resistor resistance – temperature dependence is described most accurately with Steinhart-Hart equation.

$$1/T = A + B \cdot \ln(R) + C \cdot (\ln(R))^3 \quad (1)$$

T = Absolute temperature in Kelvin

R = Resistance at temperature T

A, B, C are coefficients which are supplied by manufacturer

Problem with this formula is quite demanding resources of microcontroller which takes care of calculations.

More common, simplified expression is well known equation:

$$R(t) = R_{25} * \exp(\beta * (1/(t+273) - 1/298)) \quad (2)$$

$R(t)$ is Resistance with temperature in C degrees.

R_{25} is resistance nominal value at temperature of 25 C

β is a constant given by manufacturer.

Ordinary β has value between 3500 K - 4200 K. At room temperature slope of resistance change is roughly minus 4,5 %/C.

Formula (2) is not final solution of temperature calculation because inverse expression is needed in order to predict value of temperature. Normally resistance is known and temperature is unknown quantity.

Other common temperature sensor is called with acronym RTD. It is resistor made of some pure metal wire or membrane. Nickel and Platinum is common. Most demanding cases Pt100 is good choice. It has resistance of 100 Ω at temperature of zero Celsius. Disadvantage of Pt100 sensor is low sensitivity and low resistance value, which makes good measurement arrangements very requiring. Higher resistance values are desired. Advances of manufacturing process has make possible to product cheap, small size 1000 Ω platinum film resistors on ceramic substrate. Self-heating effect and connection wire resistance influence has diminish substantially compare to smaller value 100 Ω RTD sensors.

Resistance thermometer elements can be supplied which function up to 1000 °C. The relation between temperature and resistance is given by the Callendar-Van Dusen equation,

$$R_t = R_0 [1 + At + Bt^2 + Ct^3(t - 100)]$$

R_t is resistance at temperature t

$$A = 3.9083 * 10^{-3} \text{ C}^{-1}$$

$$B = -5.775 * 10^{-7} \text{ C}^{-2}$$

$$C = -4.183 * 10^{-12} \text{ C}^{-4} \text{ applied at range } -200 \text{ C} < t < 0 \text{ C, zero otherwise}$$

Advantages of Platinum sensors are good time stability, good linearity, guaranteed error margins, standardized specifications, numerous suppliers. Also price is reasonable, unit cost can be order of 1,5 €.

Applying of RTD resistors is quite straight forward. Two error sources must consider. First, smaller size of temperature sensor makes its self-heating. That effect is described with Dissipation Factor, DF. For example typical value of DF is 0.75 mW/C. Even low as 0.001 W of power makes overtemperature $\Delta T = 1.3 \text{ C}$. This amount power becomes with 1 VDC of measuring voltage in Pt1000 sensors. 10 k Ω NTC resistor has 1mW Power dissipation with 3.16 VDC drive voltages.

There are many different measurement bridge and Cable arrangements with resistive sensor elements. It is good practice to calculate Cable resistance error effect. Many cases simplest 2-wire connection is not adequate.

HUMIDITY SENSORS

Varying Capacitance principle humidity sensors represent dominant technology with humidity measurements. Sensor is based on porous dielectric, which can absorb water from air. Water content varies capacitance value of the sensor. That principle offer many benefits. Water content is inherently proportional of relative humidity of the air. Temperature effect is negligible. Reaction speed is fast, couple of seconds. Measurement range is even 0.. 100 % RH. Temperature range is wide, even -40 C – +120 C. Reliability and stability are excellent.

There are many supplier of humidity sensors. Brief search from internet gives over twenty suppliers of Humidity sensors. For example Honeywell, GE sensing, Sensiron ja Vishay group. Honeywell HCH-1000 series is very popular. Price Tag is from 4 € is possible at this moment.

Varying Resistance principle has applied with cheapest humidity sensors. This type sensor works with narrow temperature span and more limited measurement range. (10..60 C, 20..90 % RH). Example of this sensor category is Multicomponent Type HCZ-D5. Its Unit Price is 0.5€.

Sometimes only Dew Point circumstances must recognize. There are special sensors optimized for that purpose only. Common name of these humidity sensors are Dew point Sensor. Those sensors works with resistive principle. They don't brake with liquid moisture. Example of this category is SHS-A4 device.

Application area of Dew Point sensor is to control blowers or heaters which are installed to prevent condense water formation on certain surface.

CARBON DIOXIDE SENSORS

Content of CO₂ in the air is one dominant factor of intelligent ventilation. Measuring of Carbon dioxide is not easy task. Advance in technology has made this task cheaper and more precise.

There are autonomously working devices, which may be installed on the wall. Aim of these sensors is to switch on blowers, in case of CO₂ content outreach the threshold value. There are also plain sensor elements and OEM subcircuit boards, which are intended to CO₂ measurement.

T8013 Telaire® CO₂ Switch

Wall-Mounted Switch for Ventilation Control

Features:

- Reliable (15 years of low-cost infrared sensor manufacturing)
- Intuitive Light display (VLI)
- 115/230 Vac power supply
- 230 V 8A rated output relay
- Pre-calibrated
- Maintenance free (calibration maintained with patented ABC Logic)
- User selectable output switch point



Picture 31. Wall-mounted CO₂ sensing device

Two different measuring principle are applied with CO₂ sensors on the market. One operation principle is based on electro chemistry cell. Its output variable is small current or voltage. Other principle is based on measurement of attenuation of an infrared beam.

Electro chemical working principle represents the cheapest technology. Its drawback is aging and possibility of poisoning with certain contaminating gas in the air. Life span is order of five years.

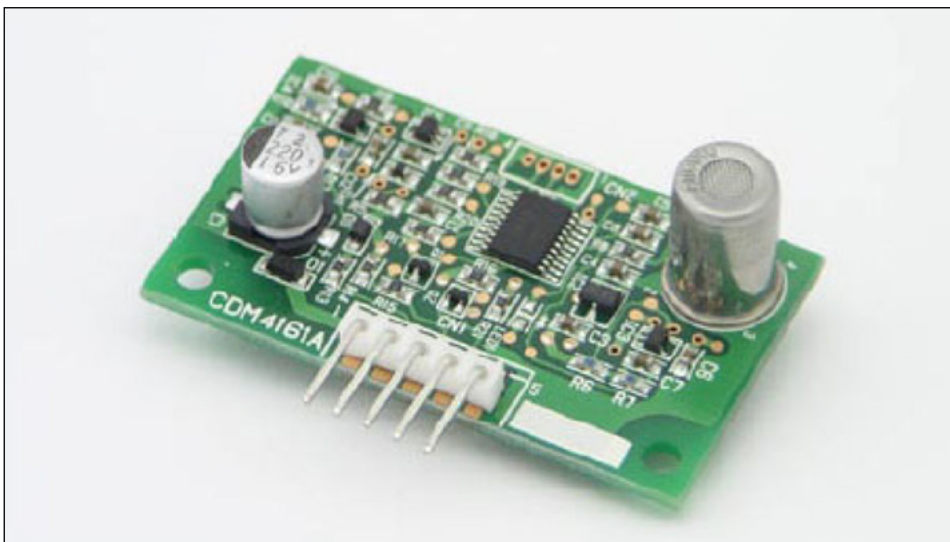

Picture 32. CO₂ measurement sub assembly

INFRARED MEASURING PRINCIPLE IN GAS ANALYZERS

Molecules which consist of two identical atoms, like O_2 , N_2 does not absorb electromagnetic radiation in range of infrared spectrum. Instead of that Molecules like CO (Carbon Monoxide), and more complex molecules with three or more atoms, they always have characteristic fingerprint spectrum between $1\ \mu\text{m}$ - $10\ \mu\text{m}$ wave lengths.

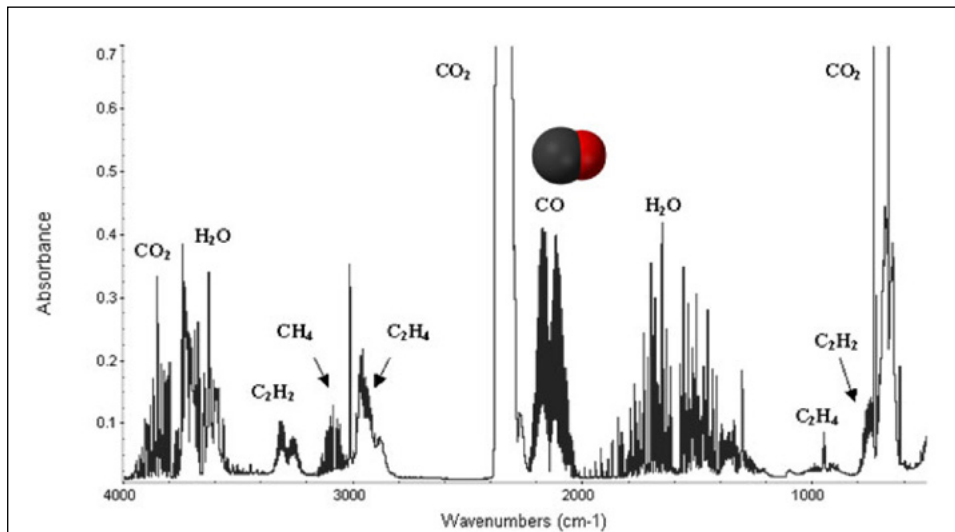

Picture 33. Examples of IR-absorption bands with different gas molecules.

Wavelength selection can be achieved using prisms or diffraction gratings, these being termed dispersive systems since they separate wavelengths spatially. Alternatively, a non-dispersive element may be used such as a multilayer thin film filter. Infrared gas sensors utilize only part of the infrared spectrum, corresponding to wavelengths which are absorbed by the gas to be detected. The optical bandwidth of a laser source is sufficiently narrow for it to be used directly, but with wideband sources such as thermal sources or even LED's some additional wavelength selection in the optical path is required to achieve usable sensitivity and selectivity. The optical bandwidth of a sensor should ideally be matched to the absorption band of the gas (matching system bandwidth to the information carrying bandwidth) which is typically in the tens or low hundreds of nanometres.

Single gas NDIR systems have a clear performance advantage over dispersive systems and as a result commercial single gas IR gas sensors, as opposed to analytical instruments, are all based on NDIR techniques.

- Ultra-low Power 3.5mW
- Measurement ranges from 0 to 1%
- Low noise measurement (<10ppm)
- 3.3V supply.
- Peak current only 33mA.
- Optional Temperature and Humidity Output



COZIR™ Ambient Sensor

Picture 34. CO2 sensor

One big challenge with IR-absorption gas sensors is cross effect of the water absorption. Water has quite a complex IR-spectrum. It has many different absorption bands. Compensation may be tricky because of the great variety of water content in the air. Luckily CO₂ has one very strong absorption band, centered at $\lambda = 4.27 \mu\text{m}$. Water has negligible absorption at the same wavelength.

CARBON MONOXIDE SENSORS

Carbon monoxide is a highly toxic, odorless, colorless gas. Exposure to carbon monoxide can cause death. A carbon monoxide alarm system is useful in homes which use a fireplace as a secondary heating system. Other markets for these devices are garages and repair shops.

In addition to proper technical act, a carbon monoxide warning system must fulfill certain regulations which make sure that these devices react properly with different CO levels.

Even though there are two standards for CO detection devices, both have the same alarm thresholds. ANSI/UL 2075 requires detectors to operate within the sensitivity parameters defined in ANSI/UL 2034. The alarm thresholds, set by CO concentration measured in parts per million (ppm), are: no alarm below 30 ppm until after 30 days; 70 ppm for one to four hours (but not less than one hour); 150 ppm for 10 to 50 minutes; 400 ppm for four to 15 minutes.

6 Heating

6.1 NEED FOR HEATING

/23/ In year 2007, 48% of the energy consumption in EU 27 took the form of heat. Heat accounted for 86 % of the energy consumption in households, 76 % in commerce, services and agriculture and 55 % in industry.

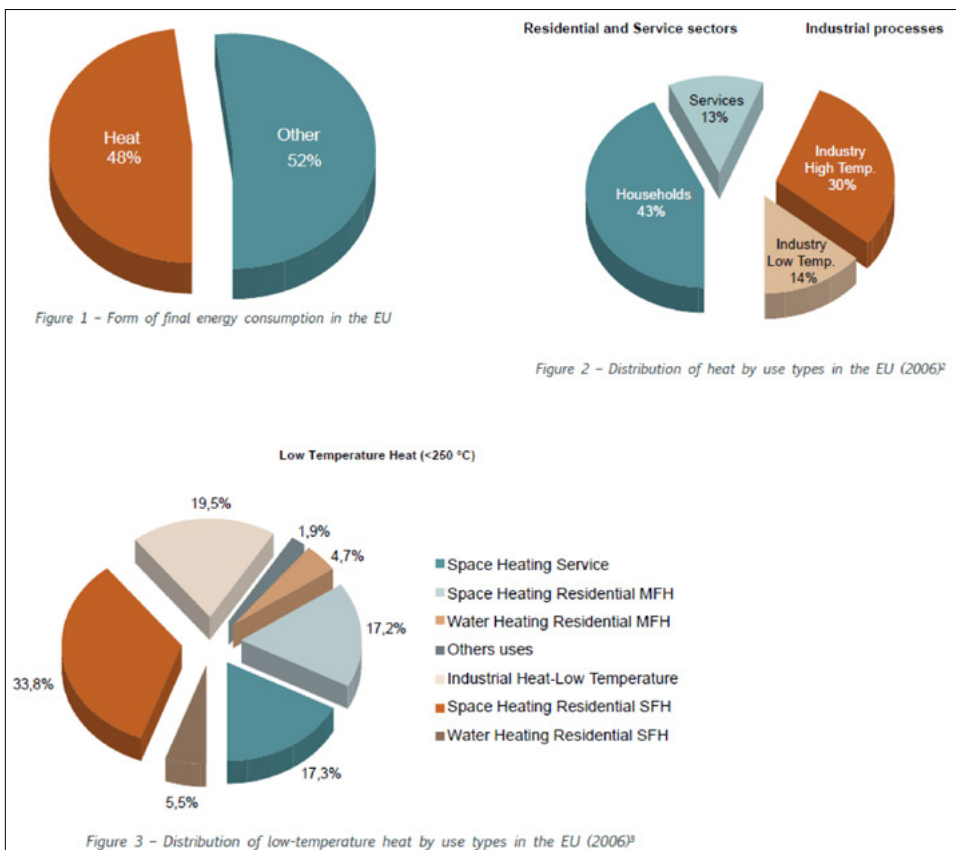

Picture 35. (low temperature heat <250°C)

- /23/ Forecasts of future heat demand in EU 27 are sensitive to increases in efficiency:
- in the insulation of the building envelope;
 - in the conversion of the respective heat-supply technology;
 - and in distribution of energy.

/23/ If efficiency gains could be realised in each of these realms, they would allow a considerable reduction in the heat demand. Below is shown two different scenarios of EU’s heating demand in future. First one is the full research, development and policy scenario (RDP) and second one is the business as usual scenario (BAU).

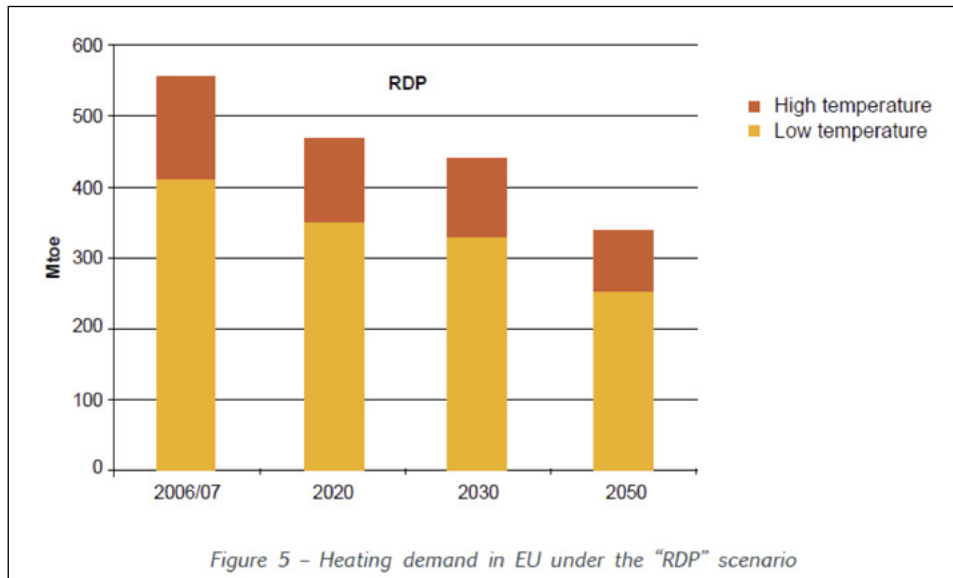

Picture 36 Heating demand in EU under the "RDP" scenario.

/23/ THE "BUSINESS AS USUAL SCENARIO" (BAU) IS BASED ON THE FOLLOWING ASSUMPTIONS:

- Moderate reduction of the heating demand compared with 2006 (on average: -5% by 2020, -10% by 2030 and -20% by 2050).
- Policy support: RE obligations only for new residential buildings; subsidies for existing residential, service and commercial buildings as well as
- for industrial applications (subsidies: 10 - 30% of the system cost) or constantly moderate rising energy prices of fossil energy.
- Medium R&D rate and therefore solutions for high energy density heat stores and new collector materials; sufficient and cost competitive
- solutions for solar thermal cooling by the year 2020.
- Medium growth rate of RHC installed capacity (10-15% per annum until 2020).

THE “FULL RESEARCH, DEVELOPMENT AND POLICY SCENARIO” (RDP) IS BASED ON THE FOLLOWING ASSUMPTIONS:

- Significant reduction of the heat demand compared with 2006 (depending on the country but on average: -10% by 2020, -20% by 2030 and -30% by 2050).
- Full policy support: RE obligations for all new and existing residential, service and commercial buildings as well as for low-temperature industrial applications or high energy prices of fossil energy.
- High R&D rate delivers solutions for cost efficient high energy density heat stores and new collector materials; sufficient and cost competitive solutions for solar thermal cooling available by 2020.
- High growth rate of RH&C installed capacity (approx. 25% per annum until 2020).

/23/ COMMON VISION FOR THE RENEWABLE HEATING & COOLING SECTOR IN EUROPE

Currently, almost 50% of the total energy consumed in Europe is used for the generation of heat for either domestic or industrial purposes. Most of this energy is produced through the combustion of fossil fuels such as oil, gas and coal – with a damaging environmental impact arising primarily from the associated greenhouse gas emissions and also from the resource extraction process. Cooling is, with few exceptions, reached by processes driven by electricity, which is still also predominantly produced from fossil fuels. The social, environmental and economic costs of climate modification are such that we must move swiftly towards a more sustainable energy economy based on renewable energy sources. For these reasons, energy scenarios often suppose a very substantial contribution of renewable energy penetration in the heating and cooling sector towards the targets set out in the Renewable Energy Sources Directive (“RES Directive”, 2009/28/EC).

In the picture below can be seen how big role single family houses has in energy usage in Finland.

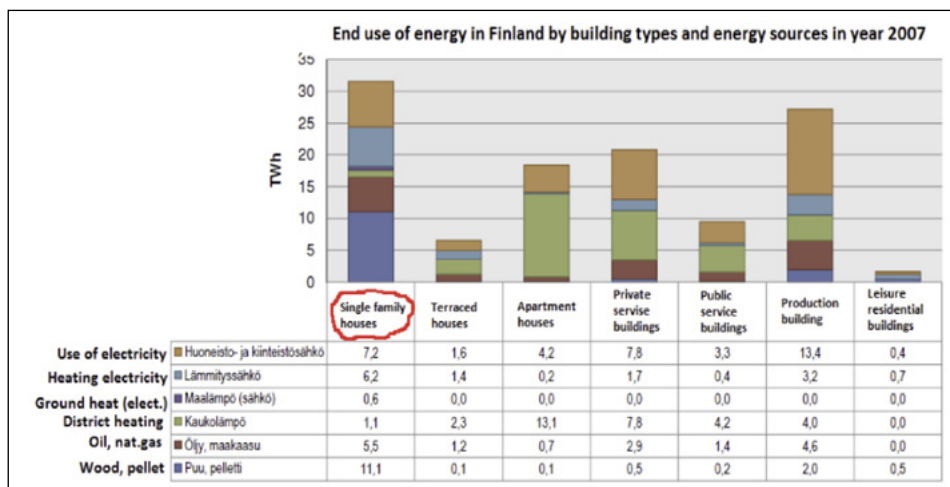

Picture 37. End use of energy in Finland by building type

6.2 HEATING CONTROL

/25/ The goal of heating control is to keep the temperature of the building in wanted level, in spite of outdoor temperature, heat loss of the building and the load of indoor heat sources. Outdoor temperature depends on season, time of day and weather. Heat losses depend on insulation of the building, air tightness, ventilation etc. Indoor heat load depends on the acts of building users, heat of the sun and the amount of the peoples. Acts of the building users includes every kind of physical activity, lighting, sauna, household appliances etc. Various heat loads can lead to indoor temperature rising in the daytime. It would be economical to store this excess heat in the structures of the house, and then use it for night-time heating. Single family house heating is in Finland most commonly controlled by the outdoor temperature. In addition there can be also wind and sun sensors to measure cooling effect of the wind and sun's warming effect, and use that info for adjusting water temperature of the central heating.

/25/ Below is shown simplified temperature control automation in picture and in graph. TE 1 measures temperature of the water going to radiators and relay the information to the controller TC. Controller tries to keep the temperature of the water in the set point by controlling three way valve via actuator. Three way valve mix water coming from the radiator circuit with hot water coming from the charger / boiler, so that temperature of the water going to the radiator circuit matches as well as possible with the heat demand. This example does not include outdoor temperature compensation.

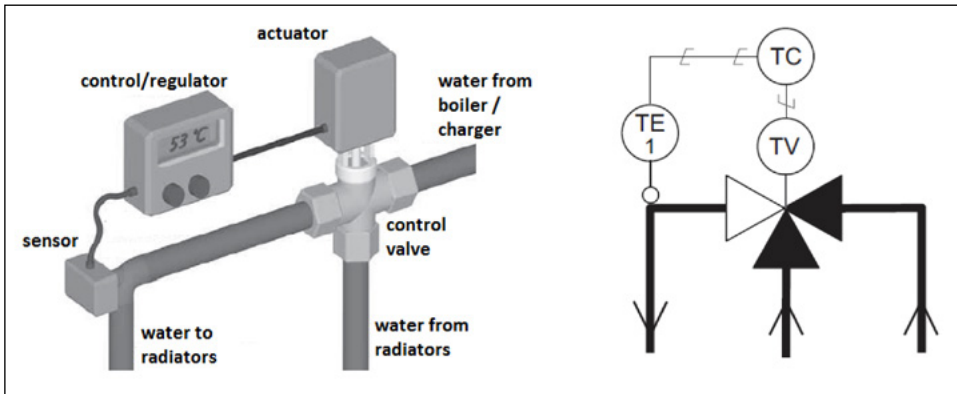

Picture 38. simplified temperature control automation

When using outdoor temperature information for temperature controlling, heating controller adjusts the temperature of the heating water going to circulation by using curve which is set. Curve depends on the heating systems, building type etc. In the next picture is Ouman EH-800 example curve for radiator heating.

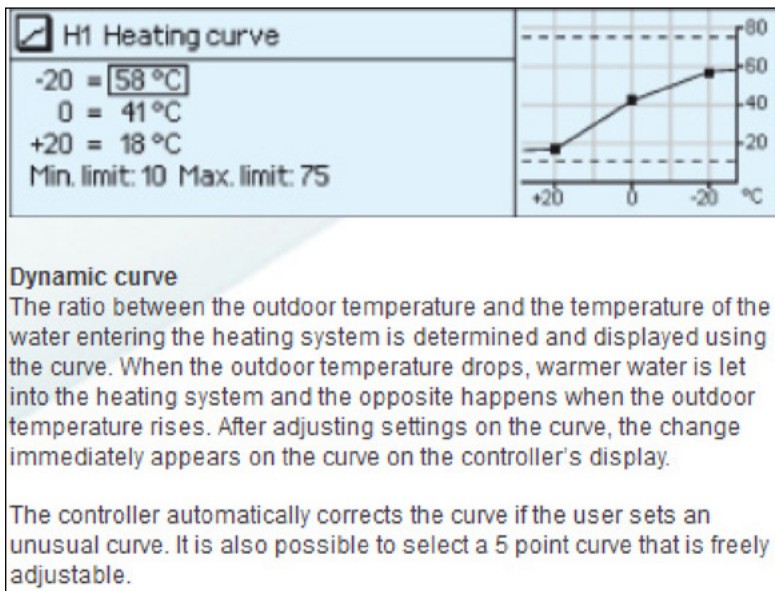

Picture 39. Dynamic heating curve

/26/ Below is picture of Ouman EH-800, Ouman’s latest edition of heating regulators, operating principle. Ouman company has over 20 year experience in temperature regulator manufacturing. The EH-80, which is predecessor of EH-800, is used in over 100 000 Finnish homes. EH-800 is the latest edition of Ouman’s heating regulators.

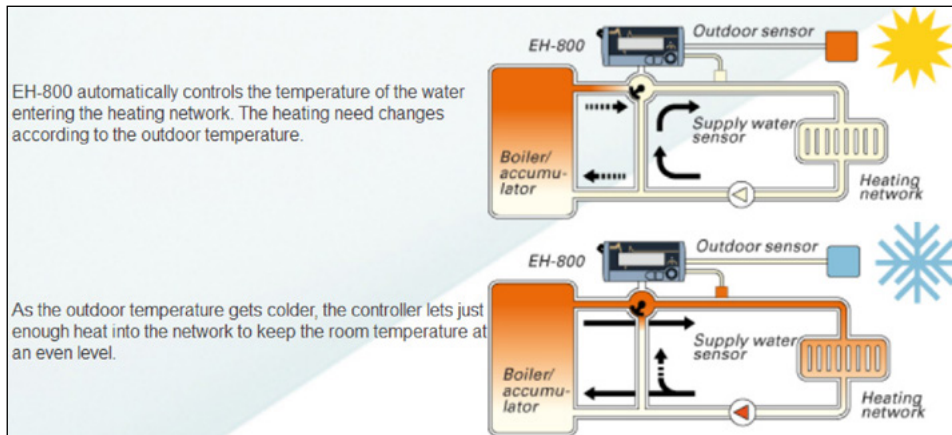

Picture 40. Heating regulation using Ouman EH-800

Ouman EH-800 is suitable for hybrid heating when it is equipped with an EXU-800 external unit. With this external unit the controller can expand to control two heating sources simultaneously, so that energy is always taken from the most profitable source. With this unit it is also possible to control second heating circuit, for instance damp rooms can be heated separately. Operation principles can be seen in the following images.

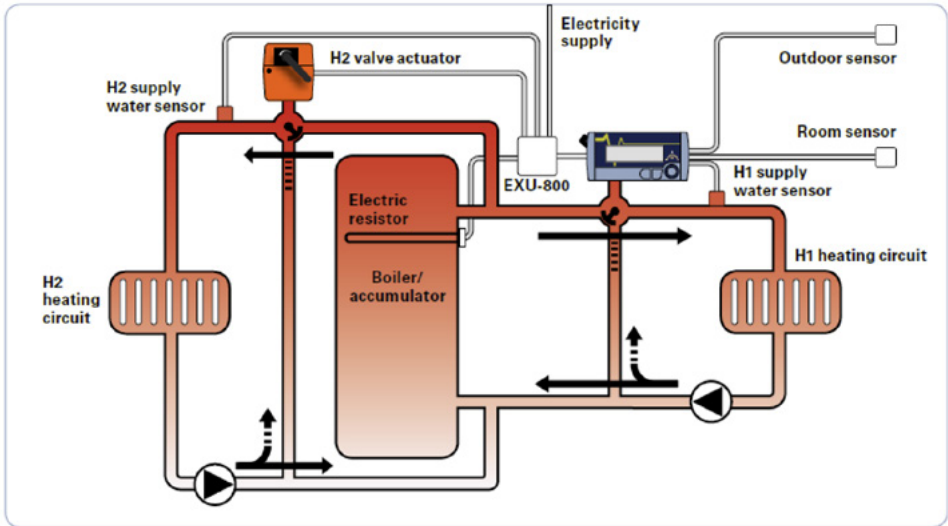

A basic diagram for connecting two heating circuits. The controller controls both heating circuits on the basis of the same outdoor temperature measurement but different supply water temperature measurements. Each heating circuit has its own curve and other settings that effect control.

Picture 41. Basic diagram for connecting two heating circuits

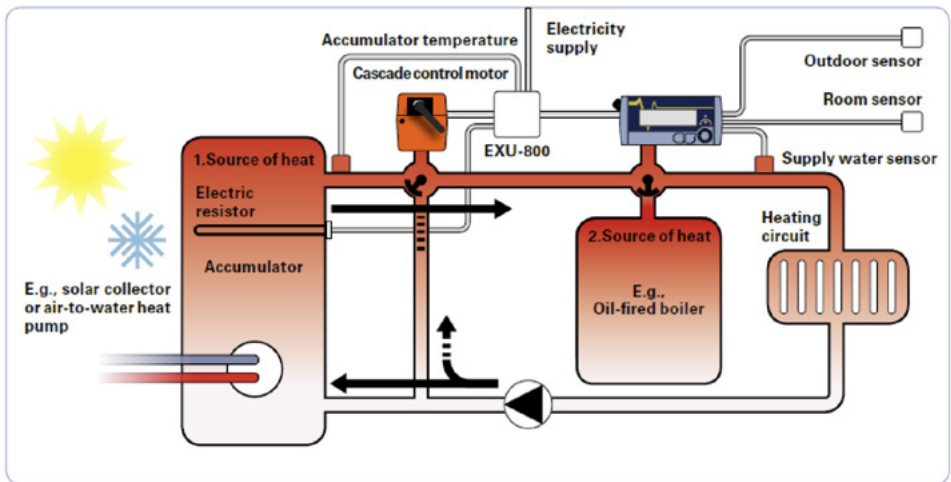

A basic diagram for hybrid heating, with the cascade control actuator getting its power from the first source of heat. When the power is depleted from first source of heat, the controller begins taking additional power from the second source of heat. The surface temperature sensor measures the temperature of the accumulator (1. heat source)

Picture 42. Basic diagram for hybrid heating

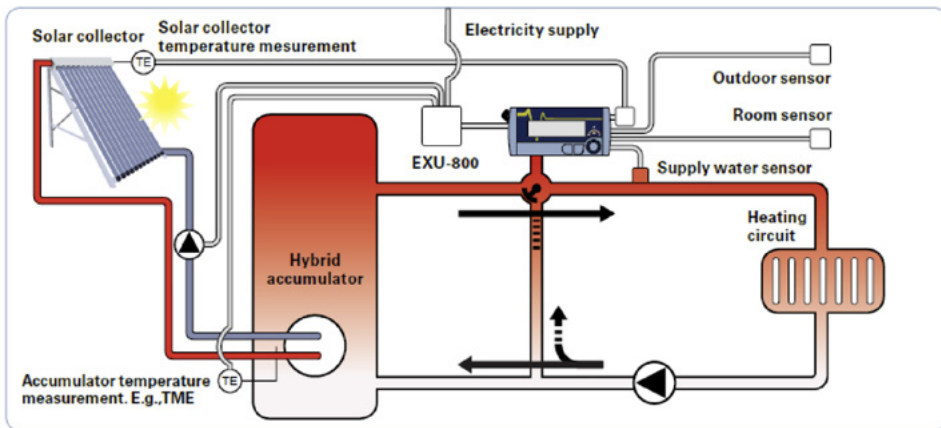

Basic diagram of hybrid heating, with the heating controller controlling the charging pump between the solar collector and accumulator and controlling the heating system according to the outdoor temperature and supply water temperature.

Picture 43. Basic diagram for hybrid heating

Individual room temperature control is carried out in the radiator based heating systems with thermostatic valves placed between radiators and inlet water pipes. Thermostatic valve adjusts water flow through the radiator based on the room temperature. In the water radiant floor heating individual room temperature is controlled by room thermostat. Room thermostat measure the temperature of the room and control the valve which adjusts the water flow in the room's floor.



Picture 44. Ouman room thermostat.

6.2.1 Outdoor temperature sensor placement

Outdoor temperature sensor should be placed on the north side of the house. Sensor must be protected from sun thermal radiation, ventilation air and other similar factors which can affect the result of measurement.

6.2.2 Room temperature sensor placement

Measuring room temperature is more complicated than commonly assumed. For instance, in the heating season radiators send thermal radiation which can affect the measurement result. In this case, temperature sensors measure the average of the room temperature and thermal radiation instead of only the room temperature. Other things that affect the measurement result are the coldness of outer walls etc. For these reasons temperature sensor placement should be properly designed.

6.3 HEAT DISTRIBUTION SYSTEMS

In central heating the heat is produced in one location and then distributed to places of use by medium. Medium can be water, air, steam, oil or water-glycol mixture. In single family houses the mostly used medium is water. In water-based systems heat is kept in the water charger (district heat needs only the heat exchanger). Heat can be produced for instance by oil, pellets, wood, ground heat, electric etc. From water charger heat is transferred by the heat exchanger to medium which transports the heat by circulation pump to radiators or to underfloor pipes if using radiant floor heating. There some of the heat of the water is released to surrounding space or material. Hence water returns back to water charger to collect heat once again.

6.3.1 Water radiator heating

/28/ Radiator heating is a traditional way to execute the water central heating. Most common system is so called two pipe system, where heated water and return water flows in their own pipes. In modern radiator heating pipes are made out of oxygen diffusion protected plastic placed in the structures of the house so they are out of view. Pipes are surrounded by protective tube, so they are replaceable. Other used pipe materials are black steel, copper, thin-walled Mapress –steel pipe and composite pipe.

RADIATORS

/28/ Radiators are usually placed on the outer (cold) wall of the room, preferably under the window. When radiators are located under the window, cold air coming through the window is mixed with the warm air coming through the radiator and therefore it does not flow directly to the floor level and cause draught problems.

TEMPERATURE CONTROL

/28/ In water radiator heating temperature adjustment is based on the temperature of the outside air. Temperature of the water circulating in the radiator network is adjusted by the information received from temperature sensor outside. In the rooms temperature can be adjusted by thermostatic valves placed between the radiator and incoming pipe. In the picture below is Ouman EH-800 temperature controller curve for temperature adjustment. Curve can be modified if needed.

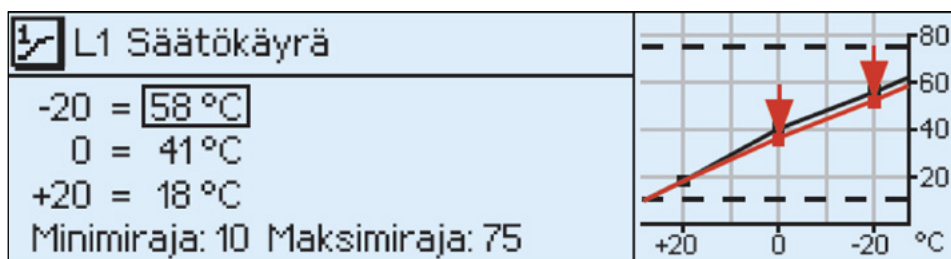

Picture 45. Ouman EH-800 temperature controller curve for temperature adjustment

6.3.2 Hydronic radiant floor heating

/28/ Hydronic radiant floor heating is the most common method of heat distribution in the new single family houses in Finland. In year 2008 water floor heating was elected as a heat distribution method in 60 % of new single family houses.

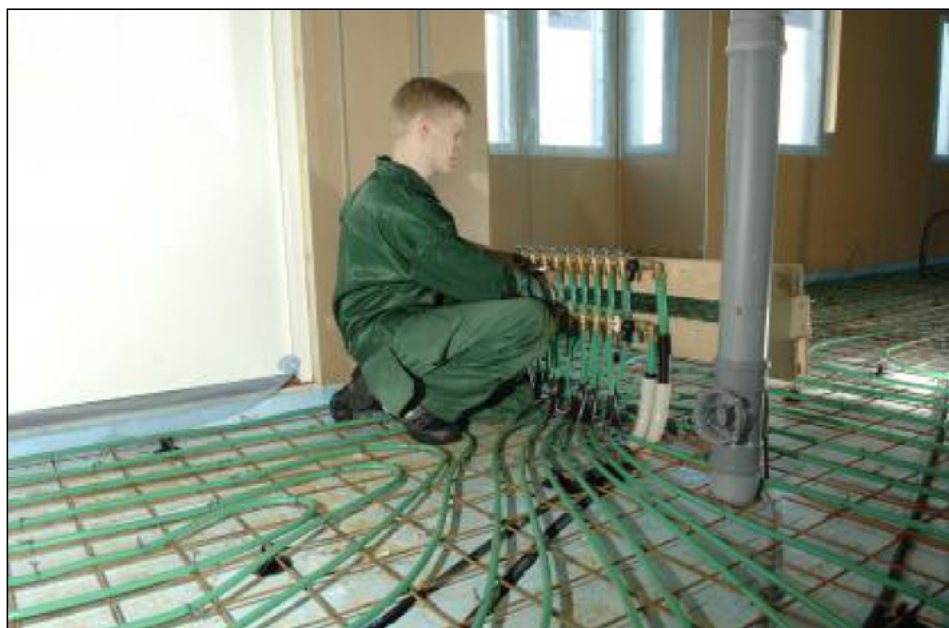

Picture 46. Installing the hydronic radiant floor heating

OPERATION PRINCIPLES

/28/ Warm water circulates in tubing installed in the floor structure. Method is suitable with concrete and wood-structure floors. Hydronic radiant floor heating is suitable in every room and almost with every surface material. In wet rooms is reasonable to install separate tubing loops, thus rooms can be heated separately throughout the summer. Temperature of the water circulating in tubes can be lower than in radiator heating, usually about 40 °C max, so heated water is easier to produce for instance with heat pump. Temperature of the water circulating in the pipe network is adjusted by the outdoor temperature. Individual room control happens with room thermostat which adjusts the manifold valve.

6.3.3 Air heating systems

/30/ In air-circulating heating systems heat is distributed to room spaces along with the air. At the moment the market share of air-circulating heating system in new single family houses in Finland is rather small.

/30/ AIR RADIANT FLOOR HEATING

In the air radiant floor heating air ductwork are installed into the floor casting. Air circulating in the tube network heats the floor, from where heat moves into the room air. Heating energy can be for example electric, ground source heat, district heat etc.

/30/ AIR HEATING

In traditional air heating air is centrally heated and the distributed into the rooms via vents located in floor front of windows. Air is heated with electricity or water heat exchanger, when heat source can be freely chosen.

/30/ VENTILATION HEATING

Ventilation heating combines heating and ventilation. It is suitable for primary heating system especially for low energy- and passive energy houses. Supply air flow is dimensioned by the need for ventilation. Supply air is first pre-heated centrally in the ventilation unit. Additional heating is controlled by the room thermostat, which adjusts the heating element (electric resistor) in inlet vent. This additional heating is possible only in rooms with supply air. Rooms, from where ventilation air is removed e.g. in damp rooms, additional heating must be implemented in some other way, for instance with underfloor heating cable.

6.3.4 Direct electric heating

/30/ In direct electric heating heat is produced with electric resistors as required. There is a few different ways to implement direct electric heating.

ELECTRIC RADIATORS

Radiators are usually installed under the windows. Room thermostats control heating precisely and electric radiators react fast to heating demand fluctuations. Heat is produced in space which is supposed to heat, thus the efficiency of radiator heating is high.

ELECTRICAL FLOOR HEATING

In this heating method heating cable is placed into the floor structure. If floor structure has ability to storage heat (e.g. concrete plate) , it can be heated with cheaper night-electric.

6.4 HEATING SYSTEMS FOR SFHS (SINGLE FAMILY HOUSES)

In this section of the report is a short description of heating and ventilation technology suitable for single family houses.

Heating systems can be divided in two categories: primary heating systems and secondary heating systems. Primary heating systems can cover all the need of heating (including hot water) year around. Secondary heating systems can't cover the all need but they can act as a support system beside of the primary system.

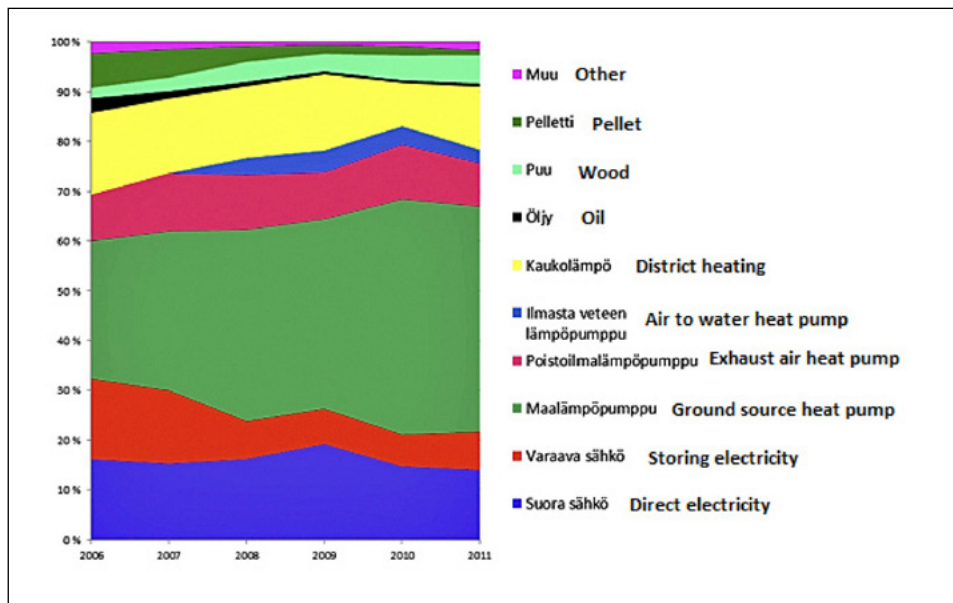

Picture 47. Usage of different energy sources between 2006 and 2011

6.4.1 Primary heating systems

DISTRICT HEATING

/32/ An international study co-financed by the European Commission confirms, that it's possible to save an extra 400 million tons of CO₂ yearly with more district heating and cooling across 32 European countries. District heating and cooling plays a great role in the supply of low-carbon heating and cooling particularly in North, Central and Eastern Europe, where market shares often reach 50 % and more. On average, over 80 % of heat supplied by district heating originates from heat recovery or renewable energy sources (i.e. from electricity production or industrial processes).

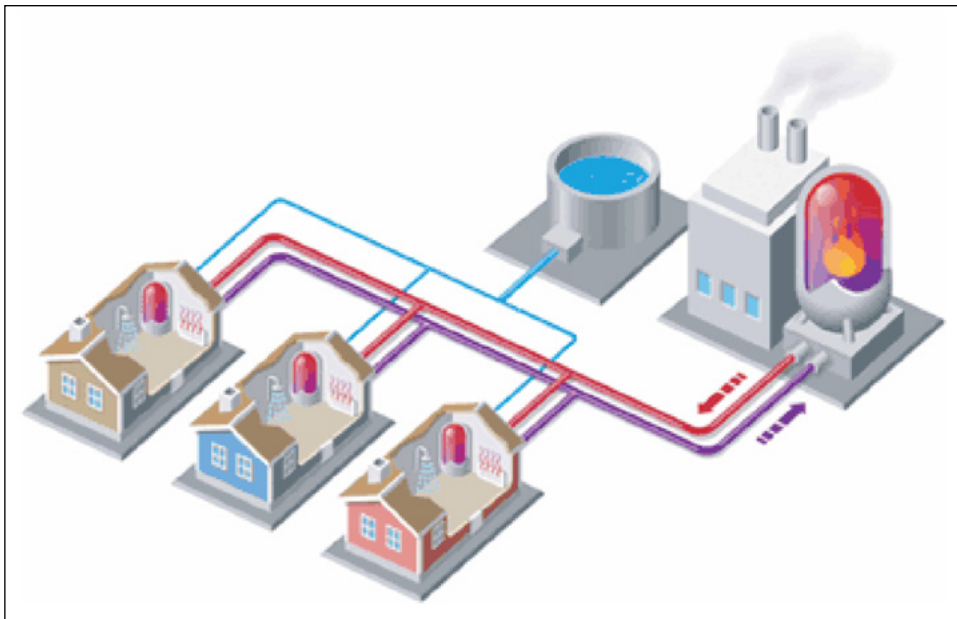

Picture 48. Basic principle of district heating

WHAT IS DISTRICT HEATING

/33/ District heating is a convenient way to heat buildings and hot water. In many processes, for example generating electricity or burning waste, large amount of the energy are set free in the form of surplus heat. The basic idea in modern district heating is to recycle this surplus heat which otherwise would be wasted- from electricity production, from fuel and biofuel-refining, and from different industrial processes. Moreover, district heating can make use of the many kinds of renewables (biomass, geothermal, solar thermal).

HOW DISTRICT HEATING WORKS

/32/ The recycled heat is used to heat water which is carried to the customer via a well-insulated network of pipes. District heating can serve residential, public and commercial buildings. A heat exchanger operates as an interface between the district heating network and the building's own radiator and hot water system. There's no boiler or the burning flame needed in the house and maintenance is taken care of by professionals.

COSTS OF DISTRICT HEATING IN FINLAND

/34/ The average price for district heating to single family houses in Finland is about 75 €/MWh. Fee when single family house joins to the district heat network in Finland is about 3 000 €, however, the price range varies between companies.

DISTRICT COOLING

/32/ District Cooling is an environmentally optimized cooling solution, which uses natural resources to generate cooling where and when it is needed. The customer is connected to the cooling source via a pipe network. Cooled water is distributed to the buildings where it loses its cold content, thus cooling down the building temperature.

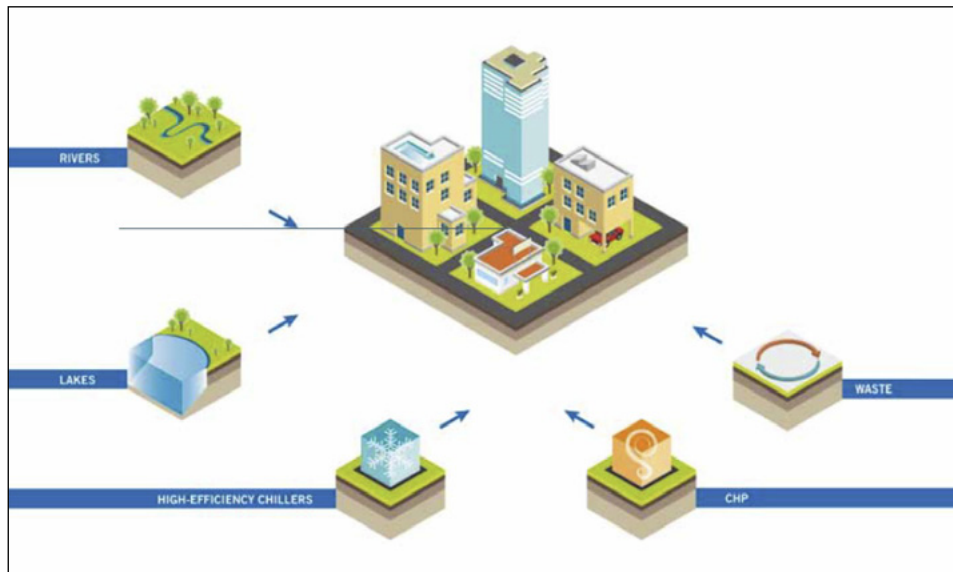

Picture 49. District cooling

PROS AND CONS OF DISTRICT HEATING

- + renewable (depending on what fuel district heating plant use)
- + CHP (combined heat and power) –plants operate at high efficiency
- + hydronic heat distribution allows exchange the heating system
- not available everywhere
- dependence on one energy supplier

GROUND SOURCE HEAT PUMPS

/35/ When using geothermal energy as a heat source, the heat is collected with ground source heat pump which uses pipes located in the ground or water system (lake, pond, river) to extract heat. Collected heat can then be used to heat radiators, underfloor or warm air heating systems and hot water in your house. Ground source heat pump circulates a mixture of water and antifreeze around a loop of pipe – called a ground loop. Heat from the ground or water is absorbed into the fluid and then passes through a heat exchanger into the heat pump. The ground stays at a quite constant temperature under the surface, so the heat pump can be used around the year – even in the middle of winter.

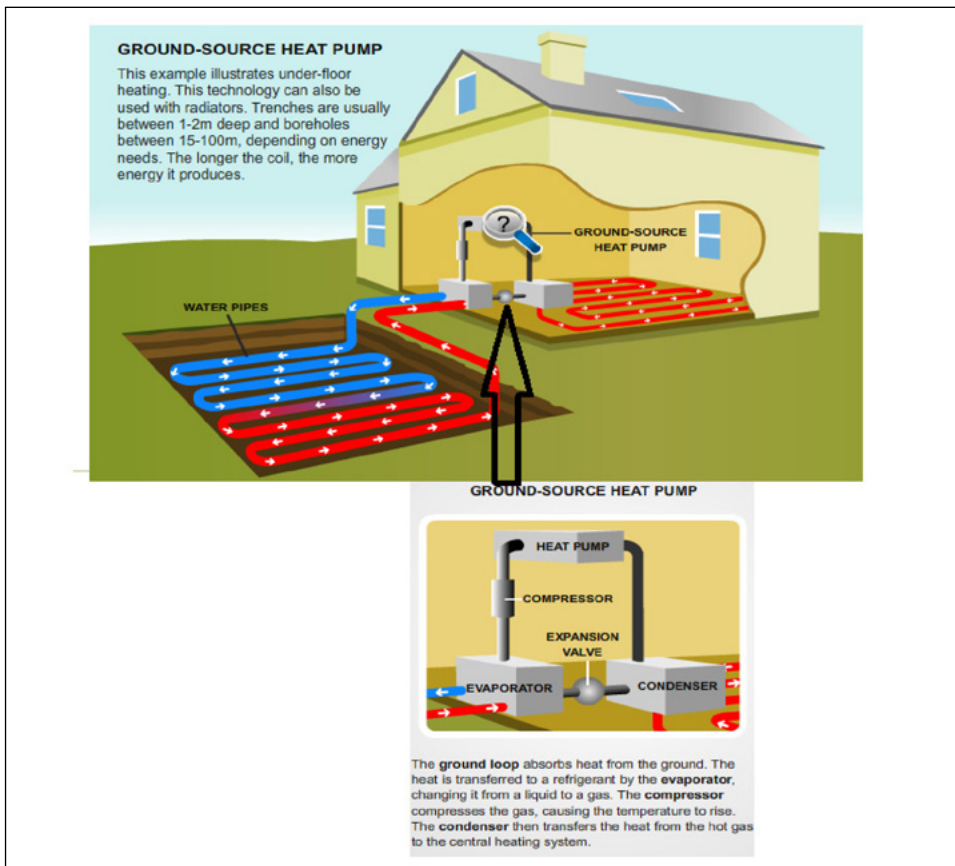

Picture 50. Ground source heat pump

HOW GROUND SOURCE HEAT PUMP WORKS

/35/ Heat from the ground or water is absorbed at low temperatures into a fluid inside a loop of pipe (a ground loop) buried underground or embedded into the water. Then the fluid passes through a compressor that raises it to a higher temperature, which can then heat water for the heating and hot water circuits of the house. The cooled fluid passes back into the ground or water where it absorbs further energy in a continuous process as long as heating is required.

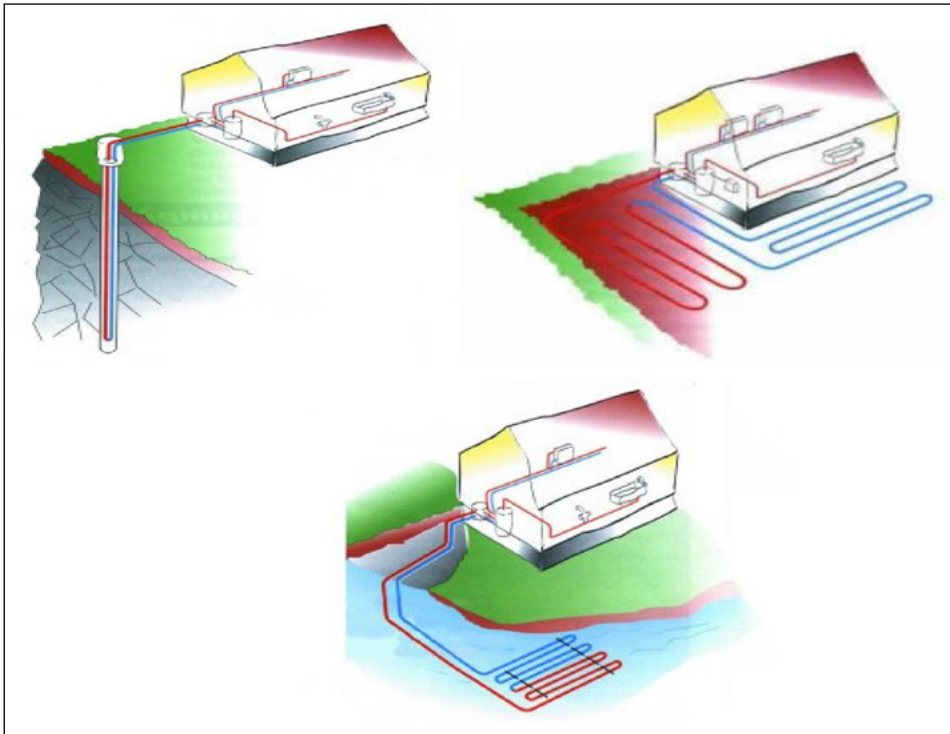

Picture 51. Ground source heat pump

INDICATIVE PRICE AND EFFICIENCY OF GROUND SOURCE HEAT PUMP SYSTEM

Ground source heat pump system is quite expensive to purchase. In Finland ground source heat pump costs about 5 000-7500 € + installing / borehole drilling etc. which costs about half of the total price, so it is important to make exact calculations to see if it is the best choice available. The payback time can be longer than systems life cycle, especially if the house is comparatively small, well-insulated and air-tight. /35/ Ground source heat pump can perform better with underfloor heating systems or warm air heating than with radiator-based systems because of the lower water temperatures required. Ground source heat pump's COP (coefficient of performance) is about 3, thus it generates heat 3 kWh per every used electric kWh (www.motiva.fi).

PROS AND CONS OF GROUND SOURCE HEAT PUMP

- + renewable energy
- + thermal energy production is relatively inexpensive
- + can also be used for cooling
- + does not necessarily need technical room
- + hydronic heat distribution allows exchange the heating system
- comparatively expensive to purchase

AIR TO WATER HEAT PUMP

/37/ Air to water heat pumps use the heat of the external air to heat up water in the house heating and/or hot water system.

HOW AIR TO WATER HEAT PUMP WORKS

/37/ /38/ The external air is cooled by passing over a heat exchanger installed outside of the house. This is connected in a closed system containing refrigerant that is able to turn into a gas at low temperatures. When the external air goes through the evaporator the refrigerant will turn into a gas. After that, using a compressor, the gas reaches a high enough temperature to be transferred in the condensor to the house's heating system. At the moment the refrigerant reverts to liquid form, ready to turn into gas once more and to collect new heat. When using a inverter-driven heat pump compressor, the system can be regulated so that heat output matches with capacity needed at any given time.



Picture 52. Air to water heat pump

INDICATIVE PRICE AND EFFICIENCY OF AIR TO WATER HEAT PUMP SYSTEM

Air to water heat pump system is almost as expensive as ground source heat pump but installing is easier and cheaper. Air to water heat pump always needs a backup system (e.g. electrical resistance heating) at least in Northern Europe, because pump's

performance gets low when temperature goes hard freezing conditions. Air to water heat pump's COP (coefficient of performance) is about 2, thus it generates heat 2 kWh per every used electric kWh.

PROS AND CONS OF AIR TO WATER HEAT PUMP

- + suitable for any construction site
- + cheaper than ground source heat pump
- + hydronic heat distribution allows exchange the heating system
- quite expensive
- lowest operating point is about -25 °C

EXHAUST AIR HEAT PUMP

Exhaust air heat pump collects energy from the warm inside air as it leaves via ventilation system, and re-uses it to heat up hot water, house heating water or fresh incoming air.

HOW EXHAUST AIR HEAT PUMP WORKS

/39/ Exhaust air heat pump extracts air via ventilation ducts which are positioned in the wet rooms of the house. On its way out of the house, heat is extracted from the exhaust air and transferred into the heat pump's refrigerant circuit. The exhaust air is then discharged. Then, the vapour compression cycle of the heat pump raises the temperature of the refrigerant and transfers the collected heat into a water-based system that can warm up the hot water or/and heat the building. An exhaust air heat pump can take care of the house's heating requirements of a well-insulated house in all but the coldest conditions.

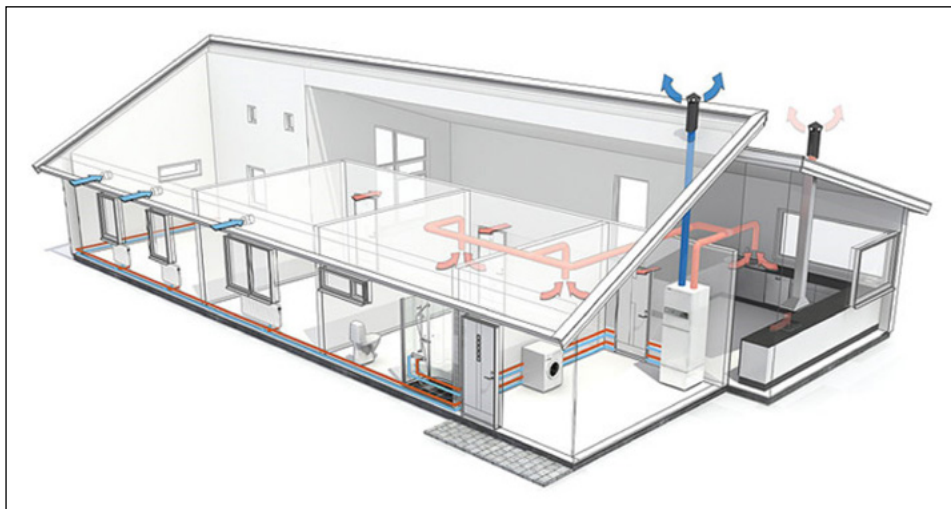

Picture 53. Exhaust air heat pump

INDICATIVE PRICE AND EFFICIENCY OF EXHAUST AIR HEAT PUMP SYSTEM

Price range of the exhaust air systems is quite wide, due to the desired features of the system. Basic models cost about 3 000 € in Finland. Models with better features can cost twice as much. When using exhaust air heat pump, can be achieved 40 % savings compared to using only direct electric heating.

PROS AND CONS OF EXHAUST AIR HEAT PUMP

- + same device takes care of ventilation, hot water and heating
- + cheapest primary heat pump solution
- lower efficiency than other heat pump systems

WATER FIREPLACE

There is couple of systems to take heat out of fireplaces and use it for house heating and/or hot water heating. In one solution, water, which operates as a heat broker, circulates in the shell of the chimney and collects heat from the flue gases. In other solution, water circulates in the frame of the fireplace or there's a cistern in it.

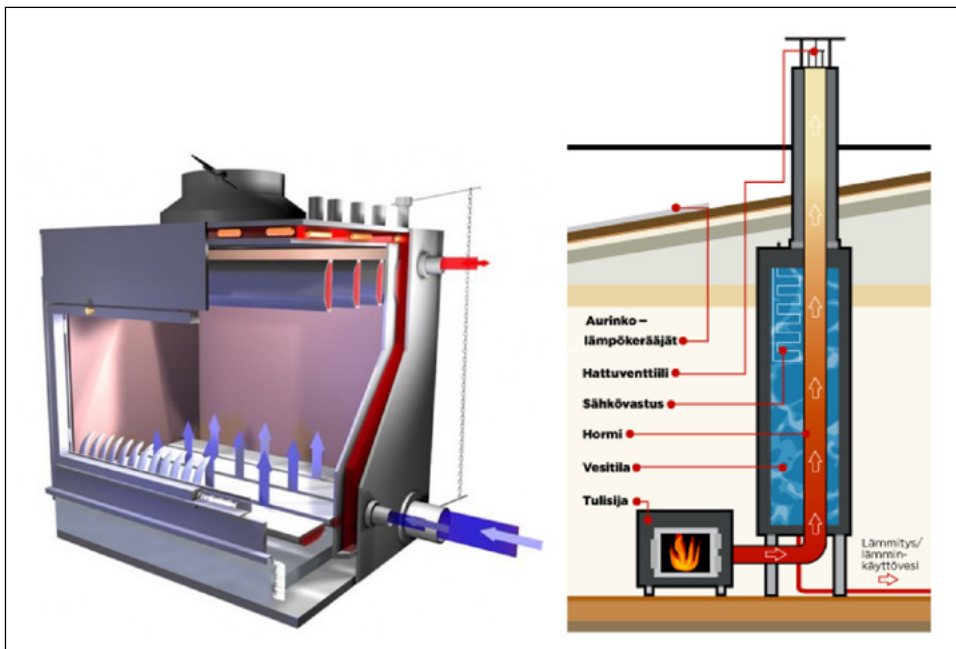

Picture 54. Water fireplace

HOW WATER FIREPLACE WORKS

Water fireplace is connected to the house's water charger, from where the heat is distributed wherever needed (house heating or hot water). Automation controls the operations. Because system needs electric to circulate water, it can be equipped with batteries, or connected to aggregate in case of power failure.

Talteenotto­piipun toimintaperiaate LTOP-219

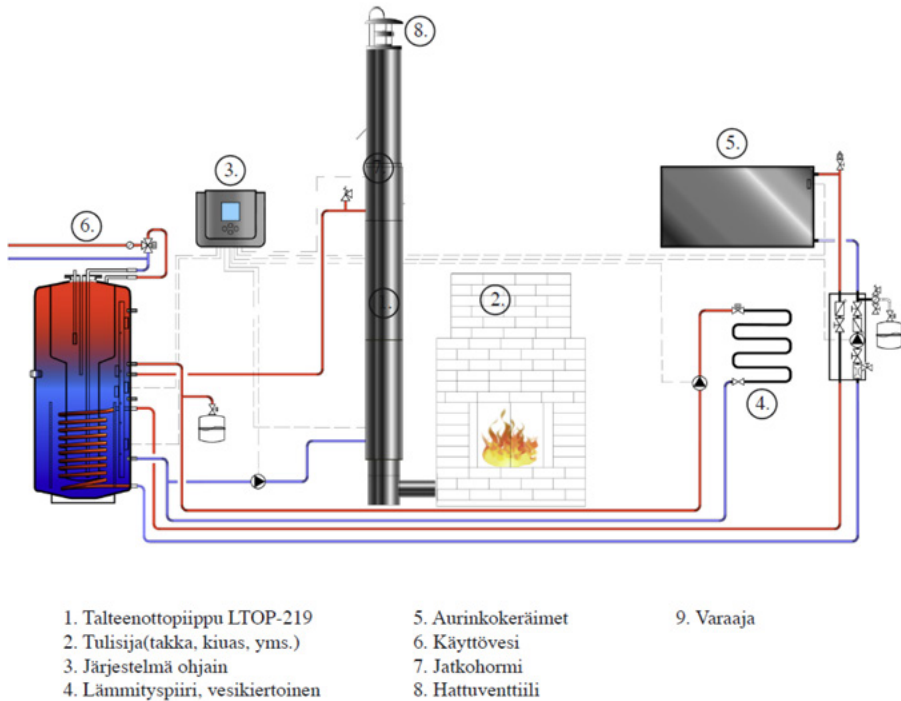

Picture 55. Heat recovery from the chimney

INDICATIVE PRICE OF WATER FIREPLACE

Prices of the simplest water fireplaces systems starts about from 1 000 € + installation, masonry fireplace etc. Some dealers sell systems with better features which includes for example solar thermal system etc. In that case price can rise thousands of euros.

PROS AND CONS OF WATER FIREPLACE

- + if sufficiently dimensioned can operate as an primary heating system
- lot of work if used as an primary heating system

WOOD PELLET HEATING

/43/ The environmental load of the wood pellet heating is very low. Pellets are usually made of sawmilling or wood industry waste, and are thus renewable. Pellet heating fits a in new or urban renewal building when using water based central heating, and can replace old oil/wood heating system.

/44/ Wood pellet heating systems typically have following components: a burner, a bulk-storage unit (hopper), a pellet conveyor (auger) and a controller that automates the system. Operating principle can be seen in the figure below.

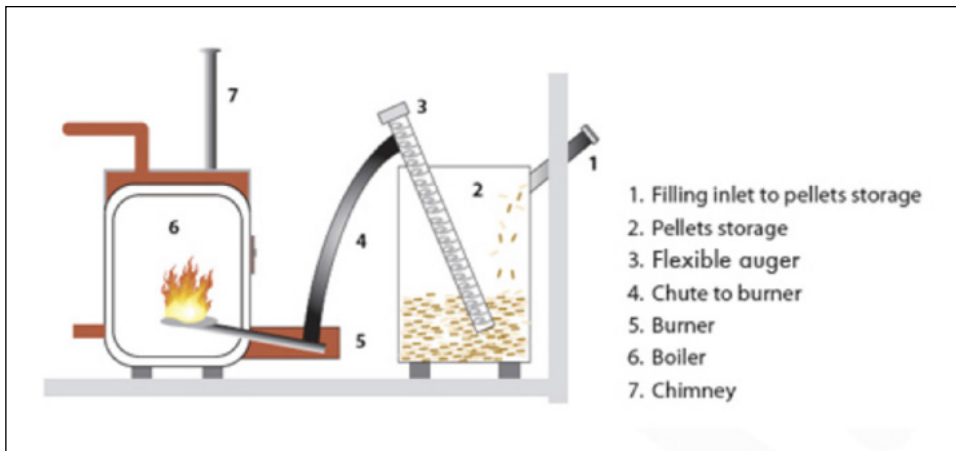

Picture 56. Wood pellet heating system

/45/ /46/ Energy content of the pellets is large for a wood-based fuel. One square meter of pellets contains same amount of energy than about 300 liters of light fuel oil and it costs about 250 € in Finland. Suitable size of the pellet storage unit for single family house is about 8 m³, which can accommodate pellets for one year.

PROS AND CONS OF THE WOOD PELLET HEATING

- + domestic renewable energy
- + stable price
- + pellet store can be built by yourself
- requires a separate technical room / space
- requires storage place for pellets
- requires regular maintenance if automation not included
(automation increases price)

ELECTRIC HEATING

/47/ Electric heating continues to be one of the most popular form of heating in new single-family houses. It is easy to use and cost-efficient form of heating, because it does not need any expensive investments or complicated maintenance measures. There are several alternatives available for the implementation of electric heating. The most common form of electric heating, with the most advantageous investment costs, is direct electric heating where the distribution of heat is carried out in most cases by means of electric radiators or underfloor heating system. In this case, a water heater

is needed for domestic hot water, and its size and output are selected according to the need. The energy efficiency of a house with direct electric heating can be improved by for instance air heat pump. Electric heating based on the distribution of heat with water circulation is more expensive than the direct electric heating, however, a more versatile option. The advantages of central heating with water circulation include the possibility of changing the source of heating energy and the chance of connecting different sources of energy in parallel.

PROS AND CONS OF THE STORING ELECTRIC HEATING

- + hydronic heat distribution allows exchange the heating system
- + easy to use
- price of electricity

PROS AND CONS OF THE DIRECT ELECTRIC HEATING

- + cheap to invest
- + high efficiency
- + precise adjustment
- price of electricity
- difficult / expensive to change afterwards

OIL HEATING

/48/ Oil heating with its long tradition still is an easy and convenient heating method even today. New innovations such as the development of burner and other equipment technology have reduced the oil consumption in heating, compared with the old systems. Technological development and use of fuel oil with reduced sulphur content have also significantly reduced the overall emissions of oil heating. The nitrogen oxide, sulphur dioxide and particle emissions of oil heating are slight in comparison with many other forms of heating energy. Heating oil contains already now a bio oil share, which reduces carbon dioxide emissions. Bio oil share is continuously increased. Oil heating also suits for the Finnish energy production, because it does not load the national electric power network during the peak periods.

PROS AND CONS OF OIL HEATING

- + modern boilers and burners operate at high efficiency
- + biocomponent containing liquid fuels available
- + hydronic heat distribution allows exchange the heating system
- economic situation affects on the fuel price
- fossil fuel

6.4.2 Secondary heating systems

SOLAR HEATING

/49/ In northern Europe solar energy is best suited for a supplementing form of energy. In Finland it is possible to utilize solar energy for heating from the beginning of February until November. Usually solar heat is used for the production of hot water but it can also act as a additional house heating system.

HOW SOLAR ENERGY IS COLLECTED

/49/ The utilization of solar energy takes place by means of various technical devices. Solar heat is obtained when the solar radiation is transformed into heat in solar collectors which can be plane or vacuum pipe model. In the collector circulates non-freezing heat transfer liquid by means of a pump. The heat of the liquid is that has been heated in the collector is transferred via a heat exchanger to the heat charger. As a whole, the solar heat system consist of solar collectors, a pump, a heat charger, control unit and the pipes.

INDICATIVE PRICE AND EFFICIENCY OF THE SOLAR THERMAL SYSTEM

/49/ /50/ One square meter plane solar collector generates usually 250-400 kWh energy per year. Vacuum pipe collectors are more efficiency than plane collectors. System sized 8-12 m², which is suitable for single family house costs about 4 000-5 000 € installed in Finland. Solar heat is usually used for the production of hot domestic water; it, however, can be made even greater use of, if solar collectors are also connected to a water circulation heating system. Approximately half the energy needed for producing hot domestic water can be generated by means of solar heat. If solar collectors are connected to the heating system, even 25-35 % of the required heat can be covered by means of solar heat. In case of low energy and passive houses the share is even bigger due to smaller need for heating.

SOLAR ELECTRICITY

/51/ Solar panel electricity systems, also known as solar photovoltaics (PV), capture the sun's energy using photovoltaic cells. These cells don't need direct sunlight to operate – they can still generate some electricity on a cloudy day. The cells convert the sunlight into electricity, which can be used to run household appliances and lighting

PROS AND CONS OF SOLAR THERMAL HEATING

- + can be used to warm up hot water, house heating or electricity production
- low efficiency in the winter time, can act only as a additional heating system

AIR HEAT PUMP

/63/ Air heat pump is the most economical heat pump solution. Air heat pump transfers heat energy from the open-air delivering it directly to the inside air. Thus an air heat pump suits well for a heating method supplementing electric, oil heating etc.,

reducing the heating costs. An air heat pump can also be used for cooling the indoor air in summer.

INDICATIVE PRICE AND EFFICIENCY OF AIR HEAT PUMP

/52/ The price and quality of the air heat pumps varies widely. Prices starts from about 700 € and the most expensive models cost many times more. Air heat pump can produce about 30-40 % of single family house heating needs, if circumstances are optimal. Due to R&D, the performance of air heat pumps has improved and best models work efficiently even -20 degrees.

- + comparatively low investment
- + can also cool indoor-air
- efficiency drops when outside air temperature gets lower
- lot of work / attention

7 Ventilation and Air Conditioning

The purpose of ventilation is to take care of the air quality in the house. It carries out the old stale air and takes in the fresh and healthy air. Nowadays when insulation of the houses gets thicker and houses are built air-tight, the importance of well-functioning ventilation is highlighted. If ventilation does not work properly, it can lead to air quality and moisture problems in the building. It's important, that the designing and installing of ventilation is implemented with care and high quality.

At present, the most appropriate system for single family house ventilation is balanced ventilation with heat recovery. In the single family houses most useful way to manage ventilation is to use ventilation unit. It is a compact package containing all necessary actions and phases like heat recovery, anti-frost etc. Finnish building code insist that in the new single family houses yearly efficiency of the heat recovery is at a minimum 45 %.

Air used in ventilation can be treated in several ways. Air can be filtered, heated, cooled, moistened and it can be mixed with some room air and finally part of the heat is transferred from exhaust air to supply air with heat recovery. Every of the above mentioned can be used simultaneously singly. At minimum ventilation system should contain filters, supply air heating system and heat recovery.

DEFINITION OF AIR CONDITIONING

In the broadest sense air conditioning can refer to every form of cooling, heating, ventilation or disinfection that modifies the condition of air, usually for thermal control. More commonly term air conditioning is used when it comes to cooling and often dehumidification of indoor air, typically via refrigeration. An air conditioner is an appliance, system or mechanism designed to extract heat from particular area using a refrigeration cycle. Most commonly modern air conditioners are used for comfort cooling in buildings and transportation vehicles.

AIR CONDITIONING (COOLING)

It is questionable to say is there real need for actual cooling in single family houses especially in northern Europe. There is just a few days in a year when temperature rises to heat degrees, so it may not be reasonable to do expensive investments to cooling system. Often with good designing, materials etc. it is possible to prevent or

decrease excessive heat gain in the house. When purchasing heat pump system, there is usually at least with little extra cost opportunity to use it for cooling as well. The most inexpensive choice to cool single family house is air heat pump, which can be used both, cooling and heating, with no extra cost. If ground source heat system with borehole is chosen as a heating system, effective cooling can be executed by fan coils where circulates ground loop liquid. Also air-to-water heat pumps are available with supply air cooling option. Heat taken from the indoor air can be used for example to pre-heating of domestic water. Always when cooling air, there is possibility that humidity in the air condenses into water, which can cause various problems if it is not have be taken into account in designing.

VENTILATION IN WET ROOMS

/53/ The importance of well-functioning ventilation in wet rooms is very high, because in those rooms usually are lot of sources of moisture like shower, washing machine, sauna etc. plus additional moisture comes from other rooms when air is removed from the damp rooms. For instance when drying laundry in wet rooms, it may release several kilograms water in the surrounding room air. If simultaneously other sources release moisture in the air, humidity-level easily raises over 60 %, which is the risk limit for mold growth etc., even if ventilation operates in 1/1-power. Hence it might be good to measure humidity-level in the wet rooms of the house and use the info for ventilation control.

7.1 VENTILATION SYSTEMS

7.1.1 Balanced ventilation

/54/ The most complete system for ventilation is the balanced ventilation system with heat recovery. Nowadays when need and importance of the heat recovery is highlighted, balanced ventilation with heat recovery is practically the only option for ventilation system. In a supply and exhaust air system with heat recovery the supply air vents are positioned in living rooms and bedrooms and the exhaust air vents in the bathroom, toilet and utility room. This system makes use of the heat in the exhaust air, heat that would otherwise be released straight out into the cold. The heated indoor air passes through a heat recovery unit before being released and is used to heat the incoming outdoor air. This saves energy while providing a better climate indoors. Balanced ventilation makes possible to control the air quality and the air volume coming into the home, compared i.e. to mechanical exhaust air ventilation. Balanced ventilation systems also have effective filters, which filter out dust and pollen from the outdoor air.

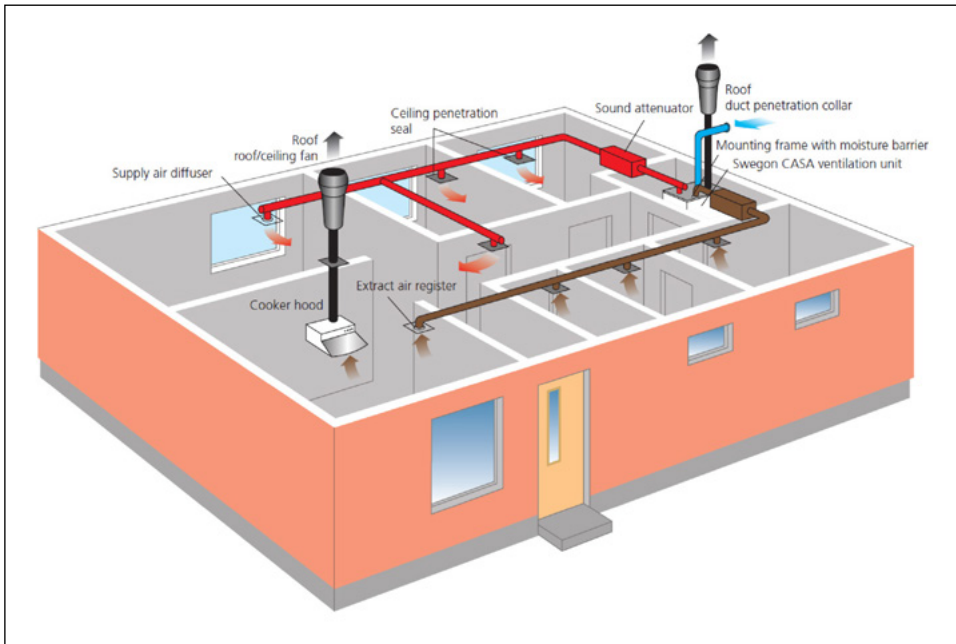

Picture 57. Basic function of a balanced ventilation system

7.1.2 Ventilation unit

Modern ventilation unit is a versatile device with number of basic features and if wanted with accessories. For instance Vallox 150 Effect SE –ventilation unit contains following features summer/winter automation, 8 position power adjustment, high efficiency cross-counter flow heat recovery cell, electric of liquid-circulating supply air pre-heating, week clock control, ground source heat equipment in MLV model, maintenance reminder, fireplace / booster switch function, fixed air flow measurement outlets, supply- / exhaust air ratio control, option for humidity / carbon dioxide control (optional) etc. In next picture is operation principle of ventilation unit.

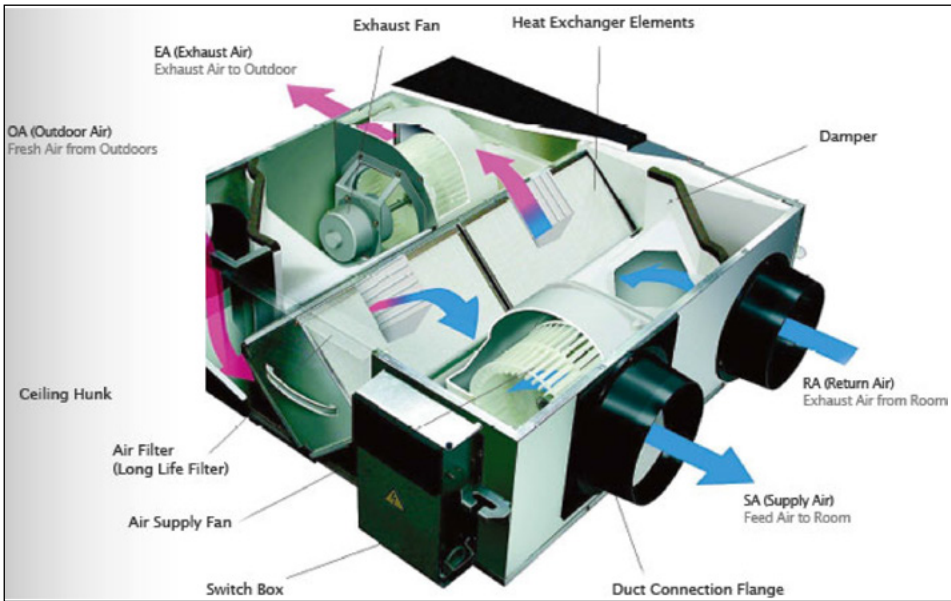

Picture 58. Vallox 150 Effect SE MVL R –ventilation unit functions



Picture 59. Vallox 150 Effect SE MVL R –ventilation unit

VENTILATION CONTROL

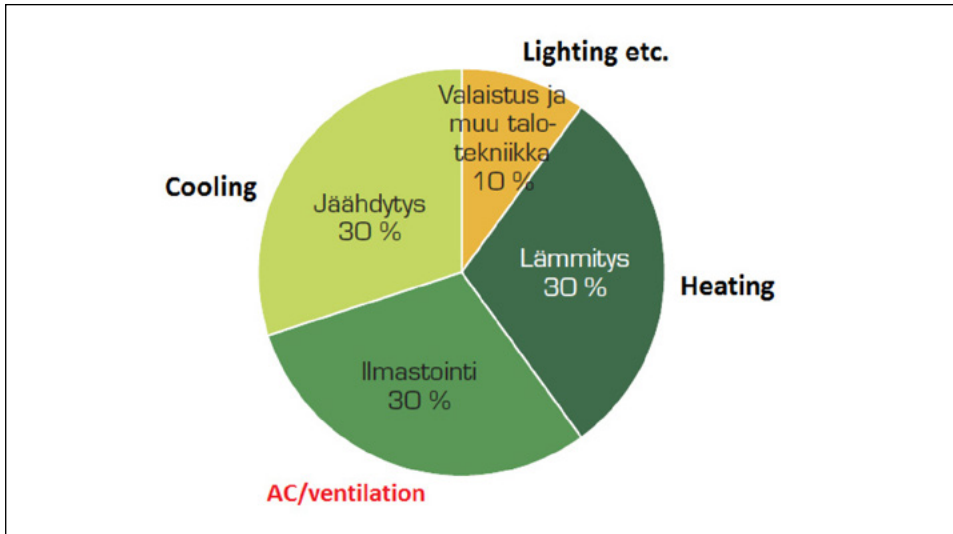

Picture 60. Buildings energy consumption on average in the EU

Ventilation is one of the biggest energy users in the single family house, thus it is reasonable to change air only as required.

/55/ Ventilation units are often equipped with four separate operation modes.

Mode 1:

- When house is empty.
- May not be sufficient when the laundry is left drying etc.

Mode 2

- One or two persons in the house.
- Drying laundry left in the empty house.

Mode 3

- Normal mode to achieve the design air volume.
- Several persons in the house.
- Wet room drying shower etc.

Mode 4

- Enhanced position
- Smoky smell extraction while cooking etc.
- Sauna

Even empty house needs low ventilation, because interior materials and house structures releases contaminants in the room air. When house is inhabited, ventilation needs addition to the above, take care of increased humidity, carbon dioxide etc. Current rule of thumb for ventilation is 0,5 1/h which means that the amount of air contained in the house has to be changed every two hours when residents are present, and this should achievable with about 40 % power of ventilation unit so that the operating point of unit is optimal in terms of efficiency and ventilation can also be enhanced when needed.

SUPPLY AIR HEATING

/55/ Supply air temperature should be set correctly. Suitable temperature for it is about 15-17 °C if it is not only heating system. Excessive supply air temperature increases single family house's energy consumption even 320 kWh per degree. Supply air is usually heated with heat recovery system as much possible, and additional heat with electric resistors or liquid radiators connected to house heating system. In the picture below is principle of liquid-circulating supply air post-heating.

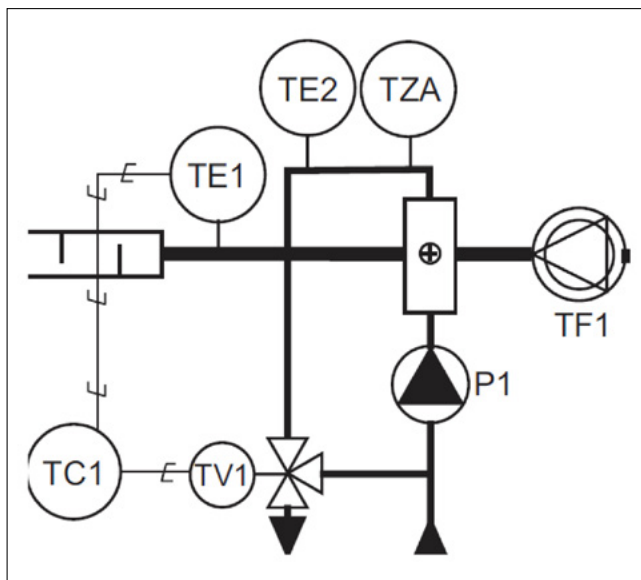

Picture 61.
Supply air heating

8 Pilot House Description in Levi, Finland

8.1 ABSTRACT

The Northern areas as in Scandinavia and Alaska offers excellent possibilities for low energy house testing in cold climate. Many component manufactures and other areas of industries research the performance and properties of their products in demanding conditions of Finnish Lapland. To offer better testing conditions and to increase know-how about component testing, Rovaniemi University of Applied Sciences has built a low energy house laboratory to the Arctic area of Levi. In the laboratory we will test so called “sandwich” – elements (concrete insulations), renewable energy systems for instance heat pumps and solar systems, building automation and air conditioning systems. We will be able to measure weather changes and what happens in the ground all the time. Measuring of the heat transfer helps to build energy efficient buildings in the future. The laboratory offers facilities to do worldwide cooperation with companies and other institutes in the future.

8.2 DESCRIPTION OF LOW ENERGY HOUSE

A low energy house used to be defined as a house which energy consumption is at a level below that is demanded in current building standards. The idea for sustainable homes and building regulations are now demanding much more stringent standards of energy efficiency for all new-built houses, making them all low energy houses.

The insulation factor is the most important of all energy conservation measures because it has the greatest impact on energy consumption. In an average new house, a well designed and installed insulation can reduce the amount of heat lost through the building structures by at least the half.

A low energy house has to take the advantage of low energy technologies in order to reduce the need of traditional technologies which can be inefficient and use large quantities of fossil fuel energy. There is often a need to store and distribute the heat in time and space of the low energy house. The air ventilation system is important for comfortable living environment, but it can also be possible to distribute heat in an efficient way in a house. To provide a comfortable low energy house there has to be a common control system handling both multi- source heating, and ventilation in efficient way, with smart sensors that can supervise the control process and automatically adjust all control parameters.

THE PROJECT IN LEVI

The project described in this paper is a joint interregional industrial development project between low energy house manufacturers, heating system suppliers, energy and ventilation systems manufacture, industrial development partners and universities in the North of Finland.

In the north of Finland there are few small house manufactures. The tendency today is strongly towards low energy houses, both because of the demands in the market related to rising energy prices and taxes, and because of the new EU legislation.

In most cases several different systems are used simultaneously. The combinations consist typically of fire wood or pellets, electricity, and various types of heat pumps. Today their control is typically based on pre-settings without any optimization, or connecting them to the control of ventilation systems.

There is thus a lack of intelligent and active control system for the complex system consisting of multisource heating, ventilation and other energy systems for low energy houses. The number of factors is high and there is no common specification. There is a need to optimize control algorithms and interaction between both heat and ventilation system. This is very important to gain the efficiency of low energy houses.

To get momentum and develop new control systems for low energy houses there is a need to summarize the demand of the low energy house manufactures in the region and create common functional and technical specification. From the users' perspective, there is a need to make the control and use of the systems so easy that they can be used effectively.

By creating the base for further development, the regional companies will get advantage with the means of rising technology and business cooperation between house manufacturers and product suppliers for control, heat and ventilation systems. New applications to control ventilation and heat system of a low energy house will create an opportunity to enlarge the market.

Initiative to the project came from the low energy house manufactures in the region, which has seen a steady and rapid development of the growing interest in the market for low energy houses. Today, the number of manufacturers able to deliver certified low energy houses is limited. These companies, that are in the forefront have good potential to develop better houses than other house manufacturers. However, more of existing companies will try to come into this market, and additional companies will be established.

The Arctic Low Energy Centre in Levi offers excellent potential to testing materials, technologies and equipment in the cold climate.

There will be six work packages (WP) in the low energy house in Levi.

Figure 1 shows the low energy house in Levi. The area is about 600 m², solar systems will be on the roof, and windows will be present day's windows and R&D test windows. Façade of the house is made of wood panels and the roof is made of tin.

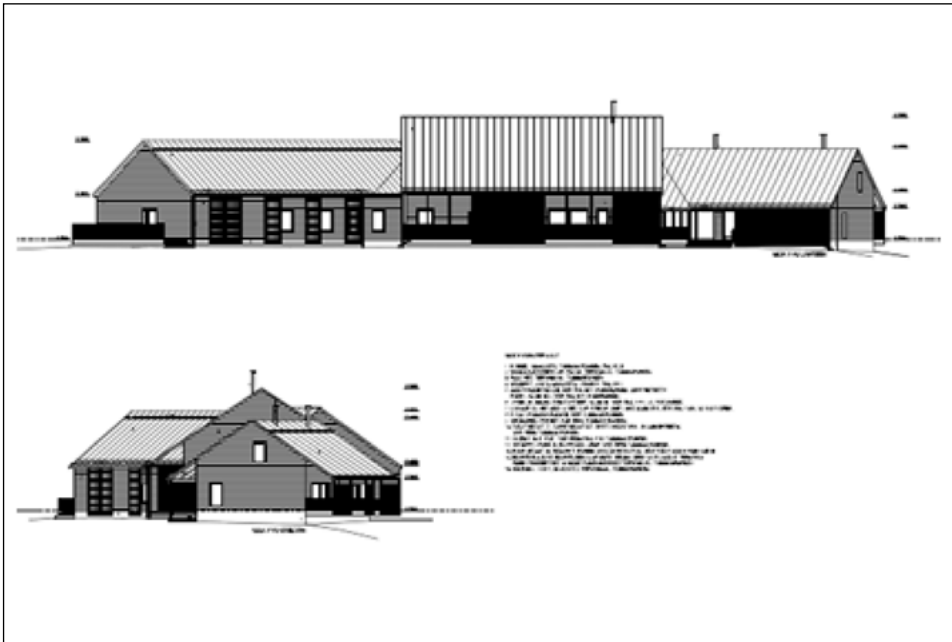

Picture 62. The low energy house in Levi

8.3 WORK PACKAGES

WP 1 - CONCRETE ELEMENT AND INSULATIONS

In this work package we research and development insulations in concrete elements in the cold climate. In WP 1 R&D the following insulators:

- stone wool insulation
- polyurethane insulation
- PLATINA insulation

The dew point is the temperature at which water vapor transforms into liquid water. This is a function of both temperatures and the amount of moisture in the air.

PANEL SOLUTIONS IN CONCRETE SANDWICH WALL:

- S1 (370 mm): 150 mm CONCRETE + 220 mm CORTEX-insulation (building plinth - CONCRETE). Figure 2 is the elements of concrete (S11 and S12). Elements S11 and S12 use CORTEX- insulation.
- S2 (430 mm): 120 mm CONCRETE + 220 mm preCast- insulation + 90 mm CONCRETE.
- Figure 2 is the elements of concrete (S21 and S22) use preCast-insulation.

- S₃ (390 mm): 120 mm CONCRETE + 180 mm ThermisolPlatina-insulation + 90 mm CONCRETE. Figure 2 is the elements of concrete (S₃₁ and S₃₂) use ThermisolPlatina-insulation.
- S₄ (405 mm): 150 mm CONCRETE + 250 mm “wool of lamel” Paroc FAL1c + PLASTER~5 mm (building plinth-CONCRETE). Figure 2 is the elements of concrete (S₄₁ and S₄₂ use wool of lamel; Paroc FAL1c + PLASTER.
- S₅ (350 mm): 120 mm CONCRETE + 140 mm SPU-insulation + 90 mm CONCRETE.
- Figure 2 is the elements of concrete S₅₁ and S₅₂ use SPU - insulation.

Elements S₁₁ and S₄₁ are installed in the north direction, the elements S₂₁, S₃₁ and S₅₁ in the east, elements S₁₂ and S₄₂ the south and S₂₂, S₃₂ and S₅₂ in the west. Elements of the U-value of 0.17 W/m²K.

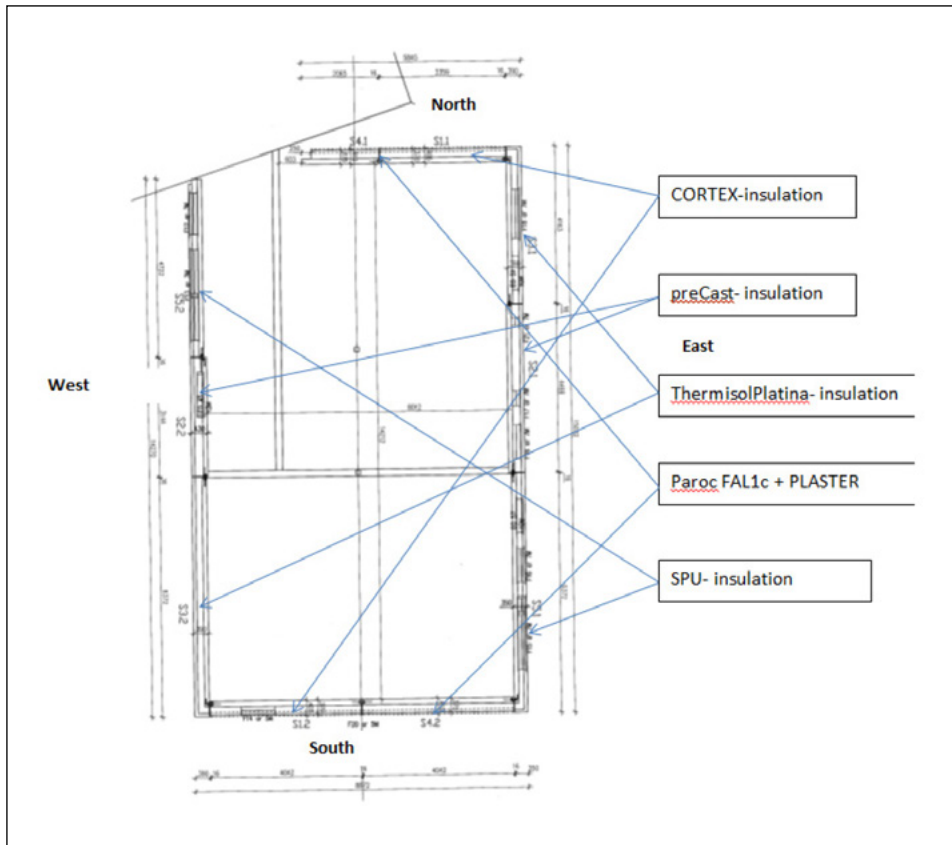

Picture 63. Panel solutions in the concrete sandwich wall

Inside the wall temperature and humidity are measured. Solutions to the problems that happen inside the wall near the dew point are researched, what is the best insulation of wall etc.

In the practical tests new information about how the heat transfers inside the wall in cold climate will get. Figure 3 shows the measurements systems in the wall. There are four measuring points in the wall and building plinth in landscape.

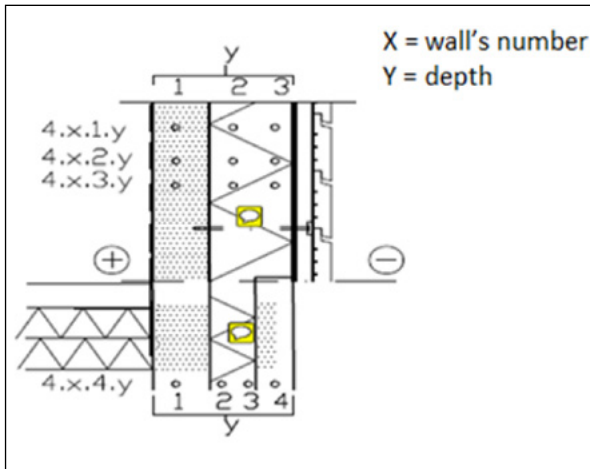

Picture 64. Measurements systems in the wall

WP 2 – GROUND HEAT PUMPS

When people build a small house they generally spend a lot of time in choosing the heating system. What's most important, however, is first to think whether the energy needs of the house can be reduced by better insulation and sealing.

The price of energy in its different forms will in all likelihood increase during the life span of the building. Investments that aim at reducing the building's heating requirements will always be more worthwhile in shortening the time in which they pay back.

Energy will be produced by using renewable energy for example ground heat pump. The COP value of heat pumps in cold climate will be tested in the Levi test house. The testing period will be two years and after that another model will be tested.

The COP was created to compare heat pump systems according to their energy efficiency. A higher value implies a higher (better) efficiency between the pump's consumption of energy and its output. While the COP is partly a measure of the efficiency of a heat pump, it is also a measure of the conditions under which it is operating: the COP of a given heat pump will rise as the input temperature increases or the output temperature decreases because it is linked to a warm temperature distribution system.

The COP of the ground heat pumps in cold climate will be tested.

We strongly believe that in the future the heat pumps are used more frequently in the energy technology, and finding the optimal design points for a heat pump or a cooling system is essential for the further development of these systems.

There is a heat pumps test laboratory in Rovaniemi University of Applied Science. The measurement systems use EN 14511 standard by testing heat pumps in laboratory. Before and after test in Levi we will test pumps in our test laboratory in Rovaniemi. Figure 4 is heat pumps test laboratory in Rovaniemi.



Picture 65. Test laboratory in Rovaniemi

WP 3 – SOLAR ENERGY

Solar collectors are flat plates and they are used for heating water for residential and commercial use. Solar collectors concentrate sunlight and are generally used for electric power production. The project wants to test the solar energy production and use in cold climate. It will compare heat-pipes and flat plates in Levi's testing house. In WP 3 reach and development solar systems both heating and electricity systems. In electricity systems will use inverters to conversion direct current to alternating current.

Figure 5 is the heat pipes on roof.



Picture 66. The heat pipes on roof.

WP 4 – AIR VENTILATION

The most usual way to control heating and ventilation in low energy houses is to control them separately. When there are several heat sources, also they are controlled separately by using pre-settings. The control algorithms are usually based on proportional control even though heat transfer is a very complex process involving e.g. delays because of the masses. When ventilation is concerned, the most usual way is to set the flow manually. The flow is constant even if in some room or in a whole house there is no one present, and the need is smaller. Ventilation losses vary typically from 10 to 15 % of the energy consumption. Air ventilation will be very energy efficiency in Levi's low energy house.

WP 5 – BUILDING AUTOMATION

Building automation describes the advanced functionality provided by the control system of a building. A building automation system is an example of a distributed control system. The control system is a computerized, intelligent network of electronic devices designed to monitor and control the electronics, and lighting systems in a building.

Building automation system's core functionality keeps the building climate within a specified range, provides lighting based on an occupancy schedule, and monitors system performance and device failures and provides email and/or text notifications to building engineering/maintenance staff. The building automation system's functionality reduces building energy and maintenance costs when compared to a non-controlled building. A building controlled by automation is often referred to as an intelligent building system or a Smart home.

Today there is a lack of intelligent and active control system for controlling the complex system consisting of multisource heating, ventilation and other energy consumption for low energy houses. There is a need to optimize control algorithms and interaction between both heat and ventilation system. This is very important to gain efficiency from low energy houses.

There are many sensors inside and outside the building. Sensors send data all the time to the data logger. The experts analyze the data by using the LabView program.

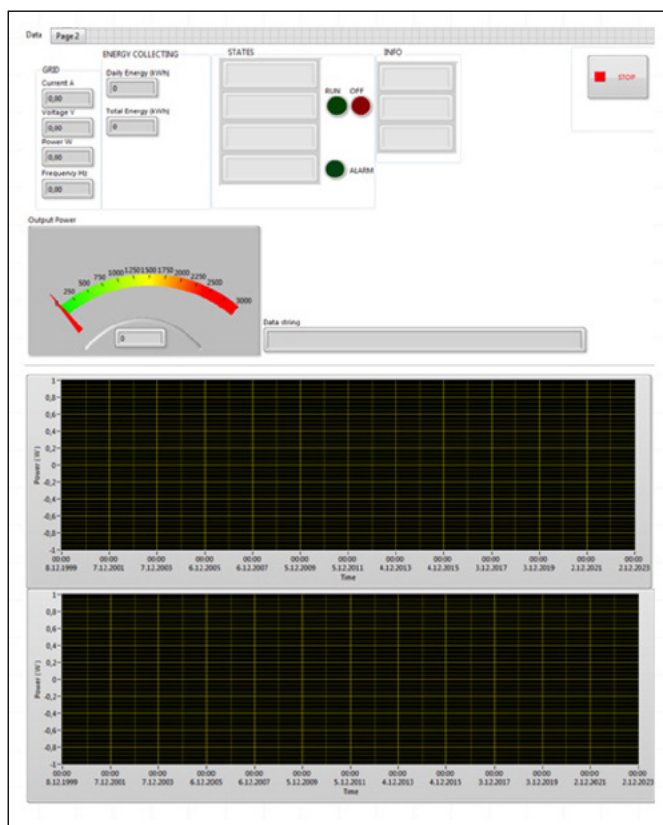

Picture 67. The monitor of LabView programmer.

WP 6 – WINDOWS

In Lapland multiple-glazing windows with at least two or three panes are of common practice. Typically, the replacement air for the extracted air in especially low-cost accommodation with forced extraction enters the interior space as leakage flow through window jambs and walls or through the supply air vents. The temperature for the air entering the room is close to outdoor air, which may cause the feeling of draft. Moreover, the whole supply airflow must be heated up to the indoor temperature by the heating system.

For instance in a supply air window, outdoor air enters the window cavity through holes or vents at the under edge of the window frame. The air flows upwards in the cavity while being heated by convective heat transfer from the surrounding panes. The heated air is then drawn into the room through a vent or an adjustable air valve in the upper edge of the window frame. When compared to the conventional case, the following results can be identified: 1) the supply airflow is pre-heated, which reduces the feeling of draft. 2) Less heating is required from the heating system to maintain the indoor temperature, which reduces the energy consumption. Furthermore, the size for the radiators can be reduced. 3) Heat losses through the windows are reduced since the surface temperature of the outer pane is lowered. This contributes to saving energy as well.



Picture 68. The supply air window in test laboratory in Rovaniemi.

8.4 SUMMARY

The purpose of the Levi project is to provide a proved concept of improving the energy, heating and ventilation efficiency of low-energy- and passive energy houses by developing automation in order to increase competitive advantage of the companies by fulfilling future customer needs and developing new standards and legislation. The research and development will be made with the help of house manufacturers, automation companies and housing service providers from both Finland and in cooperation with other countries. The research will provide a solid and credible concept that can easily show the end users how different technical solutions in the house manufacturing will affect the total energy consumption of the end product.

Cooperation with other companies in Europe will be very important to the low energy house in Levi, Finnish Lapland.

9 Unification of Home Automation and Building Technology

9.1 WHAT IS THE CHALLENGE AND WHAT IS AVAILABLE

/56/ /57/ The EU is targeting for a 20 % cut in Europe's annual primary energy consumption by 2020. The Commission has proposed several measures to increase efficiency at different stages of energy chain. The measures focus on the public transport and building sectors, where is greatest potential for energy savings. Heating of buildings is one of the biggest energy user on building sector in Northern Europe. In Finland residential houses space heating accounts for even 50 % of energy usage, hot water heating accounts about 20 % and rest goes to household electric, from where HVAC-control (heating, ventilation and air conditioning) accounts over 20 %. HVAC-systems play a major role in home automation and that connection is becoming much more important as savings takes center place.

9.2 WHAT IS AVAILABLE

The main idea of the present home automation systems seems to be different kind of state controls. For instance, Ouman Plus –home automation system's functioning is based on 5 different situation mode: HOME, OUT, NIGHT, LONG PERIOD OUT and COMING HOME. These modes are controlled by a key fob or remote control (web page, smart phone). Modes affect the functions of the house, for instance when out mode is set burglar alarm is activated, selected light- and electric units are turned off, heating and ventilation level gets lower, the main water valve shuts down etc. Most of the other home automation systems are based on various versions of state controlling. Nowadays when it's common to exploit energy from even several sources, it is expected that home automation systems can reasonably control their operations in most efficient way. Equipment manufacturers have at least taken this into account, for instance well-equipped water chargers include additional connections for heating systems etc.

9.3 COMPATIBILITY CHALLENGE

/58/ /59/ /60/ The intelligence of the home automation depends almost entirely from the systems programming and features of the used devices. When connecting different systems into the same automation system has interfaces of the systems be connectable

with each other. In the thiesis of Jarkko Jokelainen made for Ouman Ltd is studied, that even though the Ouman Plus automation system and the ventilation unit had same Modbus –protocol, they didn't operate like they should have. Manufacturer of the ventilation unit was going to proceed developing the units interface. Problems with the logic and controlling the system sensibly can occur when for instance several energy sources are connected to house automation system.

10 Sources

- /1/ http://www.ouman.fi/en/ouman_plus_ha_uk/ (23.10.2012)
- /2/ http://www.ouman.fi/fi/ouman_ouflex/ (23.10.2012)
- /3/ <http://www.ouman.fi/fi/flex-laajennusyksikot/> (23.10.2012)
- /4/ http://www.ebts.fi/documents/EBTS_100_webres.pdf (24.10.2012)
- /5/ http://www.fidelix.fi/documents/Fidelix_brochure_2011.pdf (24.10.2012)
- /6/ <http://www.smarthouse.fi> (29.10.2012)
- /7/ <http://www.talomat.fi/fi/kuluttajille/talomat-jarjestelma> (30.10.2012)
- /8/ <http://ecatalogue.schneider-electric.fi/GroupList.aspx?navid=79257&navoption=1> (12.11.2012)
- /9/ <https://customer.honeywell.com/en-US/Pages/Department.aspx?cat=HonECC%20Catalog&category=Programmable+Zone+Controllers&catpath=1.3.6.6> (13.11.2012)
- /10/ <http://www.deltacontrols.com/solutions-products/products> (13.11.2012)
- /11/ <http://www.beckhoff.com/> (13.11.2012)
- /12/ <http://eurlex.europa.eu/LexUriServ/LexUriServ.do?uri=CELEX:52010DCo639:EN:HTML:NOT> (16.11.2012)
- /13/ <http://www.europeancclimate.org/en/news/93-eu-qnearly-zero-energy-buildingq-targets-announced-for-2020> (16.11.2012)
- /14/ <http://www.rehva.eu/en/374.how-to-define-nearly-net-zero-energy-buildings-nzeb> (19.11.2012)
- /15/ <http://ieeexplore.ieee.org/stamp/stamp.jsp?tp=&arnumber=6059104> (20.11.2012)
- /16/ <http://ieeexplore.ieee.org/stamp/stamp.jsp?tp=&arnumber=6242577> (22.11.2012)
- /17/ <http://ieeexplore.ieee.org/stamp/stamp.jsp?tp=&arnumber=6287624> (26.11.2012)
- /18/ <http://ieeexplore.ieee.org/stamp/stamp.jsp?tp=&arnumber=6221443> (28.11.2012)
- /19/ <http://ieeexplore.ieee.org/stamp/stamp.jsp?arnumber=06168348> (29.11.2012)
- /20/ <http://www.buildingtechnologies.siemens.com/bt/global/en/buildingautomation-hvac/home-automation-system-synco-living/pages/synco-living.aspx>(18.12.2012)
- /21/ <http://www.ouman.fi/fi/eh-60/> (27.12.2012)
- /22/ <http://www.vantalvi.fi/index.php?id=4> (18.1.2013)

- /23/ European Technology Platform on Renewable Heating and Cooling; Common Vision for the Renewable Heating & Cooling sector in Europe (15.1.2013)
- /24/ http://era17.fi/wp-content/uploads/2010/10/sitran_selvityksia_39.pdf (1.2.2013)
- /25/ http://www.penantieto-opus.fi/files/Talotekniikan_automaatio_oppikirja.pdf (5.2.2013)
- /26/ <http://www.ouman.fi> (5.2.2013)
- /27/ http://www.ouman.fi/files/esitteet_englanti/ouman_eh-800_v.4_uk_low.pdf (8.2.2013)
- /28/ http://www.motiva.fi/rakentaminen/lammitysjarjestelman_valinta/lammonjaon_vaihtoehdot/vesikeskuslammitys (6.2.2013)
- /29/ www.nereus.fi (27.1.2013)
- /30/ http://www.motiva.fi/rakentaminen/lammitysjarjestelman_valinta/lammonjaon_vaihtoehdot (11.2.2013)
- /31/ www.energiatehokaskoti.fi (6.1.2013)
- /32/ http://www.euroheat.org/Files/Filer/documents/District%20Heating/Cooling_Brochure.PDF (3.1.2013)
- /33/ <http://www.euroheat.org/Default.aspx?ID=4> (3.1.2013)
- /34/ <http://energia.fi/tilastot/kaukolammon-hinnat-tyyppitaloissa-eri-paikkakunnilla> (3.1.2013)
- /35/ <http://www.energysavingtrust.org.uk/Generating-energy/Choosing-a-renewable-technology/Ground-source-heat-pumps> (4.1.2013)
- /36/ www.sulpu.fi (1.2013)
- /37/ <http://www.centralheating.co.nz/content/heat-sources/DeLonghiHotWaterHeatPumps.aspx> (4.1.2013)
- /38/ <http://www.nibe.eu/Domestic-heatingcooling/Airwater-heat-pumps/Function/> (4.1.2013)
- /39/ <http://www.ecobuild.co.uk/var/uploads/exhibitor/210/96d2cmxu4x.pdf> (4.1.2013)
- /40/ www.vesitakka.fi (3.1.2013)
- /41/ www.tekniikkatalous.fi (3.1.2013)
- /42/ www.savumax.fi (5.1.2013)
- /43/ http://www.motiva.fi/files/1375/Lampoa_puusta_puhtaasti_ja_uusiutuvasti_-_pellettilammitys.pdf (8.1.2013)
- /44/ <http://www.pellergy.com/wood-pellet-heating-systems/> (8.1.2013)
- /45/ http://www.motiva.fi/rakentaminen/lammitysjarjestelman_valinta/eri_lammitysmuodot/pellettilammitys (8.1.2013)
- /46/ <http://www.pellettienergia.fi/laskuri/index.html> (11.1.2013)
- /47/ http://www.kaukora.fi/en/electric_boilers (11.1.2013)
- /48/ http://www.kaukora.fi/en/products/oil_and-bio-oil_heating (11.1.2013)
- /49/ http://www.kaukora.fi/en/solar_heating (8.1.2013)
- /50/ http://www.motiva.fi/toimialueet/uusiutuva_energia/aurinkoenergia/aurinkolampo/aurinkokeraimet (11.1.2013)

- /51/ <http://www.energysavingtrust.org.uk/Generating-energy/Choosing-a-renewable-technology/Solar-panels-PV> (11.1.2013)
- /52/ http://www.motiva.fi/rakentaminen/lammitysjarjestelman_valinta /
tukilammitysjarjestelmat (11.1.2013)
- /53/ http://www.penantieta-opus.fi/files/vesi_ja_veden_kaytto_kiinteistoissa.pdf
(28.1.2013)
- /54/ <http://www.flaktwoods.com/productsservices/buildings/applications/housingresidential/single-family-houses/balanced-ventilation/> (8.1.2013)
- /55/ <http://www.haminanenergia.fi/fi/energiansaasto/lammitysjailmastoint/>
(14.2.2013)
- /56/ http://ec.europa.eu/energy/efficiency/index_en.htm (9.1.2013)
- /57/ http://www.msosy.fi/energiatietoa/energiansaasto/fi_FI/kodin-energiakulutus/
(9.1.2013)
- /58/ www.asennustuotteet.fi/index.pl?id=54&lang=FIN1 (12.12.2012)
- /59/ <http://www.iecon.fi/knx-eib-taloautomaatio/> (12.12.2012)
- /60/ <https://publications.theseus.fi/handle/10024/25630> (12.12.2012)
- /61/ http://www.naturalvent.co.uk/heat_recovery.asp (8.2.2013)
- /62/ <http://www.flaktwoods.fi/87adada6-568b-4484-ab84-a439762303d4> (13.2.2013)
- /63/ http://www.kaukora.fi/en/heat_pump_heating/inverter_air_heat_pumps
(11.1.2013)
- /64/ Fraden J. 2004. Handbook of Modern Sensors. Springer. Third Edition.
- /65/ www.Betatherm.com. /Betatherm.aspx. 2011 Datasheet, Series 1 Bare leaded
Termistor.
- /66/ www.hygrosens.com . 2012. Datasheet, SHSA4.pdf.
- /67/ <http://www.farnell.com/datasheets/1599740.pdf>
- /68/ <http://www.delphian.com/electrochemical%20sensors.htm>
- /69/ <http://www.apollo-sensors.com/so4/apollo-sensors/cpxx/20090630/7273289.html>
- /70/ <http://www.senseair.se>
- /71/ <http://www.edinburghsensors.com/Technology/dispersive-vs-non-dispersive-ir-sensors/>

Automation systems are used in most buildings nowadays. In the past they were mainly used in industry to control and monitor critical systems. During the past few decades the automation systems have become more common and are used today from big industrial solutions to homes of private customers. With the growing need for ecologic and cost-efficient management systems, home and building automation systems are becoming a standard way of controlling lighting, ventilation, heating etc.

Automation of houses and other buildings vary between countries even though some products are more widely used. There is a need to map the state-of-the-art of those available in the market, and to explore what type of research results has been published in the recent years to get an implication what type of products will be coming into the market in near future.

Other automation sectors – especially the industry automation – is highly developed. Thus benchmarking between building and industrial automation is needed regarding both the existing systems and standardization even though there are specialized buses for building sector.

There is also a need to explore current state of building technology. Are there possibilities to develop cooperation between automation providers and building technology manufacturers. Is building technology progress for single family houses on the same level than automation system progress.



**INTERREG
IV A/NORD**



**REGIONAL COUNCIL
OF LAPLAND**



**Länsstyrelsen
Norrbotten**

LAPIN AMK⁷

Lapland University of Applied Sciences

www.lapinamk.fi

ISBN 978-952-316-026-2