



**TAMPERE POLYTECHNIC**

**BUSINESS SCHOOL**

**FINAL THESIS REPORT**

**Analysis of packing method improvements for Metso Minerals  
(Tampere) Oy**

**Maarit Hakala**

Degree Programme in International Business  
April 2008  
Supervisor: Anasse Bouhlal

**TAMPERE 2008**



**Author(s):** Maarit Hakala

**Degree Programme(s):** BBA - International Business

**Title:** Analysis of packing method improvements for Metso Minerals (Tampere) Oy

**Month and year:** 04/2008

**Supervisor:** Anasse Bouhlal

**Pages:** 125

---

### **ABSTRACT**

Metso Minerals is a global corporation that has numerous shipping locations all over the world. Metso Minerals is also constantly acquiring new customers while paying special attention to customer retention. According to a study by a marketing research over 40% of all customers in today's market economy take their business elsewhere/change over to a competitor due simply to a lack of contact.

Every day hundreds of packages are shipped and received from numerous different manufacturers, Metso Minerals' warehouses and customers. No unified packing instructions exist.

It is the purpose of this thesis to analyse and compare the current methods of packing and introduce some new ideas of improvement for the future.

Additionally, if a form of consistency is globally assumed in packing critical, sensitive and fragile parts, the cost in damages and shipping processes will reduce, damages will be minimized and the quality and customer satisfaction will improve. This work will also make it easier to compile a shipping manual to be used globally. In addition, the Logistics European Project (LEP). (LEP – Logistics European Project will be examined in the latter part of the thesis.)

I sincerely believe that this thesis will help, not only the global logistics offices, but also be a valuable resource to the grassroot level, among the actual people who do the most valuable work of all; packing the critical parts for Metso Minerals.

The drive and motto while writing this thesis has been; to develop, to demonstrate and to apply.

At this point I would like to acknowledge and give my heartfelt thanks to my instructor Anasse Bouhlal, who took the time out of his tremendously busy schedule to always be there to help me, and my school Tampere University of Applied Sciences.

My special and undying gratitude goes to the "Logistics Guru" of MM; Heikki Kivijärvi, without whose help and mentoring the improvement ideas would have stayed in the dark. I also wish to thank Metso Minerals in Sorocaba, Brazil and Metso Minerals in Macon, France. Their incredibly professional and talented teams provided me with extraordinary knowledge and support.

I would also like to extend my sincere appreciation and thanks to Metso Minerals (Tampere) Oy for making this work possible.

This work would not have come to be without my fiancée who has helped me through hard times and has given me his undivided attention and support when ever I was in need of mental, financial or technical help. I thank him for that.

---

**Keywords:** Packing Packaging Shipping Logistics Critical parts

# Table of Content

<b>1. Metso OYJ</b>	<b>1</b>
1.1 Metso conglomerate	1
1.2 Metso's customers	2
1.3 Metso's business idea	2
1.4 Metso's purpose	3
1.5 Metso's values	3
1.6 Metso's strategic goals	3
1.6.1 Customer satisfaction	3
1.6.2 Operational excellence	4
1.7 Metso's ethics	4
1.8 Metso's global position	5
1.8.1 Metso's net sales according to market areas	6
1.8.2 Metso's net sales according to Metso's business areas	6
<b>2. Metso Minerals</b>	<b>7</b>
2.1 DC – sales of wear- and spare parts	8
<b>3. Shipping instructions manual</b>	<b>8</b>
3.1 Background	9
3.2 Object	10
3.3 Purpose	10
3.4 Packing currently	10
3.5 Quality and ISO 9001 (year 2001) in Metso Minerals	11
3.6 Metso Minerals' material flow	11
<b>4. Parts examined</b>	<b>12</b>
4.1 Packing and shipping axles	13
4.2 Packing and shipping batteries	14
4.3 Packing and shipping electronic parts	15
4.4 Packing and shipping bronze bushings and bearings	16
4.4.1 Packing & shipping bronze parts in separate boxes	16
4.4.2 Packing & shipping bronze bushings and bearings using pallet frames or in a singular parcel	18
4.4.3 Shipping multiple bushings in a single box	20
4.5 Storing bronze bushings and bearings	23
4.6 Packing a multi-shipment (including a spacer ring)	25
4.7 Packing and shipping a torch ring	26

4.8 Shipping dangerous goods and hazardous materials	27
4.9 Packing and shipping a drive pulley	27
4.10 A simple way to pack and ship a dust seal	29
4.11 Packing and shipping a hammer bolt & any long parts	29
4.12 Packing a fastening item	30
4.13 How to pack and ship a lifting ring safely	31
4.14 Wrapping multiple parcels in one shipment boxes (Macon, France)	32
4.15 Shipping protection plates	33
4.16 Packing and shipping rollers and gliders	33
4.17 Packing and shipping parts with screwed ends	34
<b>5. Manganese</b>	<b>37</b>
5.1 Crushers and Jaws made of manganese	38
5.2 Storing manganese	41
5.3 Shipping manganese	45
<b>6. Damages due to packing</b>	<b>48</b>
6.1 Examples of common mistakes when packing	49
6.1.1 Some of the main problems in packing	49
6.2 Direct feedback from Tampere Metso Minerals' warehouse	50
6.2.1 Special boxes	50
6.2.2 Painting vs. nature	50
6.2.3 Problems with Russia	51
6.3 Heavy items on top	51
6.4 Rusted main shaft	52
6.5 Damaged roller assemblies	55
6.6 Using metal cord straps	56
6.7 Severely damaged main shaft	57
6.8 Damaged plates on a pallet	58
<b>7. Improvement ideas on packaging, shipping and quality assurance implemented in ERP</b>	<b>58</b>
7.1 An improvement idea for shipping a main frame	59
7.2 An improvement idea for shipping a drive ring	61
7.3 An improved idea for shipping a mantle	61
<b>8. Implementing packing information into the ERP system</b>	<b>63</b>
8.1 Improvement ideas for lashing manganese using cord straps	64

<b>9. Improvement ideas for all critical parts</b>	<b>66</b>
9.1 Shipping concerns in Brazil	67
9.1.1 Condition of arriving parts	67
9.1.2 Matters of deliveries	67
9.1.3 Matters of specific parts	67
9.2 Improvement ideas for Macon, France	67
9.3 Improvement ideas combined from MM and Valmet	68
9.4 Planning a standard package	70
9.4.1 Stackability	70
9.5 General instructions on packing improvement	72
<b>10. An idea to standardize</b>	<b>73</b>
10.1 Idea I	73
10.1.1 Current directives on materials handling according to DC Tampere	75
10.1.2 Current shipping instructions for suppliers and subcontractors, DC Tampere	76
10.2 Idea II	77
10.2.1 Example of a possible outlook of a page in the manual	79
10.3 Positives of standardization	81
10.4 Possible problems with standardization	83
<b>11. The shipping manual</b>	<b>83</b>
11.1 An alternative improvement method investigated	85
<b>12. Outsourcing the packing process</b>	<b>86</b>
12.1 How does outsourcing work?	87
12.1.1 Questions that must be asked when outsourcing	87
12.1.2 Sandivk's strategic partnering idea	88
<b>13. LEP – Logistics European Project</b>	<b>89</b>
13.1 Trends and dynamics in SCM	89
13.2 Transportation concept for LEP	90
3.2.1 The current situation in transportation	90
13.2.2 The objective for future transportation in LEP	90
13.2.3 The future structure for transportation for LEP	91
13.2.4 The road transportation after implementing LEP	92
13.2.5 Stock replenishment and wear parts for the LEP	92
13.2.6 Emergencies and breakdowns (ground transportation) during LEP	93
13.2.7 Air and ocean transportation for the LEP plan	93

13.2.8	Emergencies and breakdowns (air transportation for LEP)	94
13.2.9	Courier transportation plans for LEP	94
13.3	Transportation partners for the LEP	95
13.4	Possible packing and shipping problems in LEP	95
13.5	Why a centralized warehouse? (LEP)	96
13.6	Key location factors for LC's - Logistic Centers in LEP	96
3.6.1	Why Belgium?	97
<b>14.</b>	<b>Packing materials</b>	<b>98</b>
14.1	Measurements of parcels	98
14.2	Alternative packing materials	99
14.2.1	Alternative packing materials used in Metso Minerals	99
14.2.2	Alternative packing materials for protecting the parts used in Metso Minerals	100
14.3	Storage space of packing materials in Metso Minerals	102
14.4	The use of pallet frames as the main packing materials in MM	103
14.5	Packing material alternatives from Finland	105
14.6	Plywood boxes and pallet frames	106
14.6.1	A plywood box	106
<b>15.</b>	<b>Pallets</b>	<b>107</b>
a.	Standard pallets	108
<b>16.</b>	<b>Labels</b>	<b>109</b>
16.1	Invoices	110
16.1.1	Variations of invoices	111
<b>17.</b>	<b>Future legal issues</b>	<b>112</b>
<b>18.</b>	<b>Costs</b>	<b>114</b>
18.1	An example of cost of manufacturing and repairing a pallet	115
18.1.1	Manufacturing	115
18.1.2	Repair	116
18.1.3	Costs for the quality inspections	116
18.1.4	Other services	126
<b>Summary</b>		<b>118</b>
<b>Future Possibilities</b>		
<b>Abbreviations/Terminology</b>		<b>120</b>



(Pic.1) *Metso logo*

## **Analysis of packing method improvements for Metso Minerals (Tampere) Oy**

### **1 METSO OYJ**

#### **1.1 Metso conglomerate**

Metso is a global engineering and technology corporation. In early 2008 Metso's shares will split and dividends are doubled from €1, 50 to €3, 00, turnover increased 23% from 2007. Metso's business profit was reported as €180 million. Turnover was €1896 million which exceeded the analysts' forecasts by nearly €10 million. Order log was €4,3million and bases a solid growth ground for the year 2008. Operating profit for 2006 was calculated at €457,2million. Metso has 22 thousand employees all over the world in over 50 countries. Metso is a world wide deliverer of systems and machines and expert services for process industry. The company has concentrated its core processes to four key areas and is a global market leader in:

- pulp and paper technology (Metso Paper)
- rock and minerals processing (Metso Minerals)
- automation and adjustment technology (Metso Automation)
- fiberboard technology, machinery and special vehicles (Metso Ventures)

*Source: Taloussanommat 6.2.2008*

Metso's stocks are noted on the Helsinki (ME01V.HEX) and New York (MX.NYSE) Stock Exchanges, and it has more than 30 000 shareholders.

(Pic.2) *Lokotrack*



(Pic.3) *steel factory*



(Pic.4) *Metso Automation*



## 1.2 Metso's customers

Metso's growth does not seem to be slowing down. Metso's strong customer-driven industry concentrates on solid financial performance over the quarterly cycles and the end-product demand is constantly growing. Metso's main customers consist of capital intensive businesses. They look to a long term perspective in their business relationships and are "global players". Metso is also constantly looking to consolidations, mergers and acquisitions to maintain their growth momentum. One, if not the most important task for the Metso board of directors is their endeavor to continuously improve return on assets. Another future vision for Metso is to increase the focus on their core operations. Metso currently holds a significant share of the aftermarket.

Metso's customers have high expectations for the company to deliver for example high return on capital that is employed. They want productivity, usability and quality of their production processes. As well as giving the customers expect to receive a long term commitment in doing business with Metso. They expect Metso to take life cycle responsibility of its products and services. Metso must also have an extremely visible local presence. This is achieved through suppliers and dealer agents.

The customer for Metso Paper is mostly the paper, board and pulp industry. The customer base of Metso Minerals consists mostly of quarries, aggregates producers, construction and mining industries. Metso Automation services the pulp and paper industry but also energy, oil and gas industries. Metso Ventures also deals with construction and furniture industries. Metso Ventures also collaborates a lot with the other Metso's business units by supplying them with i.e. cast iron and steel components. This makes other Metso business units customers of Metso Ventures. Because Metso Ventures is such a variable business unit, its customers also include pulp and paper, mining, aggregate production, metal recycling, chemical, energy, oil and gas, metallurgy and general engineering industries. Since Valmet Automotive is a division of Metso Ventures it is quite obvious that the customer base includes car manufacturers.



### **1.3 Metso's business idea**

The purpose of Metso is being the best in Engineering Customer Success. This combines the technology know-how and the customers' success which are the main business ideas of Metso. The customers know to expect productivity, competitiveness and environmentally safe solutions from Metso through out the entire life cycle of a process.

### **1.4 Metso's purpose**

Metso's purpose is to achieve and maintain customer success because if the customer is happy the company is more likely to retain the existing customer and through word of mouth even receive new business associates. The customer's success is also directly related to the company's success. The customer receives products or services and the company receives compensation.

### **1.5 Metso's values**

The most important value for Metso is the customer's success. Profitable innovation is also a key to keep up in the fast moving area of technology and competition. Professional development is a factor that most importantly keeps an organization growing in the right direction. Research and development are merely a part of a company's development. Professional development means that the organization is required to maintain the professional excellence through constant development of employees and the company as a whole. Professional development is imperative to keep Metso current with the ever changing technology and practices through lifelong learning. Metso also wants all the employees to be personally committed to their work to achieve the best possible results.

### **1.6 Metso's strategic goals**

Metso's strategic goals towards their vision consist of two goals.

#### **1.6.1 Customer satisfaction.**

Customer satisfaction is enhanced by finding the best solutions to customer needs throughout the process life cycle. Customer satisfaction is also maintained through a comprehensive contact network domestically as well as internationally. Metso assumes a customer-oriented approach in all operations. A strong presence on local levels of the global market is a strategic point to have the Metso name become known as the market leader in all parts of the world. Strategically Metso needs to maintain leading technology in all of its business areas.

### **1.6.2 Operational excellence**

To enhance productivity Metso constantly aims to improve quality and production. Productivity is aimed to be improved through global business alliances, leadership position in the market and human resource processes so that Metso is seen as a desired employer and a business partner in the global markets. Metso is also continuously improving its management and people processes to continue to carry the brand of a world-class business. Another milestone closer to fulfilling the Metso vision is when profitability and company growth exceeds the growth of their peers and competitors.

Through these defined purposes, innovational values and strategic goals Metso can achieve their ultimate goal to become the industry benchmark. However, to get there Metso needs to motivate all the employees, including the management to do their best in their every day work while selling to new customers and retaining the existing ones.

Metso becoming the industry benchmark is very attainable since the competition is very few and the ones that do exist are small companies and do not possess the ability to compete with the giant.

### **1.7 Metso's ethics**

Metso's ethical principles are formulated to act as practical tools to the personnel and other interest groups. They combine the commonly agreed standards of activities that are founded on practical and global principles of company ethics and the principles of responsible actions. At the same time they support the business unanimity and lasting development of the entire corporation.

Metso is committed to act as a good business citizen all over the world. To achieve this goal supposes all Metso employees to follow these durable principles:

- Integrity
- Honesty
- Following laws and regulations
- Transparency and openness
- Respecting human rights

- Equality and fair and impartial treatment (non-discrimination)
- Intangible equity (i.e. intellectual property and education of the personnel)
- Rejection of corruption and bribes
- Health and safety
- Participation in community activities and sponsorships
- Environmental protection
- Ethical standards in relationships to suppliers

Source: [www.metso.com](http://www.metso.com)

## METSO'S STRUCTURE

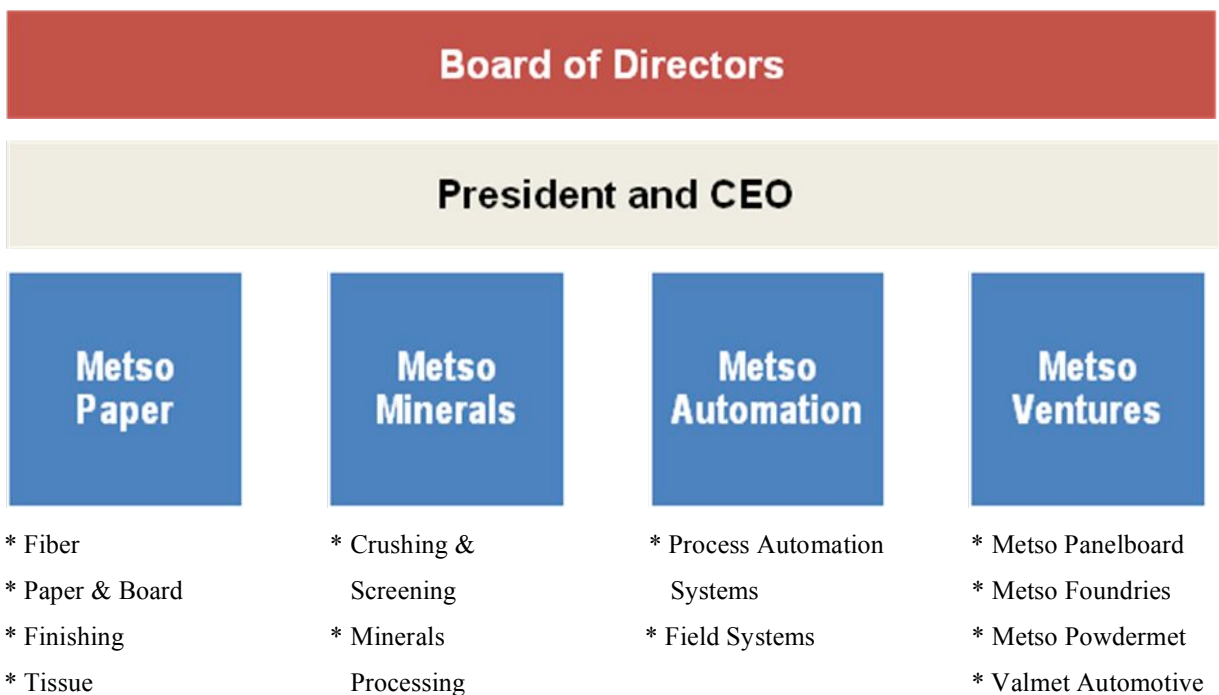

(Table.1) *Metso Structure*

### 1.8 Metso's Global Positions

Metso Paper is the global number one in pulp and papermaking equipment and processes.

Metso Minerals is the global number one in rock and minerals processing equipment and processes.

Metso Automation is the global number one in pulp and paper industry special analyzers, consistency transmitters and control and automated valves production. It is also a global number 3 in providing pulp and paper automation solutions.

Metso Ventures is in the global top three in Panelboard equipment manufacturing.

#### 1.8.1 Metso's Net Sales According to Market Areas

Metso's net sales are concentrated in specific market areas throughout the world. For example, in 2005 the net sales that originated from Finland were only approximately 8 – 9%. The largest net sales came from other European (25%) and Nordic (12%) countries. North American net sales were about 21% and the Asia-Pacific region followed with net sales of about 17 – 23%. Interestingly enough, even though most of the mining and excavation is done in South America, Brazil being one of the leading countries of manganese production, the net sales of South and Central America were left under 13%.

### **1.8.2 Metso's Net Sales According to Metso's Business Areas**

Metso Minerals provides approximately 40% of the total net sales of the Metso conglomerate, making the rock and minerals processing the most important business area of Metso. Metso Paper is a close second bringing in about 39%. Metso Automation's business area contributes circa 14 – 15% and Metso Ventures about 6 – 7% of the net sales.

Metso Paper and Metso Minerals are the two main business areas that employ most of the Metso's personnel. Together they provide work for about 80% of the total labor force. Only about one percent work in corporate offices and in shared services.

*Source: [www.metso.com](http://www.metso.com)*



(Pic.5) *Metso Minerals logo*

## **2 Metso Minerals**

Metso Minerals is a part of the Metso conglomerate. Metso Minerals develops plans and delivers complete solutions for drilling, crushing, grinding, enriching, screenings and shipping of rock and other minerals.

Metso Minerals is a global market leader of rock and minerals handling systems. The main products are crushers, screens, mining equipment, refiner engines, wear protections and conveyor belts. In addition to different fixed crushing plants Metso Minerals manufactures cylinder and roller mounted crushing and screening units for recycled crushing industry among others.

Metso Minerals is also a significant supplier of scrap-metal recycling equipment. The plants and units are massive acquisitions therefore Metso Minerals also carries a great role in the after care of the units. Automation applications, the condition inspections of the plants, modernizations, regular maintenance and especially wear and spare parts make an important part of Metso Minerals' operations.

The reason Metso Minerals uses its own sales companies, is that the sales of the products require certain expertise regarding the markets and the conditions existing in the particular country. It also requires the knowledge of the country's language so that the end customers can be serviced as well as possible. The sales companies are important because the entire service which runs 24 hours a day must be arranged according to customer needs. The sales companies have their own service providers who go around in the field to assist the customers in their technical problems and are crucial for example in breakdown situations when help and spare parts are needed immediately.

*(Source: [www.metsominerals.com](http://www.metsominerals.com))*

### **2.1 DC – sales of wear- and spare parts**

DC (Distribution Center) Tampere develops, acquires, stores and markets all the crushers wear and spare parts made in Tampere. DC Tampere has a global technology responsibility of the crusher products' wear and spare parts of Tampere, a global technology tied equity responsibility and a global technology based commercial responsibility. In addition the unit is responsible for the redesign of the unit parts for third parties and for the implementation of the after market strategy for the business in the entire supply chain.

DC Tampere is divided into several different teams. The team that is responsible for the purchasing, supplier collaboration, shipping details for incoming materials and controlling and developing is called warehouse control. Additionally the warehouse control team oversees the entire import process of Metso Minerals (Tampere) Oy. Materials management is responsible for the inspections and receiving of materials, inventorying, picking, packing and shipping. The customer support acts as the main contact for the sales companies. It is responsible for the orders and offers handling, maintaining orders and billing and the shipping arrangements for outbound materials. The product support acts as a technical support to the sales companies, takes care of pricing and price-lists, defines critical and strategic parts and warehouse recommendations and handles warranty and change fact sheets. The product support team also takes part in new product projects bringing in an after market view and develops the crushing processes from the wear parts point.

Global management is also based in Tampere office. It consists of Customer Service managers, and product managers. There are also several specialists that work in DC Tampere.

### **3 Shipping instructions manual**

The shipping instruction manual will help training of new and seasonal warehouse staff. All the shipping locations already have their own way of packing since no manual is being followed. By not having a unified, global solution (a manual) for the packing process of the critical parts, makes the current packing process time consuming, often clumsy and expensive. Instructions for packing is sorely needed especially when packing manganese, electronic parts, bronze and other parts made from soft metal. This thesis will concentrate directly on these specified parts. The thesis will function as a reference point to all employees involved in shipping, packing and parts identification. This work can be referred to along side a shipping manual (a form of a manual has since been produced by using the material gathered for this thesis) and will provide informative, yet simple examples with the help of numerous photographs and written text. The content focuses mainly on packing and handling of heavy,

expensive, fragile, electronic, soft and odd-shaped parts that may require special attention when packing and shipping through pictures and text.

Package labeling will also be discussed, including a correct way of attaching shipping- and address labels, waybills and bills of lading. Packing materials are covered briefly, using mostly demonstrative photographs of the materials themselves. Each example will contain suggestions and variations of materials needed to pack the part in question safely for the particular method of transportation used.

In-bound items to warehouses (parts that arrive to the warehouses from an outside supplier) are dealt with concisely to ascertain an optimum storage cycle and shelf life. The object is also to try to minimize the need to open each and every parcel that arrives to the warehouse. Optimum goal would be to achieve such a method of labeling and packing that once a package arrives to a warehouse, it can be controlled (for example scanned with a bar code or an RFID system) and held in storage as is until further shipment due to a customer request. This procedure will provide valuable benefits to the inventory control department as well as the end user and final customer.

This thesis is directed to act as an aid to the handbook prepared for the centralized warehouse location in Belgium. The manual will mainly be used by Metso warehouse personnel, suppliers, dealers, any external warehouse locations and sites as well as transportation service partners.

A standardized method of packing has been long over due in Metso Minerals and it will surely reduce damages, enhance customer satisfaction, reduce delivery time, optimizes the stowage percentage (fill rate) and reduce costs related to claims in damages due to insufficient packing

### **3.1 Background**

The background of the final thesis is based on Metso Minerals' need to improve the directions of packing of certain defined parts, in order to provide a global guideline. The thesis concentrates only on specified parts that require detailed attention when packing and shipping globally. Some of these parts are, for example, electronic parts, heavy items, bronze-, manganese- or fragile parts, i.e. parts that can be bent, scratched or otherwise injured and damaged during transportation.

### **3.2 Object**

The object of the thesis is to improve packing by making it more efficient through quicker packing time, reduce costs by preventing damages and shorten the packing (WIP) time and to standardize the packing process by providing global instructions that can be used in any Metso Minerals- or other centralized warehouse locations. This will also lead to fewer mistakes in packing. The object of this action directive is also to provide a compact procedure and information guideline to the departments handling material- and information-flows connected to the wear and spare part shipments globally.

### **3.3 Purpose**

The purpose of the material gathered is to map out how the packing is currently done in Metso Minerals, and to analyze how these methods can be improved. There are no unified instructions or directives on how to pack these parts currently. For this purpose, a manual for global shipping instructions, package identification and storage could be made using the material in this work. The manual would ease the training of existing, new and seasonal warehouse personnel by providing some general guidelines on packing, storage, package identification and contingency shipping before they start working in the warehouse. (i.e. seasonal staff) The manual should also be in such a form that they could be easily accessed by everyone working in a warehouse, in a dealer agency or other departments including sales departments and product design departments. The manual could be in either electronic form, in a form of a manual and eventually be incorporated into an upcoming ERP system be it SAP or other of a kind. The key is to make the new instructions available to everyone.

### **3.4 Packing Currently**

The packing procedure is currently done based on an individual's opinion on the best way to pack. There are no instructions or manual to assist in having a global method of packing. The quality of the package depends on the packing personnel's individual objectivity on how to achieve an acceptable way of packing. In order to get a comprehensive picture on the current way of packing throughout the world, material was gathered from three countries. The following work analyses the various methods used in packing today in Metso Minerals warehouses of Tampere/Finland, Macon/France and Sorocaba/Brazil. Some methods are demonstrated through pictures.



### 3.4 Quality and ISO 9001 (year 2001) in Metso Minerals

When all the units function according to a known required way, the result is easy to forecast. The desired result is improved by changing and developing the policies. This gives way to an enhanced quality. Quality is measured by auditing every process individually. The measurements are also documented. This is called the quality management system. It is enforced by both internally and externally. Matters monitored are sales and inventory classification, order transactions, breakdown orders and calculations of sales lines in the inventory -> ABC analysis. The most critical matter measured is the technical inventory production. Technical inventory production is monitored differently. It is the most critical matter measured.

Reclamations are monitored quarterly. The reclamations are mostly warranty issues, not quality related. Manganese issues are more difficult to document properly. Essential in the quality development process are the aberrations gathered from the operating sequence. This is the reason why information flow is imperative.

*Source: Quality training participation in 2006*

### 3.6 Metso Minerals' materials flow

The DC (distribution center) stores all critical parts and the LSU stores products that sell more than four times per year. The DC does not sell directly to customers. Global organization is directed by global policies.

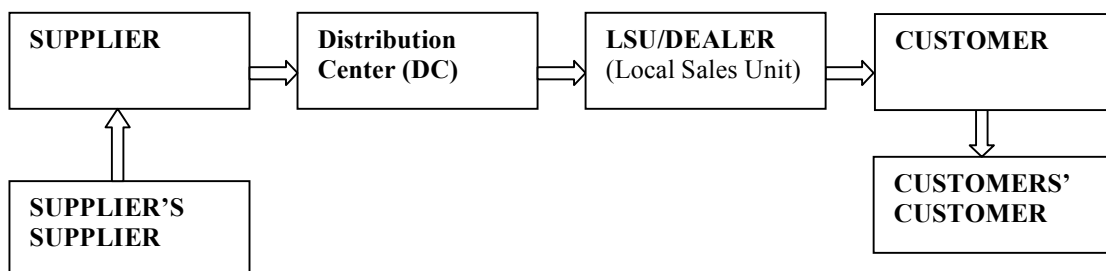

(Table 2) *Metso Minerals Supply Flow*

## 4 Parts examined

The parts included in this thesis consist of critical, fragile, heavy, expensive and hard to pack parts.

These parts include, but are not limited to bronze parts, manganese parts, batteries, shafts, electronic parts, axles, bushings, screws, rollers, protection plates, seals and batteries. Extreme consideration must be used to pack these parts in order to avoid unnecessary damages. The recommended packing materials have been observed to protect the parts during shipments. The parts, and how to ship them properly, that are examined in this work are:

- Axles
- Batteries
- Bronze parts
- Bushings
- Bearings
- Electronic parts
- A dangerous goods shipment
- Drive pulleys
- Seals (i.e. dust seals)
- Eye screws and other wedged and screwed parts
- Fastening items
- Hammer bolts
- Lifting rings
- Lifting tools
- Various Manganese parts including crusher jaws and mantles
- Protection plates
- Rollers and gliders

Additionally shipping labels and shipping materials will be examined, as well as storing parts, damages due to poor packing process, terminology, improvement ideas and costs from the saving point of view.

#### 4.1 Packing & Shipping Axles

Axles are heavy items and are usually shipped via sea freight. In most cases a specific stand is built to support the weight of the axle. The axle must be protected from the corrosive elements such as water, humidity and ice. The safety of the people handling the part is also imperative.

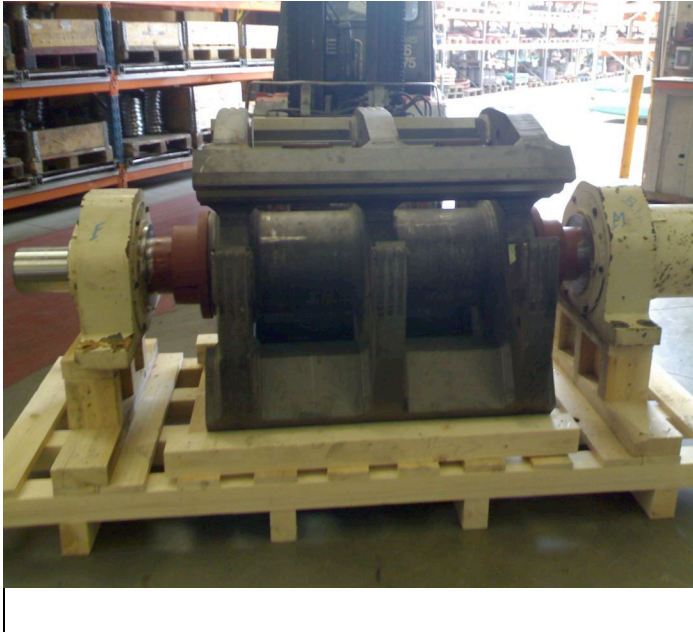

(Pic.6) here a special stand is built to hold the weight of the axle.

The axle is then protected with heavy shipping plastic, wrapped with plywood and several sets of heavy duty metal wraps. The plastic and plywood also enable the shipping labels to be attached more easily. It is still important to insert labels (stickers) onto the part itself. This way, in case the outside material is torn, the part itself still has the address information of the shipper and the consignee.



(Pic.7) an axle in plastic wrapping.

## 4.2 Packing & Shipping Batteries

When packing batteries it is best to pack them onto a pallet with pallet frames. IPPC (International Plant Protection Convention) stamped wood should be used to form “compartments” on the pallet so that the batteries can be fitted one in each compartment. After this, the parts need to be cushioned with any recyclable cushioning material. Here, a recyclable cushioning material called PadPack is used. This will prevent the parts from shifting during transportation.



(Pic.8) *two batteries in separate “compartments”.*



(Pic.9) *finally a lid is fastened on the top of the package, shipping plastic is wrapped around the parcel and metal wraps are tightened around the pallet and the package.*

### 4.3 Packing & Shipping Electronic Parts

Electronic parts are also considered critical items and special attention must be paid when shipping them. Here a frame is built to protect an electronic part leaving the part between the frame and the pallet. The part must also be wrapped in plastic to prevent moisture from getting in.



(Pic.10) *a wooden frame built to protect the part.*



(Pic.11) *plastic is wrapped over the part to keep moisture out.*

#### 4.4 Packing & Shipping bronze bushings and bearings

Bronze parts are extremely fragile to ship. This is due to the fact that they are such soft material that is easily subjected to scratches, dents and bending. The sockets, bushings and bearings must always be shipped on an upright position. Even a smallest nick makes the part completely un-usable. Therefore the shipping staff must take extreme care when packing these fragile and critical parts. The bushings and bearings also cost thousands of Euros so damages will be tremendously expensive.

##### 4.4.1 Packing & Shipping bronze parts in separate boxes

Bronze shafts and bushings are soft, heavy and expensive parts. It is important that extreme care is used when packing these parts. These two parts can be packed individually or together. In this case the parts are packed in two separate boxes.



(Pic.12) *a bronze shaft and a bushing.*

Anti-corrosive plastic is used to line each of the boxes. This (Zerust) plastic prevents corrosion in three different methods; A) It passes an electron-current from a high energy area of a metal to a low energy area. B) By forming a layer of molecules onto the surface of the metal it prevents water or moisture to get in contact with the metal itself. C) It regulates the PH-value of electrolytes. The plastic emits molecules that prevent moisture from gathering inside the box and rusting the parts.

*(Source: ZERUST-registered trademark Corrosion Prevention Solutions Pamphlet).*



(Pic.13) *two separate boxes lined with an anti-corrosive plastic.*

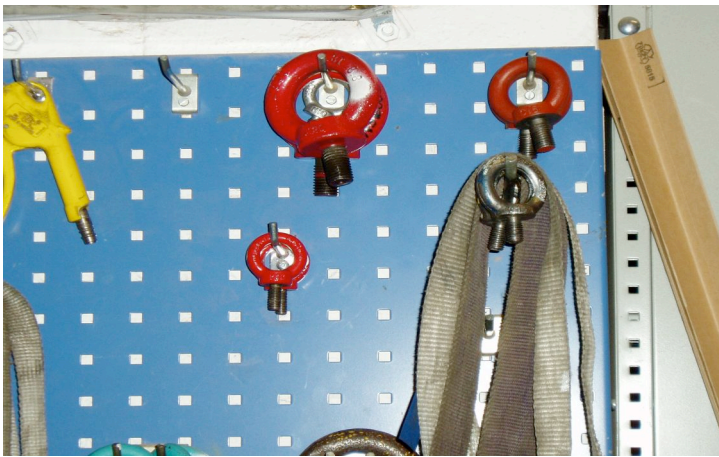

(Pic.14) *special rings and lines are used when handling and lifting the parts into the boxes*



(Pic.15) *the rings screw onto the parts themselves as shown above.*



(Pic.16) *if there is any empty space between the bushings and the bearings; they must be cushioned extremely well, preferably by using recyclable cushioning material.*



(Pic.17) *finally the boxes are wrapped with strong shipping plastic and attached on a pallet with heavy duty metal wraps. Package is then weighed, labeled and shipped.*

#### **4.4.2 Packing & Shipping bronze bushings and bearings using pallet frames Or in a singular parcel**

When shipping multiple bushings in one shipment they can be placed inside each other. However, it is imperative that they do not have any contact with each other. Bubble wrap, other cushioning material (preferably recyclable) and/or wood must be used to keep the bushings from shifting and moving during transportation.





(Pic.18) *three large bronze bushings placed inside each other on a pallet with pallet frames.*

Naturally, the plastic which prevents rust is a must. This way of shipping is also a way to recycle, since the bushings are placed on a pallet and pallet frames are piled as to make “walls” to form a package. All of the packing material can be re-used time and time again and this puts less strain on the environment.



(Pic.19) *cushioning material must be placed inside the bushings so that they will not touch at all, since bronze is extremely soft and one tiny scratch can make the part un-useful.*



(Pic.20) *plywood must be attached to keep any parts from moving during shipping even if the package accidentally falls upside down.*



(Pic.21) *the finished package is safe, neat and sturdy; it is wrapped on a pallet with heavy metallic wraps.*

#### 4.4.3 Shipping multiple bushings in a single box

When multiple bushings are shipped in a single box it is imperative again that the parts do not touch one another. A large plywood box is first lined with anti-corrosive plastic and the box is placed on a pallet. All the parts must be cushioned separately and several different compartments must be manufactured to immobilize the bushings in the box. The parts are so heavy that if not fastened securely they can shift and crash out of the box during transportation.



(Pic.22) *start with a large enough box to fit all the fragile parts.*



(Pic.23) *in this case a cushioned spacer ring is set on the bottom of the box.*



(Pic.24) *place the bushing inside the spacer ring and cushion the inside of the bushing well.*



(Pic.25). *special compartments are built inside the box to prevent the bushings from shifting during transportation. Heat-treated wood must be used.*



*(Pic.26) every single part that can be affected by moisture must be sealed in an anti-corrosive plastic.*



*(Pic.27) all the fragile and expensive parts are now tightly secured inside the box.*

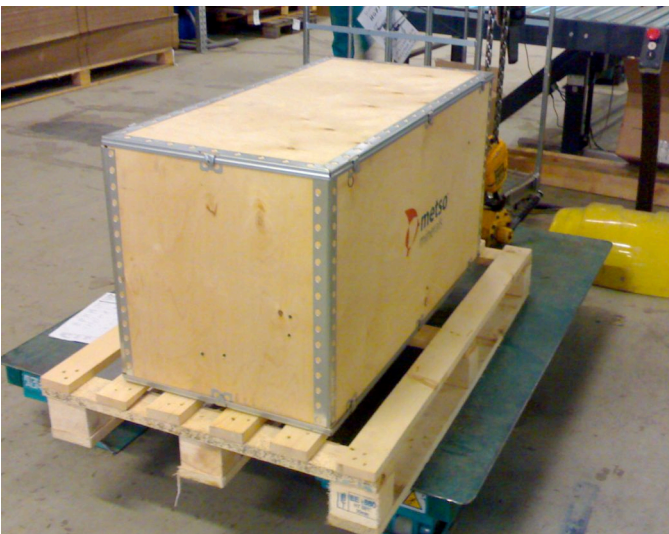

*(Pic.28) use a standard size pallet even though the box might be smaller. This guarantees that an optimal loading capacity is obtained*



*(Pic.29) a heavy-duty shipping plastic is wrapped around the entire box and fastened with metal cord straps.*

#### **4.5 Storing Bronze Bushings and bearings**

As the bushings arrive from the manufacturer they are unpacked in the warehouse. All information of the original shipper must be removed and Metso Minerals stickers are attached. The bushings are then placed on a pallet and the pallet is lifted on a shelf according to the information on the side of the shelving. This way the person who is picking the parts i.e. the picker, gathers the parts according to the sales department generated order. The part is then brought to be packed.

Bronze bushings and shafts are stored in the warehouse on a large shelf. The parts are well protected from being scratched or scraped. There is important information about the parts on the shelves and enables the picker to see the part number, the original shipper, weight and other vital information on the particular part. Most efficiently, the parts are stored on top of pallets. Picking is done on a fork lift.



(Pic.30) hundreds of bronze bushings and shafts in storage.



(Pic.31) metal shafts are stored on pallets for an easy pick up.

#### 4.6 Packing a Multi-shipment (including a spacer ring)

This chapter concentrates on a multi shipment of thrust- and eccentric bearings and a ring gasket. A heavy plywood box is lined with an anti corrosive plastic to endure shipping via sea freight and several pieces of specially stamped wood is built to prevent the valuable shipment from shifting during shipping. All the wooden material must be stamped with the IPPC stamp, which means that the wood used is heat-treated to prevent any pests and insects from spreading in global shipments.



(Pic.32) A large plywood box filled with multiple, fragile parts.

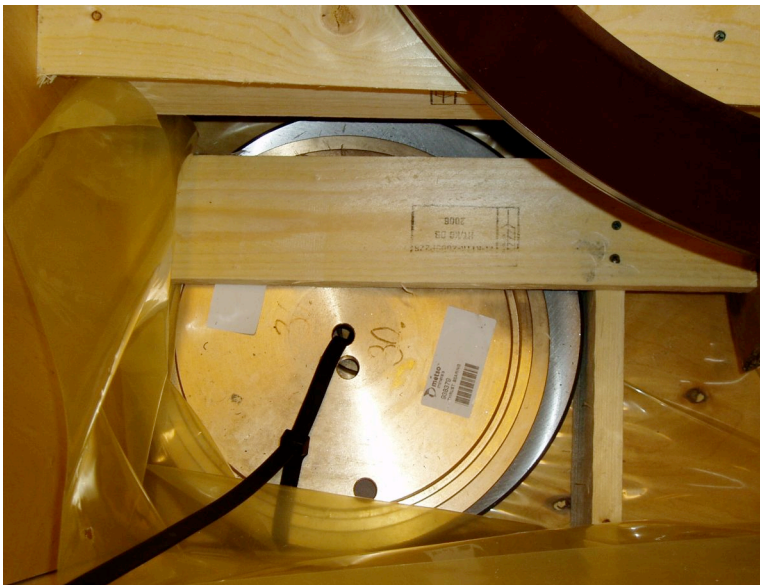

(Pic.33) a pressure holk and a tooth-wheel.

Pressure holks and tooth-wheels must be joined with cable ties. All these parts go together and therefore all the sub-assemblies must be store and shipper together at all times.



(Pic.34) *it is imperative to seal the anti-corrosive plastic tightly before the lid is attached to seal the box.*

#### **4.7 Packing & Shipping a torch ring**

A simple way to pack a part that needs to be protected from moisture is to wrap it in the anti-corrosive plastic and attach the part to a pallet with a heavy metal strap. The piece of wood acts as a protection for the part itself from the metal band and it is easy to write the part number, the country of destination and the weight on the wood itself.

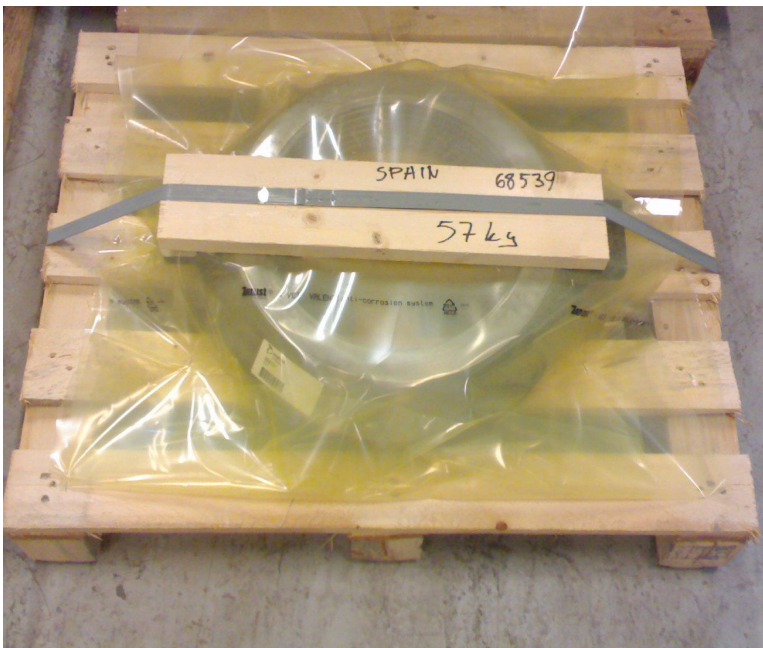

(Pic.35) *a correctly packed and protected moisture critical part.*



#### 4.8 Shipping Dangerous Goods and Hazardous materials

Hazardous materials such as paint and sealants must always be marked as dangerous with specific labels. Different countries have different laws on shipping dangerous goods.



(Pic.36) in this shipment (Macon, France) all dangerous materials are packed in metallic containers and plastic wrapped.

This wrapping also acts as a prevention of any possible leakage that might occur as well as keeps the shipment tightly bound together. Extreme detail must be used when labeling these shipments. Different materials have very specific codes and the shipper must also be aware of the regulations not only of his own country, but of the country of the consignee.

When shipping dangerous goods, it is imperative to be aware of the characteristics of the substance that is being shipped. For example, resin is not shipped as a dangerous good but hardener is. All the dangerous goods and hazardous material shipments need specific markings. Special labels are available and mandatory for haz.mat. shipments. (See section; labels)

#### 4.9 Packing & Shipping a Drive Pulley

A drive pulley is an extremely heavy, expensive and a motorized part. Special attention is required when shipping it. The first thing that must be remembered is to load a plywood box on a pallet. Once the part is in the box, a piece of wood must be sawed to fit into the box exactly. The wood must be heat treated and stamped with the IPPC code. This piece of wood nailed on both sides of the box prevents the heavy part from crashing out of the plywood box. The key is to have a piece of wood nailed onto the lower part of the box as well as the upper

part of the box. All spaces in between will be cushioned with a recyclable cushioning material.

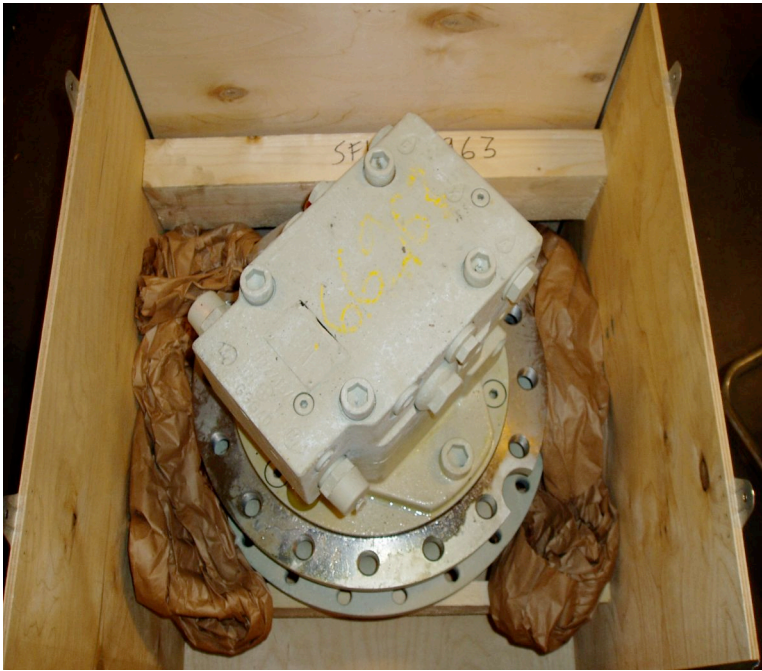

(Pic.37) a drive pulley pictured from above in a shipping box.



(Pic.38) eventually the lid is fastened and the metal cords are tightened around the box and the pallet.

#### 4.10 A Simple Way to Pack and Ship a Dust Seal

Part number, method of transportation, and a label sealed in plastic is easy to attach on to the pallet itself.



(Pic.39) the seal must be wrapped with an anti-corrosion plastic and a piece of a stamped wood should be attached on top of it so that the metal cords won't harm the fragile part.

#### 4.11 Packing & Shipping a Hammer Bolt and any long parts



(Pic.40) it is important to use a cushioning in between the layers when stacking up multiple long items in this case, hammer bolts.

It is also imperative to secure the ends of the box so that the bolts won't fly through the end of the box in case the shipment suddenly stops moving.



*(Pic.41) once the box is secured on a pallet and pieces of stamped wood are cut to protect the metal straps, the box can be weighed, labeled, invoiced and shipped out.*

#### **4.12 Packing a Fastening Item**

The pallet is securely on a scale. On top of a pallet there's a plywood box with the Metso logo on it. And the box is already lined with anti corrosive plastic for protection.



*(Pic.42) this is what every sea-freight shipment should look like before a part is even lowered in it.*

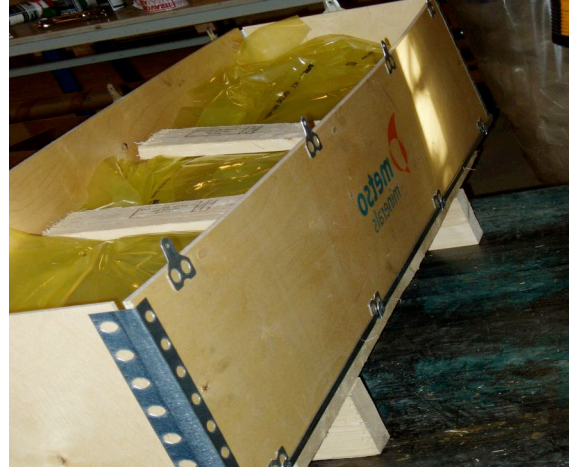

(Pic.43 & 44) *some heavy bolts are shipped with the steel structures. They must also be cushioned well.*

After the corrosive preventive plastic is sealed, IPPC stamped wood is nailed to hold the massive weight in place.



(Pic.45 & 46) *the lid is closed; the package is wrapped with shipping plastic, weighed, labeled and shipped.*

#### 4.13 How to Pack & Ship a Lifting Ring Safely



(Pic.47 & 48) *once the lifting ring is in the box, it can be cushioned with a regular bubble wrap.*

It must not be forgotten to secure the part in the box by nailing the piece of IPPC stamped wood. It must be remembered that the heavier the part, the more stability it needs, so there

might be several pieces of wood that need to be nailed just to hold this one heavy part in place for the duration of the shipment.



*(Pic.49) a perfect package should be leaving from every Metso Minerals' warehouse locations. Notice, that the picture does not include appropriate labels, invoices and waybills.*

#### **4.14 Wrapping Multiple Parcels in one shipment Boxes (Macon, France)**



*(Pic.50) multiple boxes can be shipped on a single pallet by wrapping plastic around the boxes to ensure they won't separate during shipment.*

When doing this it is imperative that the destination of the boxes is the same.

Each and every box is also required to have an address label and a waybill even though they are shipped as one shipment.

#### 4.15 Shipping Protection Plates

Protection plates and other parts like them are fairly simple to ship. The plates come in several different shapes. We will only examine two different types of plates. Parts, such as the protection plates, that are not easily rusted or broken and can take on a certain amount of nature's elements; they still need to be packed safely and effectively. It is important to be able to place other pallets on top of them to optimize the loading percentage of a container.



(Pic.51) *three protection plates resembling plow blades are attached on a pallet.*

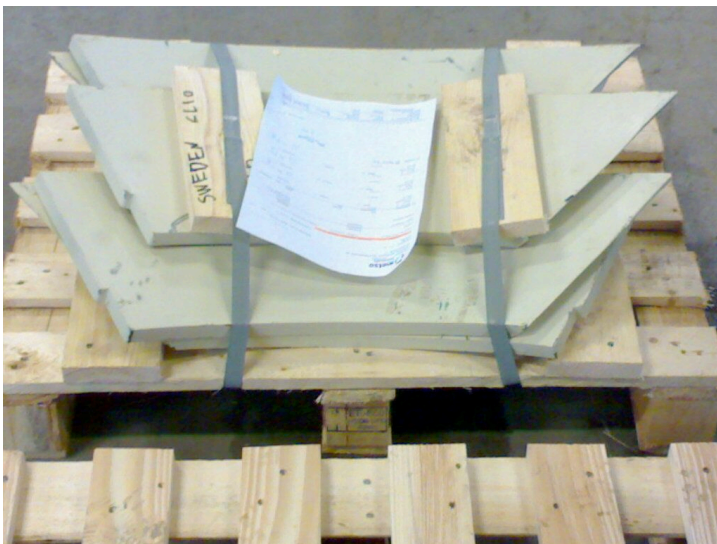

(Pic.52) *three protection plates attached flat on top of each other on a pallet.*

#### 4.16 Packing & Shipping Rollers & Gliders

The pallets that are used to ship rollers and gliders must be longer than the parts themselves. In the following photos we will look at two separate shipments. One is packed perfectly and according to the guidelines, and common sense. On the first shipment the pallet length exceeds the length of the rollers. On the second shipment the pallet falls short, thus leaving

the ends of the gliders to protrude further out from the end of the pallet. Interestingly both of these shipments were shipped from the same location. This instance again proves the dire need for an instruction-manual. There are many simple ways to prevent damages, claims, re-shipments, man-hours etc. This is one of them



(Pic.53) *two rollers set correctly on a long pallet.*



(Pic.54) *an example where the ends of the rollers stick out further from the end of the pallet and will most likely be damaged as arrived.*

#### **4.17 Packing & Shipping Parts with Screwed Ends**

There are numerous parts shipped in Metso Minerals that have screwed ends. One of them is called an eye screw. Below we will examine a few different alternatives on how to protect the jagged ends of these parts.





*(Pic.55) the end of an eye screw is already wrapped with saran wrap and tape.*



*(Pic.56) in this picture, which is a multi-shipment, the eye screw is on the far left.*

Parts with jagged or screwed ends can be saran wrapped and taped onto a piece of (IPPC) wood and shipped that way.



(Pic.57) two eye screws wrapped in plastic wrap and taped over wood.

In Macon, France, the shipping staff has come up with the most effective way to protect the ends of the parts with screwed ends. They use plastic netting in the shape of a tube.



(Pic.58) nothing else is needed to protect the end of the bolt. It is almost like a “sock”.

## 5 Manganese

Manganese is a gray metal that resembles iron. It is a hard metal and very brittle but easily oxidized. –This is part of the reason why Metso Minerals chooses to paint almost all currently shipped manganese in green. The oxidization or rusting does not prevent the use of this unique metal, but mostly the sole purpose is to please the eye of the customer. There are debates over painting the manganese parts in Metso, since after the part is painted the inner plate of a jaw crusher, for example, has to go through some crushing time so that the paint can wear off. When painted, the metal jaws become slippery and therefore possess less crushability. Manganese is sold, stored and controlled separately in Metso Minerals. Its symbol Mn can be seen in many separate and important global reports. Metso Minerals mostly controls the amounts of manganese bought and sold.

Even though manganese can be found as a free element in nature, it mostly occurs with iron and other minerals, it is a metal with extremely important uses in the metal industry today. Over 80% of the manganese supplies today are excavated in South Africa and Ukraine however there are significant deposits in China, Australia and Brazil, all locations that Metso Minerals has large operations bases. Interestingly, no other (satisfactory) metal can take the place of manganese in its major applications and no technology exists to replace this metal. In Metso Minerals manganese is mostly used in the interior plates of rock and mineral crushers. The surface that actually contacts the crushed material is mostly manganese. Hence the wear- and spare-parts that are presented in this thesis with a little more detail.

Sources: *Journal of Biophysics and Biochemical Cytology* 2, 799-802  
*Chemical Equilibrium Database and Plotting Software (2004)*  
*Royal Institute of Technology, freely downloadable software*  
[www.osha.gov/dts/chemicalsampling/data/CH\\_250190.html](http://www.osha.gov/dts/chemicalsampling/data/CH_250190.html)

## 5.1 Crushers & Jaws made of Manganese

Metso Minerals has a wide selection of crushers and gyrators. This includes large primary jaw crushers, primary meaning the rock goes through its first stage of processing, and small cone crushers for third and fourth stages of the rocks' process. The equipment is capable of making nearly every size product from fine, dusty sand to rocks that are left to large boulders. For example, when building a road, there are at least four different size rocks used.

The manganese that is examined in this work in more detail is imperative when the crushers are used. The jaws that perform the actual crushing process are manufactured from the manganese alloy. The lower jaw endures the most pressure on it therefore it wears out the fastest. The lower and upper jaw can be switched and it is recommended to be done to enhance the impact hardness. A jaw that is made of one piece is easily twisted this is the reason to manufacture the jaws from two separate parts. If at any point of the installation of the jaws they move or slide in the slightest way, they are installed incorrectly. The jaws are also tightened in a certain particular order to avoid any movement or in the worst case scenario and accident or a breakdown of the machine.

When attaching the jaws the settings determine the size of the rock that comes out of the crusher. A close side setting, when the moving jaw is closest to the fixed jaw, produces the smallest grain of rock. In other words the size of the desired rock size is determined by the variation of the open and close side settings of the jaws. (O.S.S = Open side setting and C.S.S = Close side setting). The length or the stroke, for example 25 – 50 mm, is adjusted according to the size of the crusher.

OSS-CSS=STROKE

The eccentric axle moves approximately 8-16mm. There is also a moving half slide due to the heat that is generated by the friction of the movement. All the bearings are built so that no dust can gather there. Dust could cause friction and prevent or alter the movement of the bearings. This is one of the reasons that make all the wear and spare parts extremely expensive.

Things can also go wrong for many other reasons. For example the toggle pin can bend if a fuse or a safety rod gives out. In another scenario especially when cleaning out a demolition site, iron can get fed into the mouth of the crusher. This can be prevented with a hydraulic push plate. Tension rod and an intermediate plate can be placed behind the jaw. The intermediate plate requires longer bolts.

A general rule is that the smaller the mouth angle the better consumption throughout the entire surface of the jaw.

All the crushers are known for the fact that none of the parts are welded together. This makes it easier for assembly where ever the excavation site might be. The only exception to this is the core crusher from Sandwick which is welded together

The manganese jaws are only manufactured in Tampere, Finland, China and Brazil.

Metso Minerals is the largest manufacturer of jaw crushers in the world.

Normally, the jaw crushers are called C-series crushers and carry the name of Nordberg from early Metso Minerals' name. The crusher consists basically of four separate jaws that are set in the crusher with bolts. This way no welding is needed. Since the crusher lacks the usual welded seams that normally cause a huge stress on the machine, there are fewer breakdowns on the machines. The bolting also ensures a larger reliability under severe crushing conditions and enables the different sets of jaws to be switched with one another and turned upside down. This, in turn, prolongs the product life time and usability.

The crushing function is based on the movement of spherical roller bearings and an eccentric shaft. The C-series crushers are divided into two separate models. First one is designed for stationary and mobile functions and the second model is directed to small to medium sized mobile crushing. All C-series crushers are made to crush very hard rock.

Special attention has been paid when designing the cavity of the crusher. Since the "mouth" of the crusher is one of the most important factors of the crusher, the cavity dimension of the C-series crusher can be adjusted. The right sized feed opening and width-to-depth ratio ensures less blockages and eliminates unnecessary height from the crusher.

In addition to the correct dimensions and the right setting of the "mouth", correct kinematics need to be applied. A large stroke, which is easily manually adjusted, with a fast speed of the flywheel combines a successful and high performance in the crushing process.

Many different types of jaws are casted for several different types of crushing applications. All jaws are positioned in the "mouth" of the crusher. The "mouth", also known as the feed chute, contains the jaw and the cheek plates made of manganese. The jaw and cheek plate removal or repositioning can be done with a stationary chute. However the chute can be taken down for maintenance and other purposes. As the jaw bangs, or strikes, on the stationary side of the chute, the entire crusher is allowed to move and pivot according to the eccentric shaft,

vertically and longitudinally. Special rubber stoppers prevent wear and tear to the foundation of the machine.

A customer long time ago had a need to move the crusher to a different part of the quarry as the excavation proceeded. As a C-series crusher was mounted on top of a track belt, a whole different product group was designed. Lokotrack product line was born. To have a mobile crushing plant makes the moving of the equipment to the rock face much more flexible and eliminates the need for haulage trucks. This means lower material transport costs, less dust, noise and exhaust emissions which in turn creates a safer and cleaner work environment.

Mobile equipment in excavation and mining is a rapidly growing business trend. 20% of Metso Minerals' market consists of selling mobile equipment and the sales are up. The sole providers of equipment such as Lokotrack in the world are the United States and Metso Minerals in Finland. The greatest advantage in having a mobile crushing unit on site is that haulage is practically eliminated. There is also hardly any waste produced and dozens of trucks and back hauls are made redundant. This of course limits the exhausts released into the atmosphere, making it less polluted.

Another, differently shaped crusher and its parts are examined a little closer. The manganese cones or mantles act as jaws in a gyratory crusher. The function is based on a main shaft that moves up and down with the assistance of a hydraulic system in the base of the crusher. Gyratory or cone crushers act as primary crushers as the Nordberg SUPERIOR or smaller versions of them such as Nordberg GP, HP or MP models are used when making the end product, for example sand. By changing the eccentric throw the crusher capacity can be matched to a plant's crushing requirements. All is based on the settings of the eccentric bushing where as the same is achieved in the jaw crushers by adjusting the toggle plate and the angle of the feed chute.

Cone crushers are mostly used as primary or tertiary crushers. The rock is measured by the dimension of the primary stone. The feed opening varies in the separate parts of the chamber of the cone. There is an inner and outer mantle inside the chamber. The lower mantle wears up faster since the eccentric axle causes fillet in the lower part of the cone. So in this case the  $STROKE + C.S.S = O.S.S$

The upward movement of the axle divides the wear equally on to the entire surface of the manganese that surrounds the cone. The wedge for the crusher should always be sold in the

company of the upper mantle. A torch ring and the dust filter should also be included. In order to provide a different type of stroke the bar can be switched.

When the correct flow of oil and heat and the right amount of pressure is achieved the crusher can then be started.

*Source: Product support training in Metso Minerals 2006*

## 5.2 Storing manganese



*(Pic.59) mantles that go inside cone crushers are stored with metal wraps and plywood.*

Plywood is necessary to protect the metal to metal contact. Manganese is soft enough to be damaged by the tight metal wraps.

In 2006 a global project was launched to instruct the warehouse staff of the proper way to store manganese. Posters, translated to each country's own language, were delivered to numerous countries and instructed to be hung on the warehouse walls. The project was received with great enthusiasm.

## You are responsible for proper care of inventory

**NOT LIKE THIS**



**BUT LIKE THIS**



(Pic 60) Metso Minerals' promotional poster





(Pic.61) if plastic wraps are used while storing the parts there is no need to use plastic corner protectors or sheets of plywood. (Cones/mantles for a gyratory crusher)



(Pic.62) manganese jaws are stored and shipped in multiple quantities. They can be turned upside-down and re-used in the crushers to maximize use. (Jaws for C-series crushers)

When storing manganese it is important to make sure that the pallets the parts are stored on are strong enough. It is also good to wrap the parts together.



(Pic.63) a box stored and shipped with two manganese cones. Heavy-duty wraps keep the shipment sturdy.

Interior plates for a jaw crusher are safely and easily stored and shipped. The corners are protected with plywood and the ship-to location is marked on the wood.



(Pic.64) two manganese jaws for a jaw crusher (c-series).



(Pic.65) red and green mantles, jaws and cheek plates stored in Macon, France.

Some parts are painted a different color depending on the customer's request. Special cranes and strong lines are used when lifting the parts to the pallets or for storage.



(Pic.66) special lifting tools in use. Notice the stacks of manganese mantles on right.

### 5.3 Shipping Manganese

When shipping these extremely expensive parts, special attention must be used in the way the manganese parts are stored but also when they are shipped. The parts usually weigh several hundred kilograms. They are fragile and expensive. One might not think of a metal part this magnitude of being considered fragile, but due to the softness of the metal, the parts are easily damaged, especially during shipping.



(Pic.67) *it is important to protect the manganese part from the metal wraps (cords).*



(Pic.68) *this can be done with a piece of wood that has a groove in it for the wrap.*



(Pic.69) another way to ship manganese cone mantles is to build a specially sized box.

This, however, is more often than not necessary, and borders on over-packing. (Please refer to section, titled Over-packing) Manganese parts are widely (in Metso Minerals) considered to be well packed and shipped when wrapped on a pallet. Other shaped manganese parts are also shipped in a box custom built to fit them. These parts are plates, also made of manganese.



(Pic.70) side plates shipped in a specially built box.

## 6 Damages due to Packing

When packing a heavy or expensive part, one should always take into consideration the common sense aspect of will the part hold and last the shipment process. Most of the time the part shipped usually goes to a truck in the beginning journey of the shipment, but will eventually be handled in harbors and containers all over the world. If the part does not seem to be covered to the extent where one would see it holding until it reaches the destination, usually the customer, they should do everything in their power to re-define the packing process. Even if a manual is used, extra measures can and should be taken into the packing process as a whole. This means that they are mostly guidelines and suggestive. If a part does not appear to be packed in the most suitable way for that part, the packing should be either re-enforced or reduced. A special and careful consideration must be used when reducing packing from a shipment.

All damages lead to a delay of the project or other process the part is intended to be used in. This always leads to a concern on the part of the customer or the end receiver. That, in return shows as a decline in customer related retention or over all customer satisfaction and other surveys made. To keep a customer is a core issue to all businesses. Even with all customer related service departments and customer oriented management, the retention of customers is affected by the staff that packs the parts for Metso Minerals.

If damages occur and they are avoidable by paying special attention to packing this can be changed. In the worst scenario, a customer has a break-down on a site that has for example a crusher. The customer orders a new part for the crusher that has broken down and is now preventing the entire supply-chain of that mine or an excavation site. If the customer gets a part that has been damaged in a shipment only because the person who packed it doesn't take the time to make sure that the package will last the shipping process, it is extremely likely that the customer will issue a complaint.

*Source: Innolink for Metso Minerals  
Damage reports from South Africa and USA*

## **6.1 Examples of common mistakes when packing**

The most common damage will occur due to a lack of sufficient packaging. Some of the most common damages are examined in the following chapter. Most of these occurrences could have been avoided if a shipping manual was in use. However, some times the use of common sense could have prevented the damage from taking place. It is important to share the knowledge of sufficient packing throughout the warehouse. If someone is trained in packing or has a longer experience in packing these parts, they should share their practices with others in the warehouse. This way a lot of the usual mistakes could be avoided. Human errors are the most common mistakes that are made in the packing process. People get careless and make mistakes when they are in a hurry, especially when time is of the essence and pick-up deadline is pressing.

### **6.1.1 Some of the main problems in packing**

- Conditions of the arriving parts
  - Packaging is poor and the parts arrive to the customer or the end user, rusty.
  - Parts sometimes arrive without part numbers.
  - Parts sometimes arrive with the competitor's part number and even name.
  - Some parts arrive separately but are sold as a kit.
  - Visual changes in parts are not notified.

A possible solution to the problems of arriving part is that as the receiving department prints out a list of all the parts that arrive that day, by having a specific name either on the packing list or on the actual package would make finding the person who the package is for significantly easier. This person could then be contacted by telephone or e-mail

- Problems in delivering the arriving parts
  - Pick up and delivery times are long.
  - Delivery costs are too high.
- Drive device
  - Product life time is short but delivery time is long.
- Jaws and other manganese parts
  - Parts shipped from Finland take a long time to arrive to countries in the Southern hemisphere.

## **6.2 Direct feedback from Metso Minerals' Tampere warehouse**

There are some variable opinions and heated debates and discussions held in the Metso Minerals' Tampere location about whether to paint the manganese cones only to please the customer's eye, some employees believe that the ordering of specially made boxes would be cost-effective in the long run and create unity in box appearance and durability. It is also a big question mark for some employees why the pallets are still being ordered from Estonia. Due to their poor quality and easy breakability a solution is desperately wished for.

### **6.2.1 Special boxes**

Iron-reinforced plywood boxes could be made or the production could be outsourced or bought from a third party for the unusually long items. It would improve customer satisfaction by reducing damages and prevent the different packing departments from having to "compose" a package that is never uniformed. This would be extremely valuable when packing i.e. shafts and axles.

### **6.2.2 Painting vs. nature**

If, and since MM paints most of the wear and spare parts only to please the eye of the customer, i.e. for a cosmetic value, why are the painted parts (like manganese jaws) the same price as the unpainted ones? As MM is heavily emphasizing a new business line called Recycling, the company would release a lot less pressure on the nature by leaving the parts unpainted. Even if the parts look "prettier" painted thus selling better, the paint eventually ends up in nature as it is worn off the part. The paint makes the crusher jaws very slippery therefore it often must be removed before the crusher works properly. The removal is always done by running the crusher several times. It is also been reported by management that the painted parts sell better and the competition paints their parts. Customers are used to getting a wear part that is painted and looks "clean" and "pretty". The market dictates the price. Unfortunately MM is unable to discontinue painting the wear parts, and even makes advertisements of it with proud. The United States of America even puts a coat of paint into the side plates that are not even visible to the customers' eyes.

### **6.2.3 Problems with Russia**

Sending packages to Russia has been a problem for a long time. The bureaucracy there is very different from the EU and sometimes worse than anywhere else. The warehouse in



Tampere, Finland is forced to pack boxes weighing less than 200kgs so that the packages won't be stolen once across the eastern border.

Trans-Siberia;

Russia is constantly upgrading its tariffs. A large part of the machines from Metso Minerals that previously were shipped via railways are now transported in ships. Contrary to the train traffic controllers in Russia, the sea cargo has decreased tariffs so it is more cost-efficient to ship the equipment via sea-freight. The major problem in this way of shipping is that the Trans Siberia is much faster in comparison to the sea transportation. The transportation of goods between Europe and Asia takes up to ten days longer when shipping them by sea.

### 6.3 Heavy items on top

A small thing like placing a heavy part on top of lighter parts in the same box can cause a part to be damaged. Here a shipper had put a heavy part directly on top of a box with fillers in it. The heavy part had caused the light filler box to dent thus damaging the fragile filler and caused it to lose commercial value.

The common sense that all people possess should be the first factor to consider. A manual can guide the warehouse staff on problematic shipments but it should not be taken as the only possible way to ship an item. A person's own ideas and preferences should also be taken into consideration.



(Pic.71) a heavy item on top of a filler box.



(Pic.72) dented filler boxes.



(Pic.73) a hollow box damaged by the weight of the heavy part.

So far we have examined a damage that has occurred due to a packing practice that lacks so called common sense. Even if a manual is used, there is no knowledge that can be acquired from a book or instructions that replaces the use of common sense. Heavy items should always be packed on the bottom, or in a separate box if so determined. The reason Metso Minerals uses a special plastic that prevents corrosion is obvious when looking at the following pictures of damaged items. These parts are heavy and very expensive. They usually include shafts, bearings and motorized parts.

#### **6.4 Rusted main shaft**

When packing a main shaft, the center part of a crusher, for sea freight transportation it is imperative to use the special, rust preventing plastic. Next we examine a case where a main shaft has been placed in a box without any protection, and the entire shaft has rusted. As a customer receives a package holding a rusted shaft, the plant has usually been in a complete stand still. The customer now has to fill out paper work for the damage, order a new part and wait for the replacement part to arrive. This can take a long time and every hour that the plant stands idle, costs vast amounts of money. It is also inconvenient. Metso Minerals' parts are not replaceable. This means that no other parts can be used in the crushers than parts that are supplied by Metso Minerals.



(Pic.74) a rusted main shaft shipped without anti-corrosion plastic, cushioning or immobilizers.



(Pic.75) a rusted part shipped without anti-corrosive plastic but with some recyclable cushioning in the bottom.



(Pic.76) inadequate packaging.



(Pic.77) inside inadequate packaging.



(Pic.78) *a damaged box.*



(Pic.79) *a rusted cone.*



(Pic.80) *a dented main shaft.*



(Pic.81) *a scratched main shaft.*

As an improvement idea, the main shaft (above) should be wrapped in a corrosion preventing plastic and cushioned before placing it in a shipping box. Side bars should then be built to stabilize the shaft.



(Pic.82) *a main shaft in a cushioned box.*



(Pic.83) a main shaft with cushioned side bars to immobilize the part.

## 6.5 Damaged roller assemblies

Although the screwed edges were correctly covered with the tubing (please refer to picture number 53) the vital, anti-corrosive and rust-preventing plastic was completely disregarded in this shipment. The parts, in this case the roller assemblies, were placed in a box without any cushioning material at all. During the freight in the sea, the parts were completely rusted thus making them unusable. A simple procedure during the packaging process would have prevented this damage, and saved both parties, the company as well as the customer time, money and aggravation.



(Pic.84) rusted roller assemblies arrived to customer as damaged.

## 6.6 Using metal cord straps

It is most important that when heavy duty metal wraps are used, that a piece of wood or plastic needs to be placed between the strap and the part to protect the part from the metal strap. The wood needs to carry the IPPC stamp and be heat-treated and/or fumigated. However, placing a light box under the tight wrap is not wise. In this instance the package was leaving a warehouse and had not yet reached the customer. To prevent further damage, the warehouse personnel should have re-packaged the shipment.

MM in South America Brazil has run tests on cord straps made of different materials.



(Pic.85) a box is bent because the strap is tightened (Pic.86) the strap crushing the box too tight.



(Pic.87) even plastic wraps can damage the box if tightened too tight.

## 6.7 Severely damaged main shaft

In this incident the shaft has properly placed in a plywood box with multiple supportive elements appropriately preventing the shaft from moving during the transportation. There is no cushioning and again, the rust-preventing plastic is missing. Judging by the condition of the part, it has also been severely scraped during the shipment. Further investigation of picture number 80 shows a deep scratch on the side of the part. A scrape such as this makes the part completely unusable even if the part was not so badly corroded.

An outside partner, such as PP Logistics in Lempäälä Finland manufactures proper boxes to ship main shafts. To achieve the best possible result in shipping soft metal shafts, they should always be shipped upwards instead of sideways in a box.



(Pic.88) a rusted and scraped shaft.



(Pic.89) a deep scratch on the side of the shaft.

## 6.8 Damaged plates on a pallet

Long parts should always be placed in a plywood box, especially parts that cannot be used if they are rusted. In this case the parts have been laid on top of a pallet (sideways) and poorly attached with thin metal straps. It is obvious that this particular shipment takes up double the space in a container and nothing can safely be loaded on top of it in order not to bend the protruding ends of the parts. When shipping parts that are prone to corrosion, there is no way to protect them on a pallet. If they were put in a box with appropriate cushioning, the anti-corrosion plastic could be used to prevent corrosion. Here they are completely exposed to the elements.



(Pic.90) *rusted parts placed sideways on a pallet.*

## 7 Improvement ideas on packaging, shipping and quality assurance implemented in ERP

To examine the causes of damages it is important to make sure that the parts are protected accordingly, to ensure that the parts are packed in a way that is safe, easy and fast for storage and handling. It is imperative that the parts are packed in an efficient way for transportation and loading, cost and wood material should be reduced, the parts movements are secured by employees that handle them and a standardized method of packing should be used.

A model of standardizing a package and implementing it to the ERP system;



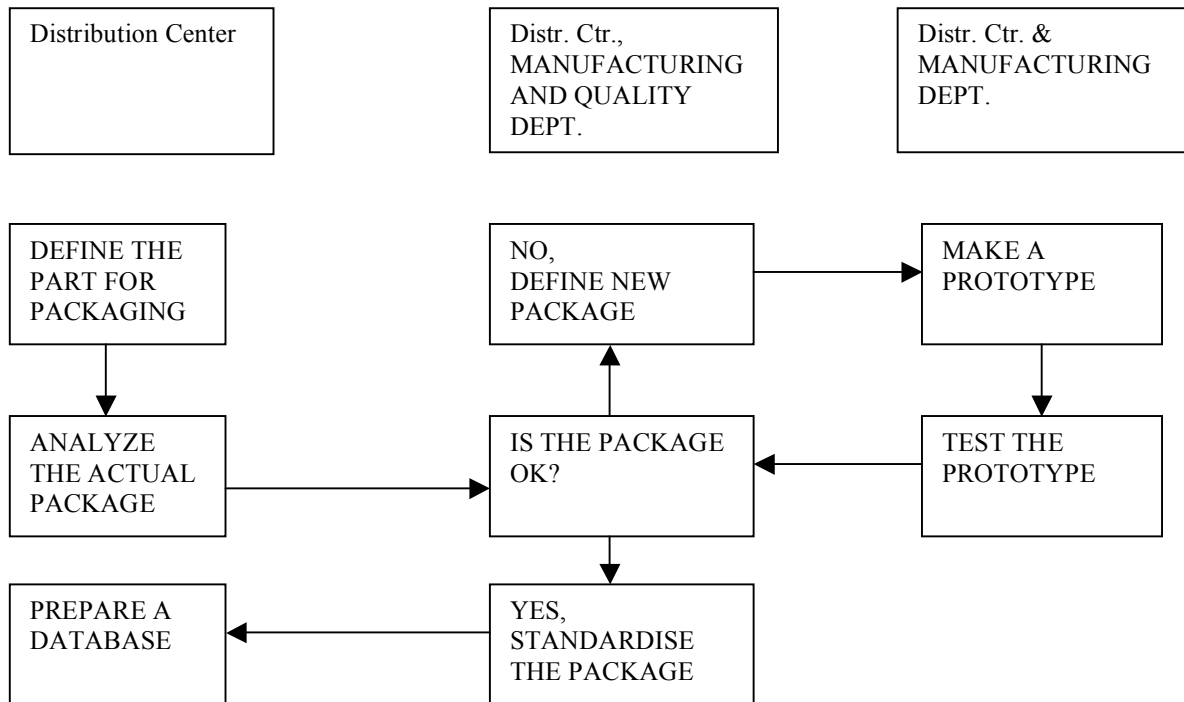

*(Table 3) Model of package testing system*

The distribution center should first define a part that needs a standardized way of packing. The package should then be analyzed and determined whether the packaging is sufficient. If the packaging needs further development, a prototype of the packaging should be made. The prototype should then be tested and again, determined to meet qualifications. Once the part is sufficiently packaged, a standard should be made of that particular way of packing that part. All standardized packing methods should then be added to the ERP database.

### **7.1 An improvement idea for shipping a main frame**

A main frame was delivered to a distribution center from a supplier. It arrived on a small pallet. An improvement idea for this shipment is that the frame should be on top of a larger pallet even if a special size pallet must be made specifically for this shipment. A lot of thought is put on the pallet sizes in Finland, and mostly only three different sizes are used. There are parts that still need a larger size frame or pallet built due to the size or weight of the part. (Please refer to picture number 6)



(Pic.91) main frame (HP 800) arrived DC on a small pallet.



(Pic.92) the same main frame on top of a specially built frame with corner locks.



(Pic.93) heavy duty corner bolts to stabilize the main frame.

## 7.2 An improvement idea for shipping a drive ring

By shipping a drive ring flat on a pallet costs more money than to ship it slightly elevated. A drive ring can be almost two meters in diameter so a specially built pallet won't guarantee an arrival to the customer damage free. It also takes a lot more space in a container and a truck when it is lying on its side. Therefore it pays to build a rack where the ring can be placed on an angle. The possibility of damage is smaller since nothing can be placed on top of the ring thus crushing or bending it.



(Pic.94) a large specially built pallet that shouldn't be used to ship a drive ring.



(Pic.95 & 96) a specially built rack that minimizes the transportation cost of shipping a drive ring on flat pallet by US\$ 3950, 00 according to calculations in Brazil.

## 7.3 An improved idea for shipping a mantle

A mantle is a heavy manganese part that causes a lot of stress when being shipped. The part must be protected from scratching and due to its round shape is hard to ship stable. In the following example a mantle is shipped on a special rack. However this rack made the part slightly too high which in turn increased the shipping costs. Therefore the basic idea of the shape of the rack is very good; it just needs to be built slightly lower.



(Pic.97) a red rack built to carry the heavy weight of a mantle.



(Pic.98) straps can be attached to the rack around the mantle stabilizing the heavy and expensive part.

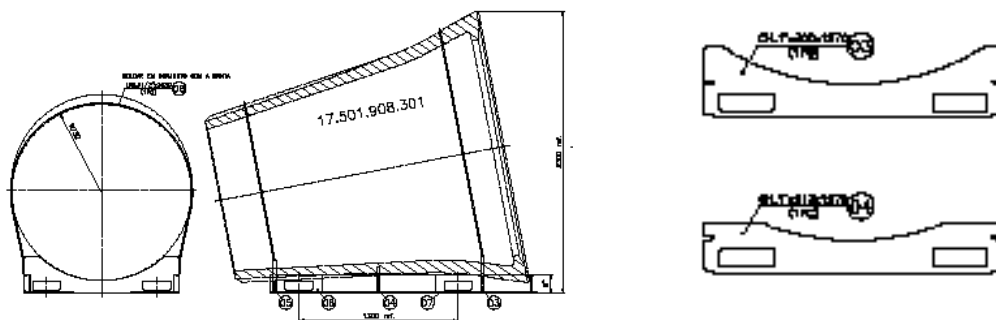

(Pic.99) drafts with dimensions of the mantle and the rack.

## 8 Implementing packing information in the ERP system

Implementing packaging directives to the ERP system that is being used at any Metso Minerals location, can serve as a great help. Unfortunately SAP is currently only being introduced in Europe but is already in use in the United States. There is no unified ERP system in use globally. However, by incorporating shipping instructions to the system under the specific part number can be of great assistance when packing the part. This has already been a trial in South America. Following are examples.

Start by choosing the equipment line in the system used. After this the country code can be clicked and then the part number. Under each part number a separate shipping instructions window would open and there would be brief instructions and pictures on how to ship that particular part.

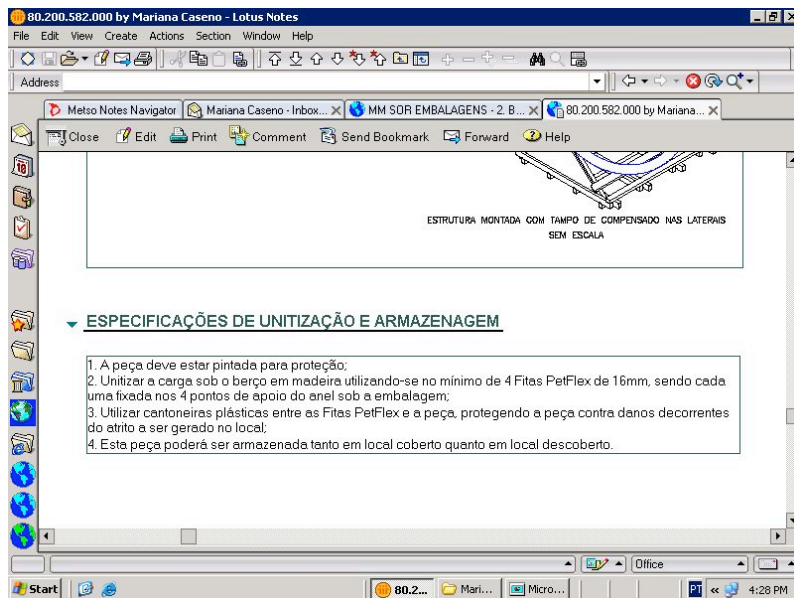

(Pic.100) a brief instruction on how to ship a drive ring.

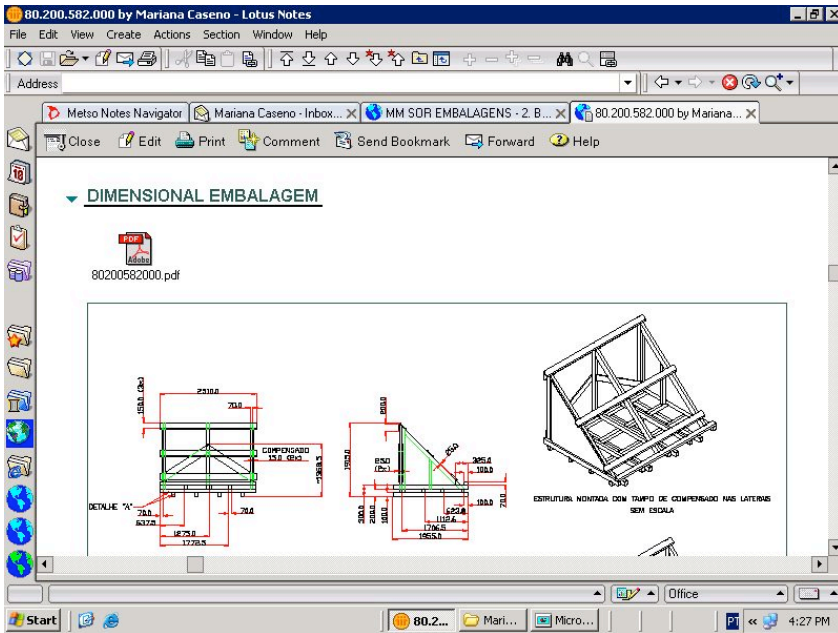

(Pic.101) information in the ERP system. on how to build the rack for shipping the drive ring.

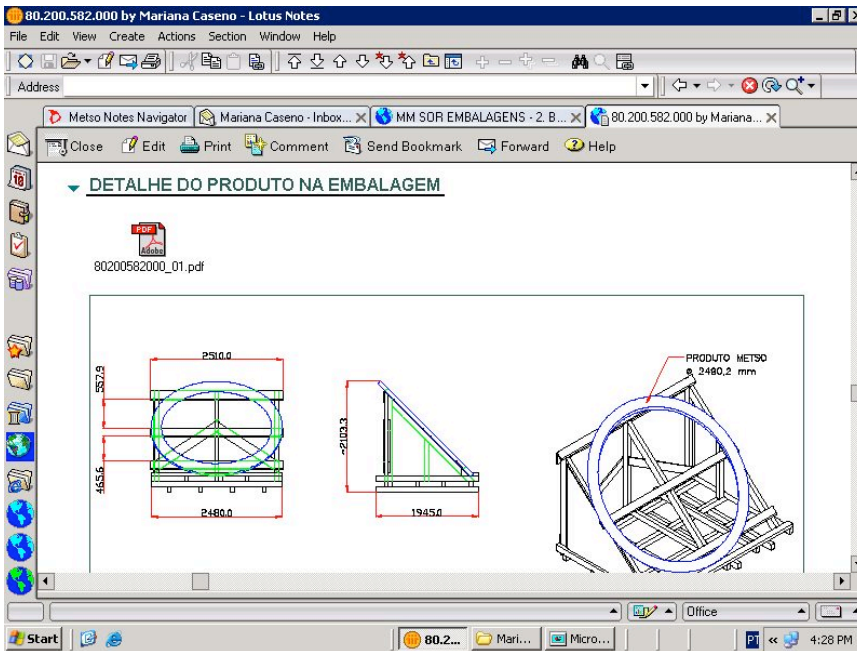

(Pic.102) information in ERP system on the dimensions of the rack for the drive ring.

## 8.1 Improvement ideas for lashing manganese using cord straps

Every time wood is used in shipping parts, the wood has to be heat treated and fumigated with the IPPC stamp. To eliminate the weight of the wood and difficult construction, cord straps can be used. A special polyester cord has been manufactured in South America, Brazil and tested in shipping. It is lighter, more flexible and stronger than wood. Polyurethane is also a possible material to build cord straps.



(Pic.103) *using wood in lashing is often awkward, heavy and unstable and the wood needs to be IPPC approved.*

Since the container is billed on weight and dimensions by using wood the cost of the shipment is higher.



(Pic.104) *by using cord straps made of high tenacity polyester filament with a polymer coating in lashing the cargo, it offers high abrasion resistance and the highest possible joint efficiency in the buckle.*



(pic.105) cord straps are often referred to as “synthetic steel”. Brazilians have made brilliant work in development of these special lashing cords.

By using strong cord straps several parts can be shipped on top of each other and the use of wood becomes obsolete. This also makes the shipment significantly lighter and increases the container capacity. Multiple tests have already been carried out in Brazil. The factors that need to be evaluated are for example the cost/meter, re-usability of the strap and does the cord strap stretch in use. Safety is again the main concern before introducing a new packing product into regular use.

## 9 Improvement ideas for all critical parts

The reason why improvements and new ideas should be introduced in the current way of packing is that there are no unified or global instructions to pack parts that are the same all over the world. Metso Minerals or its dealer agents are the only suppliers of the parts that are unique to the crushers MM manufactures. Metso Minerals is globally shipping the same parts all over the world daily. A global manual would provide a valuable guideline on the way to pack. The shipments would be consistent, damages would be minimized, customer satisfaction would improve and precious lead time would be saved. The amount of different ways to pack the parts is equal to the amount of warehouses preparing the packages and shipping them.



## **9.1 Shipping concerns in Brazil**

A visit to Metso Minerals location in Brazil brought up the following concerns:

### **9.1.1 Condition of arriving parts**

- Packing is insufficient and parts are damaged or rusted
- Parts are arriving without part numbers.
- Parts that are sold as kits (ready for assembly) arrive separately or in completely separate shipments.
- The receiver is not informed of changes of vendors and/or visual appearance of parts' changes.

### **9.1.2 Matters of deliveries**

- Pick up or delivery times are too long.
- Delivery costs are too high.

### **9.1.3 Matters of specific parts**

- Drive device: the life cycle of the part is too short in comparison to the long shipping availability time or delivery time.
- Filters: part numbers are missing on some manuals for breathers. (Breathers are located on the conveyor gearboxes.) Original breathers assembled by Metso included manufacturers' part numbers. This information is imperative on the local level. Prices of the filters are too high. In comparison to a local dealer (Donaldson), MM price was five times higher.
- Jaws and other manganese parts: Parts imported from Finland last 20 - 25% longer than the parts originating from Metso Minerals, South America.

Source: Logistics manager in Sorocaba, Brazil

## **9.2 Improvement ideas for Macon, France**

A visit in Metso Minerals location in Macon, France headed improvement ideas. The following ideas and suggestions were discussed with the warehouse manager. National and international shipments were looked at. Also road, sea-freight and air-freight were considered. Types of shipments were defined as standard, express or breakdown. A breakdown shipment is crucial when a part needs to reach the customer as soon as possible

due to a breakdown of a crusher on an excavation site. The entire site can stand idle due to a breakdown of one machine.

In shipments that are destined for France or are shipped and delivered within the EU, the Metso Minerals warehouse staff is left to decide what sort of packaging is sufficient. This is due to the lack of a standard packaging instructions or a manual. In an international shipment, the MM France wanted to outsource the packaging procedure. Among other benefits, MM would be able to hold the outside company liable for damages due to packing. Feasibility studies would have to be made to further continue outsourcing to an outside company to ensure profitability. In reality, a centralized Metso Minerals warehouse has since been built to Belgium (LEP project) so critical shipments are no longer a concern for the MM warehouse personnel in Macon. In an exceptional case of a critical shipment by air-freight, special lightweight boxes should be manufactured.

The warehouse staff in France would be issued some standard instructions. They were to use standard packaging. They would also be required to double-check the shipment for the quality and quantity of parts. Reference numbers should be written on each part. In case the part numbers get unattached during the shipment, a reference number written on the part itself would ease the shipping process. Parts should be wedged in plywood boxes only with IPPC stamped wood or other completely recyclable cushioning material. Parts should always be protected against corrosion. Each parcel weighing more than 20Kgs should be able to be handled with a fork-lift. Special attention should be paid to writing the shipping details on the package. This information should always contain the order number, net weight, gross weight and the country of origin.

*Source: A meeting with the warehouse manager in Macon, France*

### **9.3 Improvement ideas combined from MM and Valmet**

Valmet and Rauma became a part of Metso conglomerate in 1999. Currently Valmet Automotive manufactures mainly cars such as Porches. It also has a long history in manufacturing diesel engines, buses, airplanes, rifles and other arms, paper machines, sauna stoves, industrial elevators and field and forest machinery. Valmet possesses hard criteria in the directives when choosing a package for a shipment. The packaging acts as a protection of the material shipped throughout the entire logistic chain.

The criteria for a unit packaging are:

- It must protect the parts from damages between the shipper and the consignee.
- If possible, the same packaging should be used as many times as possible, whether the package is shipped within Metso or between Metso and the customer or end-user.
- The package should be made so that handling of the package can be minimized, thus elongating the life cycle of the package.
- The handling of the package should be enabled with standard equipment such as conveyors, trucks and shelves.
- The cargo should be minimized when considering the cubic meters per truck and the packages should be stackable.
- $\text{Cargo} + \text{investments/the unit cost} =$  a safe formula to use to decide whether a unit packaging is used.
- The packaging and all the packing materials should be recyclable.

Due to multiple MM warehouse locations the amount and the types of packages are different everywhere. This is why the information flow between the shipper (MM) and the receiver is so important. The dealer agents and customers that need to return parts are provided with specific instructions on how to pack the parts for the return shipments. Special directions on packing instructions are incorporated into the ERP system. This can already be done when designing the special packaging for a critical part.

Different departments are included into the consideration of possible changes in the packaging process. Everybody should assume responsibility of monitoring the condition of the packages. As faults in packaging are noticed they should be reported to the person or people planning the packages who will then notify the shipper in writing. Everyone should also be responsible in monitoring the safety and functionality of package handling equipment in the logistical chain.

If the quality of the packaging is compromised by the packing method it should act as a cause to an immediate change in the packaging methods. The change in packing methods is then immediately reported, in writing, to the party responsible of shipping the part. A revised method of packing is then approved after being tested and test-shipped by the part originator.

*Source: A collaboration meeting with Heikki Kivijärvi, the Logistics Manager MM, Tampere*

## 9.4 Planning a standard package

There are several things to be taken into account when planning a standard package. When planning the standardization of the packing processes the measurements of the parts play an important role. Stackability and ease of use are as important. This is why the parts designing department and the package designing department should work closely together. Also cooperation between the package designing department, the production line, the quality department and the outside supplier of parts is imperative. However, maybe the most important factor in designing a standard way of packaging is that the shipment's measures are optimized in such a way that the trucks and containers can be loaded fully to their capacity. The amount of racks needed, for example for manganese jaws and mantles, can be obtained by calculating the need for parts/day x the turnover / parts/rack.

### 9.4.1 Stackability

The ability to stack the parts in a rack or other package on top of each other is extremely important. That defines the fill percentage of the truck or a container. For example, there are metal racks in use in other parts of Metso that could be suited for use in Metso Minerals. Crusher jaws or mantles could be stacked on top of each other in the racks and then the racks can be stacked several high in the container of the truck.



(Pic.106) *two corners of metal racks piled on top of each other.*

Another example of stackability is these lower racks for different kind of parts. These are in use at Metso Valmet Automotive department



(Pic.107) low racks piled on top of each other.

In order to avoid any unnecessary changes to the packing methods the package design department should also be in close contact with the users or the racks. This would guarantee a seamless cooperation between the internal and external logistics. It is important that the people who are physically in contact with the racks and other packaging can have a voice in the logistics chain. A form for inspection and approval could be taken into use.

Abnahmeprotokoll Ladungsträger C7100				
Benennung	Sachnummer	LT-nr	Lastenheft Indiv. Teil vom	Inhalt
SATZ BUG- /HECKVERKLEIDUNG		C7100		4
Bearbeiter	Heikki Päivö	Telefon / Fax	+358 (0)2048 49 106 / -109	

**MUSTERABNAHME**  **KONZEPT**

Vorgestellt und besprochen :

Abteilung	Name	Telefon	Datum	Unterschrift
Fertigung				
Fertigungsplanung				
Qualitätssicherung				
LT-Hersteller				
Teillieferant				
<b>Bemerkungen</b> / <b>Änderungen:</b>				

**SERIENABNAHME**

Abteilung	Name	Telefon	Datum	Unterschrift
LT-Planung	Heikki Päivö	49 106		
LT-Hersteller				
Leergut / Versand	Minna Viitikka-Herrala	49 107		
Sonstige	Ville Antola	49 206		
<b>Bemerkungen</b> / <b>Änderungen:</b>				

(Pic.108) a quality, inspection and approval form in use in Germany.

Sources: [www.tres.elblag.com.pl/eng/glowna.php](http://www.tres.elblag.com.pl/eng/glowna.php)

[www.llogistics.com.pl/en/main.xml](http://www.llogistics.com.pl/en/main.xml)

[www.elkas.de](http://www.elkas.de)

[www.piccolo-kul.de](http://www.piccolo-kul.de)

<http://josta.mx2.vnett.de>

## 9.5 General instructions on packing improvement

All material that is used in packing should be clean, dry and undamaged. If filling or cushioning material is required in the packing process it should be recyclable and/or reusable. Heavy items should always be placed on the bottom and lighter items on top. Safety measures in packing and handling are mandatory and should be enforced by continuous inspections. Standard sized cardboards and racks should be taken into use. The boxes and pallets used should be multipliable or divisible by the measurements of the inside of the container or truck. This way an optimal loading percentage is obtained. Oversized packages should be avoided as well as any parts protruding over the pallet. The pallet should be filled with boxes to the maximum potential. This should be emphasized when training the warehouse personnel. All boxes must have labels. Especially when shipping multiple boxes that are attached to the pallet by plastic sheeting. One label per pallet is not enough, if the bundle breaks and only one box is labeled, there is no way of identifying the rest of the boxes.

It is important to be able to handle the parcels safely and yet effectively. A ten (10) cm ground space is recommended to be left for the fork-lifts. It is also recommended that plastic or metal binding bands are used preferably to shrink wrapping. The wraps are much stronger than plastic wrapping they ensure a safe arrival to the customer. Another mistake that frequently takes place is that there are nails protruding from the sides of the box. The nails are commonly used when securing the part inside the box with pieces of plywood. If the nails go through the box they should be hammered down from the outside of the box or replaced completely. Protruding nails are dangerous to package handlers as well as to other boxes. If a box is shipped within Finland or domestically in other countries the weather conditions should be taken into consideration. Package should be protected from the weather even though it is not being shipped via sea-freight. The climate conditions can be humid, icy or in other ways demanding. Safety and practicality should always be a primary concern.

When shipping items that are fragile, heavy or need other special attention, all parts that have been examined in this work, directives on how to package the parts should be provided in the package itself. If the customer or MM dealer agent has to return the shipment or it is contingently shipped to a third party it is of great importance that the chain of transportation is guaranteed free of damages. If packing instructions are shipped with the part itself the next shipper will know how to ship the part safely onward. For example, Metso Minerals will provide standard packing instructions for parts that are shipped directly to an end-user or a MM dealer.

## 10 An ideas to standardize

There will be two separate ideas to standardize the packing and shipping processes, and how to introduce them to an ERP system.

### 10.1 Idea I

This idea should initially be directed to the heavy and fragile items examined in this thesis. By using four different sizes of pallets the space in the container or the truck can be optimized. The four sizes would be 80x120, 100x120, 40x60 and 160x240 all in centimeters. These are four of the most common pallets used in the EU. The pallet frames can be combined with bottom plates, spacer plates (dividers), and lids. When an item is shipped it is first measured. The next-size-up pallet should be used to make sure the part is completely on the pallet and still keep the measurements divisible with all the pallet sizes. This way the space in the trailer/container will always be filled to the maximum capacity. The use of pallets and pallet frames would practically eliminate the use of expensive sea-freight cardboard. Pallets and frames can be used over and over again (completely recyclable) giving the package material a longer life span in comparison to cardboard. Recyclable cushioning material such as PadPack, which is crushed out of recycled paper, and anti-corrosive plastic can still be used.

All parts are in the MM database. The designated shipping instructions could eventually be incorporated into the ERP system that is selected. The directives on how to ship a specific part could be under “an item group”. For example, “Bushings”, “Bronze parts” and so on. The item group would provide the database user with the weight, size and the packaging code. This information could be seen already when the customer orders the part from the Distribution Center.

The packing would still begin with measuring the diameter of the part.

All the pallets would be given a packing code number:

- |           |   |           |
|-----------|---|-----------|
| • EUR     | 1 | (80x120)  |
| • FIN     | 2 | (100x120) |
| • ½ EUR   | 3 | (40x60)   |
| • DBL EUR | 4 | (160x240) |

After the pallet number the user would indicate the number of bottom plates, dividers, pallet frames and lids used. This way the code 1,1,0,1,1 would indicate that the part is on a EUR

pallet, there is one bottom plate, no dividers and one pallet frame and a lid. The code would be indicated in the Item group; for example:

- BUSHINGS
- An item number xxxxxx is a bronze bushing. Its measurements are 50kgs, diameter is xxx cm, and it is under the packing code 1,1,0,1.

Below an example of a possible outlook of a page in the manual

There are several places that Metso Minerals could acquire shipping materials from by arranging bidding process between the materials supply companies.

Initially this list could pertain to heavy and fast moving items. Eventually the packing code could be spread out to all items shipped in Metso Minerals.

			LAVA	POHJALEVY	VÄLILEVY	KAULUS	KANSI	
LAVA			LÄHETYS	1	1	0	1	1
1=	Eu	80X120	LÄHETYS	3	1	1	2	1
2=	Fi	100X120	LÄHETYS	2	1	2	3	1
3=	_ Eu	40X60	LÄHETYS	4	1	0	1	1
4=	2XEu	1600X2400						

			PALLET	BOTTOM BOARD	SPACER BOARD	PALLET FRAMES	LID	
			SHIPMENT	1	1	0	1	1
Eu	80X120		SHIPMENT	3	1	1	2	1
Fi	100X120		SHIPMENT	2	1	2	3	1
_ Eu	40X60		SHIPMENT	4	1	0	1	1
2XEu	1600X2400							

Below is an example of item codes.

Bushings	Item #	weight in Kgs	packing code
	N123456	200	1,1,0,1,1
	N234567	50	3,1,1,2,1
	Z123456	100	2,1,2,3,1
	A456789	80	4,1,0,1,1

(Table 4) Example on packing system improvement in an ERP system.

### 10.1.1 Current directives on materials handling according to the DC Tampere

It is the purpose of these current guidelines to ensure a seamless continuum of the material- and information flow in the Tampere area DC unit for wear and spare part deliveries.

This directive is to be applied to all the DC Tampere units spare and wear part deliveries.

Directives for the shipping and packing department:

All the orders are attempted to be packed according to the timeframe agreed upon and the picking of the items is inspected as well as possible so that it matches the picking order list.



While packing the parts it is imperative to take into consideration the method of transportation for the part in question. There are several weight and size limitations in courier shipments. The packaging staff must be aware of all these limitations. Since the limitations and tariffs vary rigorously according to the service provider and the destination country, it is impossible to maintain standard rules to be applied to. All the limitations must be appreciated when packing. In sea-freight, a plywood box or a sea-freight carton is to be used. All the boxes, plywood or sea-freight cartons, are to be wrapped in plastic sheeting.

Pallets must be sturdy and durable. When filling up a pallet, one must always take into consideration that the unit must be able to be handled as safely as possible all the way to the final destination.

When shipping pallets, it must be well ensured that the receiving country does not have any restrictions in the wood-handling procedures.

All electronic parts are to be covered with an anti-corrosive material and if necessary wrapped in plastic. The part must be supported enough so that it will not move or shift during transportation.

When shipping via air or courier transportation normal cardboard or plywood boxes are to be used. Again, the parts must be secured in the parcels so that they cannot move during transportation.

After packing, the picking list must be marked with the following notations:

- The size of the container in centimeters; length x width x height
- The entire weight to the nearest kg and the type of the container according to the following list:
  - Cardboard =CrdBrd
  - Plywood box = PLWd
  - Parcel =Pckg
  - Pallet
  - Pouch
  - Container
  - Bunch

In case the parts do not fit into one single container, it is to be marked numerically on to the picking list as to which part is in which container.

The following markings must appear in the container:

- The destination of the shipment with the correct abbreviation (for example US) or the entire name of the destination country must be written in its entirety.
- The picking number (for example SFI12345)

- If multiple containers are shipped, the containers must be numbered such as 1/3, 2/3, and 3/3.

The finished container is then moved to the place reserved to the shipments leaving for the particular country and to a waiting area specifically marked. The picking list is then delivered to the shipping office, where the lists are then attached to the containers that are departing. The containers that are leaving the warehouse are reported and indicated to the fork-lift operator who will then, in turn, load the out-bound merchandise to the truck.

### **10.1.2 Current shipping instructions for suppliers and subcontractors, DC Tampere**

The instructions pamphlet is directed solely to the companies that supply materials and/or parts to Metso Minerals (Tampere) Oy. The instructions reinforce the supply clauses already in use for suppliers and subcontractors agreements. The incoterms clauses that normally are used are FCA (free carrier – named place) or DDU (delivery duty unpaid).

No P.O. Box addresses are to be used in any shipping documents on either the shipper's or the receiver's address information. Also the delivery address must be clearly separated from the billing address.

The delivery date marked on the order must be honored. All separate parcels are to be marked with identification stickers or in other suitable way. The markings must indicate the Metso order number, the order position and the Metso item sign. In case there are several separate items on one order, all the items must be marked in the way described above. If a part consists of several separate items they all need to be sent in the same shipment.

Items for separate production units cannot be combined in one package or on one waybill. If several parts are shipped in the same shipment to the same production unit, the orders must be clearly itemized on the waybill and on the same packing list. The parcel must also contain the order number and part identification number.

If several parcels are shipped, all the packages must contain an individual address label and a packing list. If there are several packages on the same pallet, each of the parcels must contain an individual packing list of the items on that particular pallet. Also, on each address label a complete number of pallets shipped must be indicated.

Styrofoam or other air-filled plastic cushioning are not to be used since recyclable materials are recommended.

Standard sizes of boxes are recommended to be used. In Metso Minerals the standards are normally 40\*60cm, 20\*30cm and their multiples and divisible. Oversized packages are to be avoided.

Standard sized pallet as are also to be used. Metso Minerals uses only EUR pallet (80\*120cm) or ½ EUR pallets (80\*60cm). In case these pallets make it difficult to ship due to the size or the weight of the part, special pallets can be used taking into consideration the 10cm minimum that the pallet requires to be able to be handled with a fork-lift. FIN pallets, over-size pallets or pallets that are larger than the part itself should be avoided.

If the shipper is paying for the cargo, the method of transportation can be chosen by the shipper itself. (Metso Minerals) If the weight of the cargo is less than 30 Kgs the primary method of transportation is the haulage service of the post office – Itella. The post office always requires the customer identification number of Metso and the order number on the package. If the weight of the parcel is over 30 Kgs, the current haulage partner is to be chosen.

## **10.2 An idea II**

This idea should initially be directed to the heavy and fragile items examined in this thesis. By using four different sizes of pallets instead of the two that are now the standard, the space in the container or the truck could be optimized in a much more efficient way. The four sizes would be 80x120, 100x120, 40x60 and 160x240 all in centimeters. These are four of the most common pallets used in the EU. The pallet frames can be combined with bottom plates, spacer plates (dividers), and lids. When an item is shipped it is first measured. The next-size-up pallet should be used to make sure the part is completely on the pallet and still keep the measurements divisible with all the pallet sizes. This way the space in the trailer/container will always be filled to the maximum capacity. The use of pallets and pallet frames would practically eliminate the use of expensive sea-freight cardboard. Pallets and frames can be used over and over again (completely recyclable) giving the package material a longer life span in comparison to cardboard. Recyclable cushioning material such as PadPack, which is crushed out of recycled paper, and anti-corrosive plastic can still be used.

All parts are in the MM database. The designated shipping instructions could eventually be incorporated into the ERP system that is selected. The directives on how to ship a specific

part could be under “an item group”. For example, “Bushings”, “Bronze parts” and so on. The item group would provide the database user with the weight, size and the packaging code. This information could be seen already when the customer orders the part from the Distribution Center.

The packing would still begin with measuring the diameter of the part. All the pallets would be given a packing code number:

- EUR                                   1                                   (80x120)
- FIN                                   2                                   (100x120)
- ½ EUR                               3                                   (40x60)
- DBL EUR                           4                                   (160x240)

After the pallet number the user would indicate the number of bottom plates, dividers, pallet frames and lids used. This way the code 1,1,0,1,1 would indicate that the part is on a EUR pallet, there is one bottom plate, no dividers and one pallet frame and a lid. The code would be indicated in the Item group; for example:

- BUSHINGS
- An item number xxxxxx is a bronze bushing. Its measurements are 50kgs, diameter is xxx cm, and it is under the packing code 1,1,0,1.

### 10.2.1 Example of a possible outlook of a page in the manual

	PALLET	BOTTOM PLATE	DIVIDOR PLATE	PALLTE FRAME	LID
SHIPMENT	1	1	0	1	1
SHIPMENT	3	1	1	2	1
SHIPMENT	2	1	2	3	1
SHIPMENT	4	1	0	1	1

PALLET	SIZE
1=Eu	80*120
2=Fi	100*120
3=½ Eu	40*60
4=2*Eu	160*240

Bushings		
Item #	Weight in kgs	Packing code
N123456	200	1,1,0,1,1
N234567	50	3,1,1,2,1
Z123456	100	2,1,2,3,1
A456789	80	4,1,0,1,1

(Table 5) Second example of an improvement idea for an ERP system

As far as shipping materials go, there are several places that Metso Minerals could acquire them by arranging bidding between the materials supply companies.

Initially this list could pertain to heavy and fast moving items. Eventually the packing code could be spread out to all items shipped in Metso Minerals.

Examples of the using the coding method described above, is shown on the following pages.



(Pic.108) *example of a pallet, pallet frames and lid. The code of this package (providing there is no divider plate inside) would be: 2,1,0,2,1.*

*2=FIN pallet, 1=one bottom plate, 0=no divider plate, 2=two pallet frames, 1=lid.*



(Pic.109) *1,1,0,1,1= Euro pallet is used, one bottom plate, no divider plate, one pallet frame and one lid.*



(Pic.110) 3,1,2,3,1

*A ½ EUR pallet is used, one bottom plate, two divider plates, three pallet frames and one lid.*



(Pic.111) *pallet frames can be used as many as necessary on one shipment. This parcel's code would be 2,1,2,5,1= Fin pallet, one bottom plate, two divider plates, five pallet frames and a lid.*

### **10.3 Positives of the standardization**

A unified way to pack all items would eventually exist in Metso Minerals all over the world. The trailers and containers would be used to their capacity reducing the filling percentage possibly down to 40% from 80% fill rate, thus cutting the shipping costs in half. The packing would be accurate and fast when everyone would automatically know how to pack each item that leaves the warehouse. The customer satisfaction rates would increase. There would be fewer damages caused by shipping due to durable and standard sizes of the packages. By using the pallet frames and dividers with lids and bottom plates would provide a completely recyclable, environmentally safe way of packing since all the packaging materials are reusable. This would also enhance the company's image.

Storing the packing materials would be easier since the frames are foldable and take less space in the warehouse. The contractors and suppliers would be provided with Metso Minerals' packing materials. As the parts arrive to Metso Minerals, they could be stored on shelves in the original packaging, ready for further shipping.

By far the best result of packing the way previously indicated would be the increased capacity of the fill rate. If MM currently uses 80% of a trailer's floor surface due to items that cannot be stacked on top of each other. By using the pallet frames and lids, all the parts could be stacked and the space would increase in height but decrease in length. Since the companies only pay for the space they use up in a trailer, this method of packing would significantly reduce the cost.

A demonstration of the fill rates in a trailer is shown on the following page. The picture shows that if the packages could be loaded on top of each other the fill rate would be reduced and the cost of shipping would decrease.

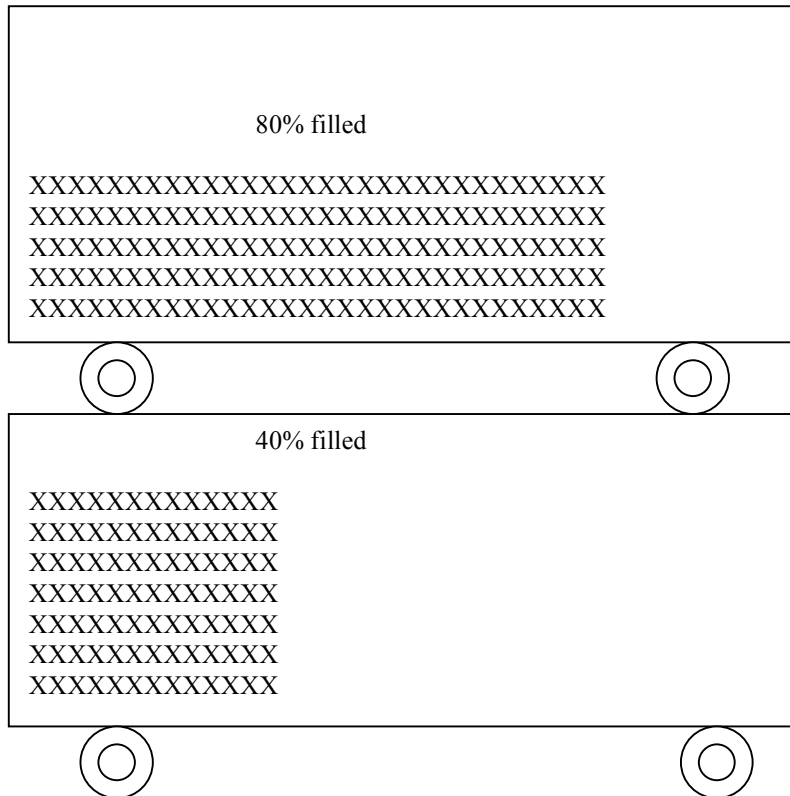

(Pic.112) Stowage percentage (fill-rate) illustrated above.

#### 10.4 Possible problems with standardization

All the wood used in the pallets, dividers, bottom plates and pallet frames cannot be shipped to all the countries. The IPPC (International Plant Protections Conventions) requires that all wood used in shipping is fumigated and heated to a certain high mandated temperature. This is to eliminate the living organisms and underlying insects from spreading globally. For example, the wood used to ship from i.e. China might not meet the standards required by the receiving country.

Initial investment would require funding that should be incorporated into the shipping budget. The supplies and material acquisitions would swallow a large portion of the budget itself. However, this would only be a one time investment and the return on investment would be significantly big. Also providing all the suppliers, dealers, all MM warehouses and even end customers with the correct material to ship and return parts would require money but including a manual with the shipping materials giving step-by-step instructions on how to pack the part for shipping would eventually save the company more.



The problem to get everyone to follow instructions and mandates has already proven tricky. The warehouse and shipping staff should all be emphasized on how important this project would be. Additionally even though the suppliers and other parties who would be supplied with the new shipping materials would benefit from it, so would Metso Minerals. MM would still own all the shipping supplies.

## **11 The shipping manual**

The manual would initially be directed to the centralized warehouse in Belgium (the LEP – Logistics European Project). However, the manual should be in such a way that it could be translated into a few common languages such as Spanish and French for example. The manual should function as a guide and a reference to all employees involved with shipping, packing, receiving and parts identification. The handbook should provide very simple instructions and provide easy information and examples with the combination of pictures and written text. The content should focus mainly on packing and handling heavy and odd-shaped parts and packages that may require special handling. The use of RFID (Radio Frequency Identification) tags or transponders could be taught. It is an excellent way to identify a package because one part of the tag contains information on the product and the other part of the tag acts as a transmitter of the signal which enables the tracking of the parcel it is attached on. The RFID system could also be used in inventory-tracking and -management as is already done in major supply chain management circuits. To further this idea, having the suppliers use the RFID technology already in the beginning of the supply chain would remarkably better the identification process. If the manufacturers would be able to use the MM packaging materials and at this point of the process attach the RFID tag to the packages, when the part arrives to Metso Minerals it could be hauled to storage unopened and kept there for further shipping to the customer. This process could eliminate all the unnecessary opening of the packages, removal of the manufacturer's own markings/stickers and no repackaging would be needed saving time, labor, labor costs and shear money.

Labels, such as waybills, shipping- and address-labels and bills of lading should also be included in the manual. A timely and costly training process could practically be eliminated if the manual addressed all necessary information needed in the shipping process.

Pictures tell a thousand words. Step-by-step pictures on the manual could be used as examples on how to pack the part in question safely for the particular method of transportation used. Each example would also contain suggestions and variations on materials needed.

In-bound items to warehouses (parts that arrive to Metso Minerals warehouse from an outside supplier) would be dealt concisely to ascertain an optimum storage cycle and shelf life. This process would also provide valuable benefits to the inventory control department and to the receiving end-user.

The manual should primarily be directed to Metso Minerals' personnel, suppliers, dealers, any external warehouse locations but would also offer extreme value to the transportation service partners such as DHL, Transworld, Schenker and numerous others.

Warehouse staff has already been supplied with a set of posters to enhance the moral of the work environment and to motivate the shipping personnel.

## When dispatching an order to a customer, always check the following

- 1 Do all items correspond to the picking list?
- 2 Are all items marked with a Metso part number?
- 3 Do all items meet the quality standard?
- 4 Have the parts been packed according to the chosen transport method and is that method correct?
- 5 Is the package according to the safety regulations and are the handling instructions adequate?
- 6 Does timber packing comply with the recipient country's regulations and are all certificates included?
- 7 Does the dispatch note comply with the freight note and are all other documents in order?
- 8 Are the delivery address and delivery date correct and all contact details clearly visible?
- 9 Is the delivery term correct and in accordance with the agreement?
- 10 Have all dispatch details been updated in the system?



(Pic.113) A check list on a MM warehouse poster.

### 11.1 An alternative improvement method investigated

Another idea worth looking into would be to have the manual structured so that all the parts examined would be listed on an index. The parts would be categorized in a separate column and the method of shipment on other columns as shown below:

<b>PARTS</b>	<b>SEA FREIGHT</b>	<b>AIR FREIGHT</b>	<b>COURIER</b>
Bronze	pg. # x	pg. # x	pg. # x
Electronic	pg. # x	pg. # x	pg. # x
Filters	pg. # x	pg. # x	pg. # x
Axles	pg. # x	pg. # x	pg. # x

(Table 6) *Example of a possible ERP system page.*

The parts would be listed on one column and depending on the method of transportation the instructions would then be explained on a corresponding page. To take this idea a little further all the parts could be put under an item group. Also all the shipping materials would be under a code. For example under an item group called “Bushings”, all the bronze parts and bushings would be listed according to the item number, weight and a packing code.

This would enable some enormous changes in the future of shipping, such as when the customer calls to the DC to order a part, the sales person would automatically be able to give the customer the size and the price directly over the phone and more importantly over just one phone call. This would be a revolutionary improvement in the Metso Minerals pricing procedure.

All in all in the process of making the manual it would be most important to keep the bigger picture in perspective rather than concentrating on a single warehouse. The research for the shipping manual was begun from the Tampere, Finland warehouse but obviously in the future it should be able to be applied to all warehouse locations situated globally. The manual should then be distributed to all DCs, LSUs (Local Sales Units), and dealers. It would contain a wider variety of items which would be placed under larger item groups. The ultimate goal would eventually to have all items in a shipping category /item group. At the point of piloting the new packing method (in Tampere) would only concern heavier and other critical items.

Concerning not only the stowage percentage that would possibly improve the cost –efficiency the goal of this synchronized packing procedure would also to reduce the packing time and labor costs. It would also reform the packages so that they would become divisible with the

container and the other pallets. In other words, MM would not ship a package that is measured for.ex. 0.7m in width but a package that is either 2,4m, 1.2m, 0.8m or 0.6meters including the pallet in the measure. This way Metso Minerals would be globally producing packages that are divisible with the trailer sizes. In practice this means that packages are completely lashable in the trailer. It is cost-efficient to pay for the extra room for the pallet even if it slightly larger than the part itself.

## 12 Outsourcing the packing process

An outsourcing seminar was held in Kalmar Industries in May of 2006. The question was what to outsource, why, when, why not? The seminar was arranged by TBC – Tampere Business Campus and was extremely valuable in learning about the good, bad and the ugly matters of outsourcing.

Kalmar Industries manufactures freight containers, trailers and provides hard manufacturing services a.k.a. heavy machinery for conveying and transferring goods. In 1999 Kalmar Oy adopted a strategic thinking of “One cannot concentrate on everything”. The company started to outsource services and gain collaboration partners. The point behind this way of thinking was to “keep the financial worries out of the picture”. In other words Kalmar Ind. is following a downstream strategy, where procurement is the upstream and sales is the downstream.

Kalmar Ind. believes in having an “open-door” policy with its partners in trade. Companies can come and see for themselves how things are done in Kalmar. The company also wants to make it easy for the employees to come and talk to management whenever they feel a need to. (Open door policy)

Even though Kalmar Ind. has outsourced all other than their core product, they want to keep the company as similar as it has been before the outsourcing started to take place. It is vital to them that employees are not let go due to outsourcing procedures. The remaining work agreements are also continued. This also means that the wages of the employees are not decreased. The HR department will explain the reasons and arguments behind outsourcing to the personnel. This explanation includes the rights and social consequences to the employees as well as any possible negotiations that will take place. This release of information to the personnel, though, must be *immediate*.

After participation the packaging seminar in Kalmar Ind., I was able to obtain valuable information of outsourcing of the entire packaging process. Kalmar Ind. has outsourced packing to an outside company. In outsourcing all the fixed expenses turn into movable

expenses. It must be determined what sort of instruments will be used, i.e. leasing, paying for something for an additional six months for example, or a contract will be valid for a minimum of x-amount of months. Rent or service agreements hold a lot of legalities about responsibilities and so on. When a company has decided to outsource anything or when buying or selling services it is good to have a checklist on all items that need concern. The checklist then enables the responsibilities to be determined beforehand. When outsourcing, questions such as what will be outsourced – in this case it would be packing and shipping the wear and spare parts. Outsourcing, in the end, means giving up something like a process of a company. Question of what will be gained from outsourcing must also be examined carefully. What will replace the previous function? How and when will this change take place and how will the employees be compensated or taken care of due to the outsourcing process? If the company does decide to outsource it is imperative that the employees are notified immediately when any changes that involve them directly will occur. Fast notification creates a credible work environment. Trust and credibility in the work place create a competitive company this in turn reflects the reputation of the entire operation in the outside markets.

Kalmar Ind. has consolidated their inventory into three warehouses. One is in Sweden, one in Central Europe and one in Finland. ValLog takes care of all of Kalmar's warehousing and packing needs in Tampere (outsourced).

Kalmar Ind. uses a special strategy when collaborating with new and existing partners. The following figure is a model from Sandvik and is full use in Kalmar Industries.

## **12.1 How does outsourcing work?**

The release contracts of the business and the service contracts of the business. Both of the contracts must have the following terms and include the guidelines of other conditions negotiated.

### **12.1.1 Questions that must be asked when outsourcing**

- What has been bought/what has been sold?
- How will this process be organized?
- The time frame of the buying and selling must be agreed upon.
- Price
- What are the effects on the employees?

- What is the over-all effect on the company as a whole?

### 12.1.2 Sandvik's strategic partnering idea

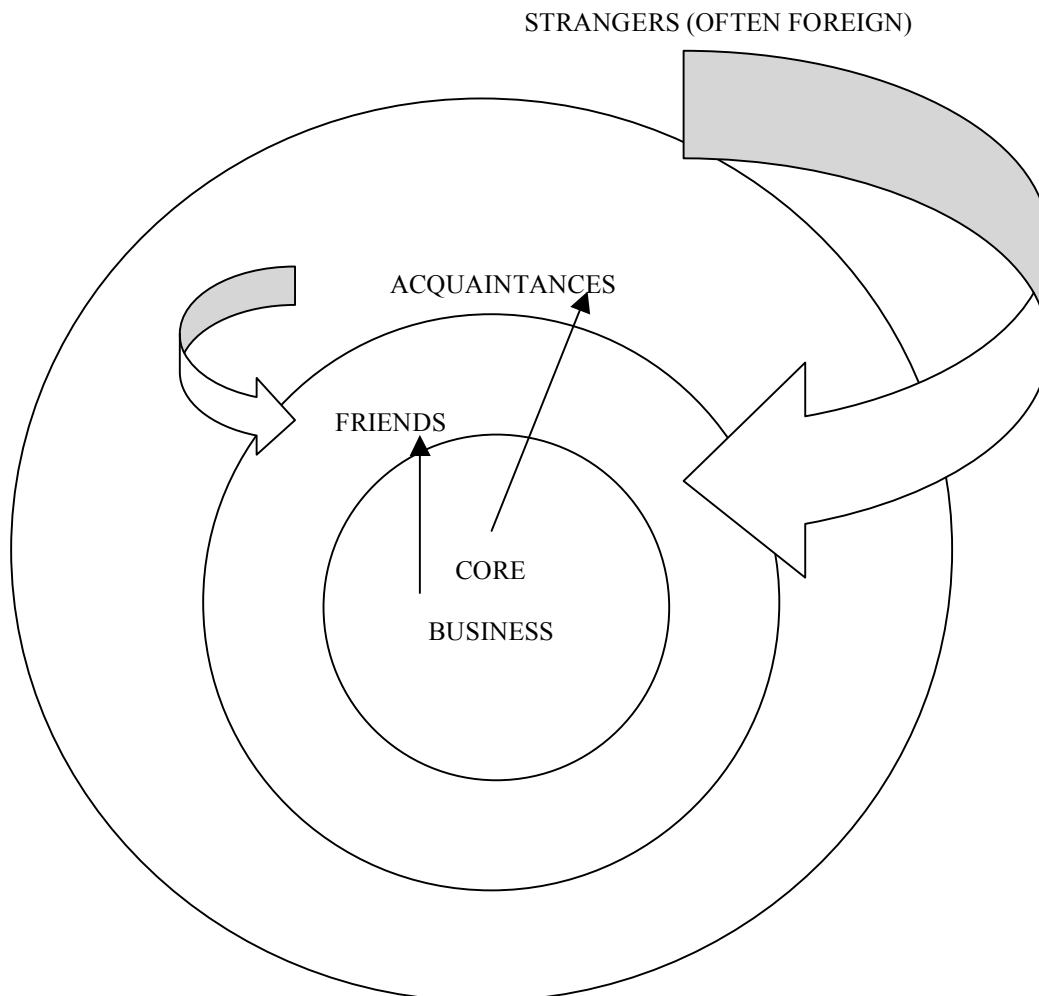

(Table 7) *The Core Business purchases from friends and acquaintances. Acquaintances and Strangers buy from Friends.*

Integration of departments can prevent outsourcing. In Kalmar Ind. the receptionists, the phone-center employees and the security gate employees have been consolidated. There everyone knows how to do each others' work. This way everyone has something to do at all times and the employees input is this way optimized.

## **13 LEP – Logistics European Project**

Logistics European Project was started in order to obtain a warehouse in Central Europe and outsource the warehouse staff. The location selected is situated in a so called “Blue Banana” area where the transportation possibilities are nearly optimal. It is close to several large harbors and ports, it has well functioning rail transportation possibilities and the short road transportation time can shorten the delivery time to the customer significantly. Metso Minerals is currently also looking to get a same day air transportation service to enhance the delivery times, the order logs and the back logs.

### **13.1 Trends and dynamics in SCM**

Trends and dynamics in a global supply chain management are changing. Global production and sourcing, for example, in the Far East is increasing rapidly. There is a stronger separation of the primary (plan-based) and secondary (order-driven) production functions. Plants are increasingly becoming specialized in certain products, making them more focus oriented plants. European markets are strongly attempting to penetrate and expand the markets in the Far East, especially China. Supply chain management is starting to have an increased interest in capacity flexibility over time. There is also a growing use of integrator services such as overnight deliveries.

Overall the current trend is moving towards more regionalized solutions with central locations. This is due to a growing congestion (bottlenecks) and a relatively high transportations cost in the European area.

This seems to be the main reason for a company (such as Metso Minerals) to localize a central warehouse with easy accessibility to road transportation, harbors, airports and rail transport possibilities.

(Supply Chain mgmt and advanced planning – Concepts, Models, Software and case studies by Hartmunt Stadtler and Christoph Kilger 3<sup>rd</sup> edition, 2005 Springer)

## **13.2 The transportation concept for LEP**

The transportation concept for LEP is to have a centralized location first in Europe and then expand the global reach to other continents, especially the fastest developing country; China. The concept is to be able to reach any customer anywhere in the world as fast as possible.

### **13.2.1 The current situation in transportation**

Metso Minerals' current transportation structure in Europe is based on weekly ground transport, air shipments and the use of courier services. There are only 1 to 2 shipments to most countries from several DC's in Europe. This is mostly due to high transportation costs and time restrictions. Single-consignment deliveries, weighing less than 2500 kgs and direct shipments, weighing over 2500kgs (part loads) are called groupage goods. Depending on the customer's urgency, the parts outside Europe are shipped via air- and ocean carriers. Outside Europe couriers are seldom used unless there is an extreme urgency (i.e. a breakdown) with a customer. The journey of the shipment starts from the DC from where it is hauled by a truck either to the closest port or directly to a main harbor. If the closest port is not a major harbor, such as Antwerp, Rotterdam or Hamburg, the freight is transported there via a feeder vessel and then re-loaded to an ocean carrier.

### **13.2.2 The objective for future transportation in LEP**

The main objective of the LEP concept regarding transportation is to decrease logistics costs, avoid unnecessary inter-facility transportations (parts are constantly being shipped from one MM warehouse location to another or to a third party (LSU) so that they can then deliver it to the customer. This is another major inventory control problem in Metso Minerals) and to reduce the delivery-time of the products all the way from the inventory to the end user.

This change in the MM logistics processes makes the transportation more efficient. It will be vastly more feasible to be able to consolidate most of the in-bound and out-bound transportations into bulk shipments. These bulk shipments can then be delivered directly to the customer instead of using material routing processes between Metso Minerals' warehouses and Local Sales Units (LSU's). The new logistics project will also improve immensely the Metso Minerals' ability to support the customer from one or two locations instead of dozens. This is also vital as the cooperation with the dealer agents will begin to improve and change. The dealers will eventually carry more and more inventory.



### 13.2.3 The future structure of transportation for LEP

As the project progresses, the material flow will be altered so that some of the countries will no longer carry local inventory. The transportation concept will change so that the products will be delivered to the end customer straight from the new centralized warehouse or in urgent cases directly from the actual supplier of the products. This will eliminate many middle-men and the transportation time will shorten significantly. The countries that are left holding local inventory parts can be shipped either from the warehouse (DC) or a local LSU as usual, or if need be, from the central warehouse. From where the parts are shipped will be determined by what ever shipping location is closest to the customer. This way the customer is provided with the fastest and the most cost-effective deliveries at all times. Once a global shipping manual is provided to all the locations that hold inventory, to the new central warehouse, to LSUs and even to the suppliers, damages will be reduced considerably. All this combined will increase customer satisfaction in both delivery times and accuracy but also due to less damages hence less waiting time for replenishing the damaged parts. The transportation changes will be implemented in phases. The Local Sales Units' abilities to transport will be examined and optimized, and in the end, the right part is delivered, on the right time to the right location.

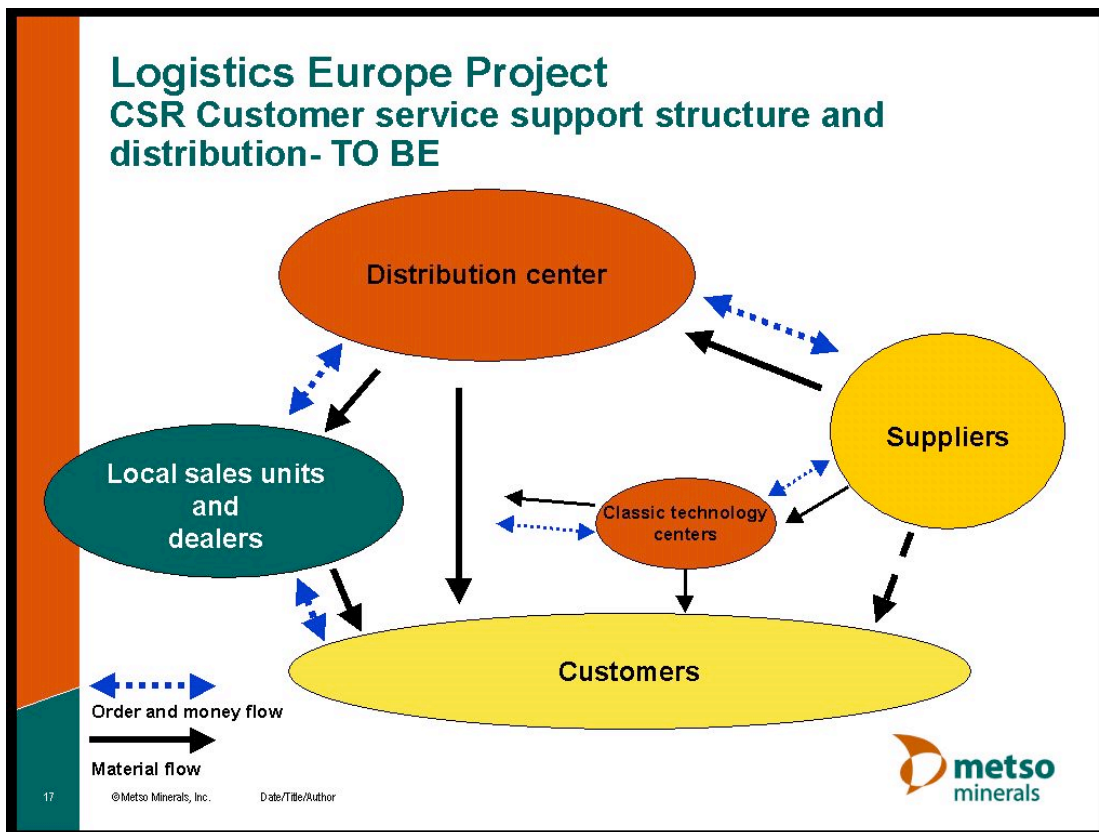

(Table.8) *the new distribution-chain model, after implementing a new central warehouse, shows the material-, order- and monetary-flows.*

### **13.2.4 The road transportation after implementing Logistics Europe Project**

The basic idea for the road transportation in the LEP transportation concept is to create regular and dynamic deliveries to agreed countries, based on the location of customers in different areas of Europe. The decision on the number of deliveries will be based on volume forecasts. All the details such as delivery days and –times will be made with the transportation partners. The schedule will be completely built up according to customer demands. The goal is to reach a 100% customer satisfaction. In case of any problems, there will be an agreed number of trucks “on-call” in the central warehouse. The trucks will be able to respond quickly and operate efficiently during an emergency or a breakdown case.

### **13.2.5 Stock replenishment and wear parts for the LEP**

The stocks will be replenished according to an agreed process through road transportation. The LSUs and the dealers will play a major role in maintaining the transportation costs and keeping them in an acceptable level. In reality, this means that the LSUs will need to have frequent and active contact with the customers, and to have the ability to supply the customers with the correct parts in reasonable sets for stock replenishments in order to avoid breakdown deliveries. A parts list containing a vital and regular inventory is recommended to be kept. The lists must contain parts that vital to the customers, fast moving items and parts that generally need to be in stock at all times. The role of the parts list becomes even more important in supporting the LSUs and the dealers because if the list has too many parts on it, the inventory costs go up. If the list has too few parts on it, there won't be enough inventories to sell. The list should also *not* contain any parts that the customers, for one reason or another, does not want to keep in their inventories.

In addition to the above, active participation by the LSUs and the dealers will help to build a growing and superior network of deliveries and an enhanced transportation system. This can eventually help build a transportation system so efficient and organized, that responding to emergencies and breakdown situations can be handled as normal road transportations. To be able to handle deliveries for breakdown emergencies as regular road transportations, would create large savings for the customers (road transportation vs. a courier) and would be a major factor in customer service.

### **13.2.6 Emergencies and breakdowns (ground transportation) during LEP**

The object is to be able to eventually deliver parts also for breakdown emergencies via road transportation that is regularly replenishing the stocks. This can only be done as long as it meets the customer's demand, schedule and need. To be able to implement this, the entire Europe will be divided into time-zones for normal road transportation. This will be done together with the help of the transportation partners. After this, every customer location will have its own time-zone, for example, "Area reached in 12 hours" or "Area reached in 24 hours" and so on. However, eventually the decision of what transportation method is used, is made according to the absolute customer need and the time-zone. If it is determined that the road transportation will not get the crucial part to the customer's location on time, air-shipment or a courier will be used.

### **13.2.7 Air and Ocean transportation for the LEP plan**

The current situation in the air and ocean transportation systems will be studied and according to the results a decision is made whether they meet with Metso Minerals' standards. As the project proceeds all the transportation partners will have to work together seamlessly. The LEP plan is introduced to the transportation partners and will be discussed. Maintaining only two global transportation partners, would most likely support the LEP transportation concept in the most effective way.

Also cost-effectiveness will be improved by comparing and competing different pricing options and having, for example one air and ocean service provider to make inland pick-ups. Air and ocean transportation services consist of several cost elements such as cargo handling and documentation, inland pick-ups, export clearances, terminal fees and harbor dues. Currently only one service provider is used. By making some minor changes in the delivery processes several different service providers can be used instead of only one. In making these changes there are some extra work that needs to be done which can create extra cost. These labor costs need to be examined, calculated and studied so that there won't be a need for too many new resources. Optimal solution would contain a reasonable cost while still maintaining effectiveness and functional processes.

The established road transportation network will be used in transporting the shipments from the Distribution Center inventory locations to the main harbors and airports. This enables the trailers to be utilized to their optimal capacity and savings can be gained.

### **13.2.8 Emergencies and breakdowns (air transportation) for LEP**

The chosen partner for the air transportation will be expected to provide solutions and options to emergency and breakdown situations. Obviously these matters will be discussed in depth with the air transportation partner. The solutions pertain to delivery times, costs, possible weight limits etc. All special air transportation services and the solutions they can provide need to be known and that information should be easily accessible.

### **13.2.9 Courier transportation plans for LEP**

Metso currently uses couriers to deliver urgent items globally. These transportation partners are UPS, DHL and TNT. All of these existing couriers will be continued to be used in the Distribution Center transportation system. There is also a possibility of using a same-day and next-day service provider to the Nordic countries in the future.

All the prices are negotiated and agreed upon separately in every DC and are usually based in 3P pricing because the warehouse usually operates in a different country than the invoice is handled in. Establishing a centralized warehouse (in Belgium) is still more cost effective than in Finland or France, for example.

All the current couriers will most likely be necessary to be kept as partners since all of them are good in a certain area of the world. For example only UPS functions well domestically in the U.S.A. but will only ship parcels weighing less than 70kgs. There are also smaller, localized partners in Central Europe that are well worth looking into for courier services due to their good and cost-effective service. Metso expects the contracting partners to deliver services equal to their demands, if the expectations are not met, other options can be considered. Also if the partners selected to provide the road transportation services can provide similar express services to the couriers', the road transportation partners will be used. It is easier to the operational process to use fewer partners, so consolidation of services is valued and opted for.

### **13.3 Transportation partners for the LEP**

Metso's requirements for transportation partners' services are:

- Reliability
- Flexibility
- Ability to provide statistics and follow-up for performance measure purposes
- 24 hour service with a key account manager
- Freight calculator for direct shipments
- Commitment and willingness to create solutions and develop the service
- Tailored invoicing according to Metso's policy
- To have a back-up plan in case the system fails
- That the partner has an existing network of transportation (experience)

If a large company cannot provide the flexibility, reliability and the willingness to participate to develop a transportation system of this magnitude, other –different sized companies will be examined. It is quite clear that a single partner cannot provide the required services at a reasonable price therefore it is considered that approximately two to three different partners will be needed in order to achieve a fully functional yet cost-effective transportation system.

### **13.4 Possible Packing and Shipping problems in LEP**

As mentioned in the improvement and standardization sections, changing the packaging methods especially to the usage of pallets and frames (bottom plates, spacer plates and lids) can save approximately 30 – 50% of transportation costs (Termoline Sept. 26<sup>th</sup>, 2006). By using the pallets and pallet frames the parcels can be loaded on top of each other this way saving space in the truck. The use of pallet frames and lids also makes the pallet easier to handle, they save space in the warehouse and protects the parts through the entire logistic chain. Another clear benefit in using pallet frames and lids (instead of cardboard or plywood) is seen when securing the load in the trailer (lashing). Lashing will no longer cause damages to the parts because now the pallets and frames (parcels) are lashed instead of the parts as earlier. The lines and straps are now on and around the package instead of the actual part. Standard pallet sizes (EUR pallet) and its multiples will be used as a guideline. Although the benefits are clear, the management of packing materials (returns or included in the shipping price) should be studied carefully. The entire logistic chain must be considered when evaluating the logistics costs. Even though the procurement of pallet frames and other standardized packing materials will at first cause an increase in packing costs, they will save a

great deal of money in the transportation. In the long run the total transportation cost will decrease. The acquired material would have an approximately one year ROI if not shorter.

*(This estimation was a result of a meeting with the Logistics Manager Heikki Kivijärvi in 2007)*

### **13.5 Why a centralized warehouse? (LEP-project)**

Metso Minerals would reap numerous benefits from a centralized warehouse in the Central Europe area. Some of these would include some new and innovative logistics solutions and concepts. It would also expand Metso Minerals' experience in various market sectors. The transportation network of Europe would be available for Metso Minerals' use. The warehouse would be centrally located in the consumer markets. The labor force would be capable and Metso Minerals would achieve a multi-modal connectivity.

### **13.6 Key location factors for LC's – Logistic Centers in LEP**

There are some key factors, about the location that Metso has to take into consideration when implementing a new, fully functioning, centralized Logistics Center in the Central Europe. Metso should know all location factors and have as much information about the location as the implementation phases of the project begin. Metso is not only centralizing a warehouse and making it a working Logistics Center, but also outsourcing an enormous part of their transportations operations. The key location factors that should be taken into account can be identified based on the following trends and dynamics.

- **Global Sourcing**  
The centralized warehouse, in this case in Belgium has a strategic position between large container ports, intercontinental cargo airports and integrator hubs.
- **Major Consumer Markets**  
Belgium is extremely centrally located with easy access to Metso consumers.
- **Postponed Customization**  
The Logistics Centers are complete, turnkey solutions. The warehouse can be made to be fully functional with the combination of know how on logistics and assembly.
- **Outsourcing**  
Integrated logistics and assembly solutions are available through a knowledgeable third party staff. In this aspect the shipping manual comes into play. The outsourced employees need standardized instructions on how to ship the parts.
- **Flexible Serviced Providers**

The selected service providers will provide flexible capacity located in the center of the European markets as well as in the more remote markets (i.e. China)

- Access to Multi-Modal Transport Solutions

The center is located so that it will have and provide access to rail-, barge-, road- and air infrastructure.

- Labor Force

Again (see outsourcing) there will be a work force that will be skilled, motivated and flexible who can be trained to follow the requirements of Metso Minerals, especially regarding packing, shipping, storing and receiving parcels.

### 13.6.1 Why Belgium?

Belgium is in the central of all major European consumer markets. It ranks as the number one location of logistics centers due to its strategic position from where all major cities, harbors and integrator hubs can be reached within 48 hours of transit time. Belgium is also an attractive place to implement a centralized logistics center due to a vast number of available places and multi lingual labor reserves. Many of the world's largest brands have already a placed a central logistics center in Belgium. Some of these include Harley Davidson, Ford Motors, Toyota, Nike, JVC, Mazda, Black&Decker and Bose.

It is also possible to build a complete supply chain solution to the centralized warehouse location.

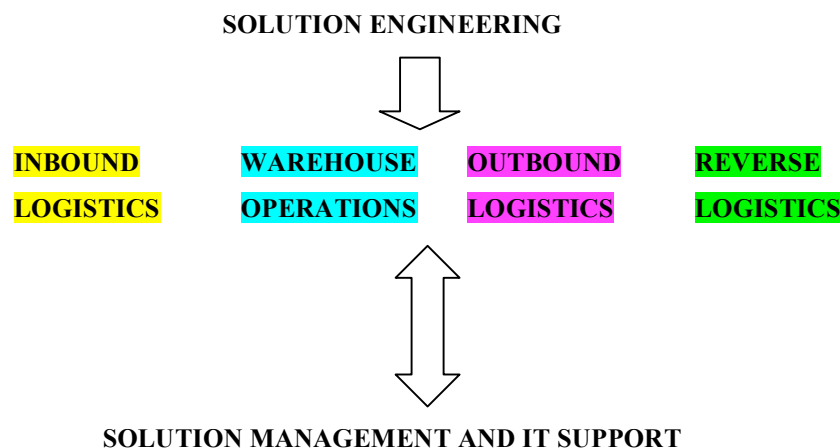

(Table.9) *Visual function of the LEP supply chain flow.*

## 14 Packing materials

Metso Minerals currently uses mostly recyclable and re-usable packing materials. The packing is mainly done by using sea-freight carton, which is thick and durable cardboard, but is very seldom used a second or a third time. Wooden pallets are obviously used in every shipment in order for the shipment to be able to be handled with a forklift. Iron-enforced plywood boxes are used in excess considering the option on using pallet frames and lids. For cushioning materials Metso Minerals has been paying special attention and most of the materials used today are, in fact recyclable. Anti-corrosive plastic and moisture repellent, regular heavy duty shipping plastic is also regularly used in shipments. The rust-preventing plastic has very few, or no alternatives so it will most likely remain in shipping. However, not all plywood boxes need to be wrapped in regular shipping plastic after the box is fastened with nails and metal wraps.

Small cardboard boxes are used for courier shipments, such as for UPS and other shipments for small items.

Heat treated wood is used inside the plywood boxes to secure the parts inside the parcels. Other wood and metal alloys are also a part of the current shipping process.



(Pic.114) *recyclable paper is most often used in replacement of bubble wrap. The crushed paper (such as PadPack in Tampere) is a good alternative and can be used multiple times in re-shipping.*

### 14.1 Measurements of parcels

The method of calculating the dimensional weight of a parcel is important. This (cubic size determines how much of room will the parcel take in a trailer or a container. The dimensional weight and its multiples become even more important when shipping via courier service. For



example UPS is extremely strict about their standards of the “cubic weight” as is the term they use for it. A good advise is to measure the length, with and height of a parcel and multiply them together. This calculation will provide you with the cubic weight of the package.

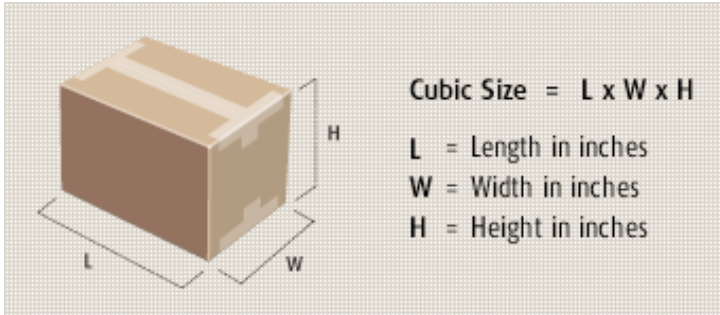

(Pic.115) picture shows how to calculate the cubic size of a box.

Airlines are known to be extremely precise on the measurements and the cubic sizes of a parcel. Therefore it is in everyone’s best interest to do research on the size the courier allows to be shipped and then to make sure that the requirements are followed.

## 14.2 Alternative packing materials

(Pic 115)“Only the day that you find yourself examining a small seedling of a pine and anxiously waiting for someone to make it a pallet somewhere, someday, only then can you call yourself a devoted packing designer.”



### 14.2.1 Alternative packing materials used in Metso Minerals

Metso Minerals has been a pioneer when it comes to using alternate packing materials for example in cushioning the parts and ensuring that the materials that used to pack the parts are not only recyclable but can be used over almost indefinitely, such as the pallets and the pallet frames.

For example in France not only the wooden pallets are used to their capacity, but after all this all of the wooden materials are treated so that they can be used over and over again in several different purposes from cushioning to re-fabricating wooden crates.



(Pic.116) *recyclable packing materials made out of wood chips being stored in Macon, France*



(Pic.117) *cushioning material made out of corn is in every-day use in France.*

#### **14.2.2 Alternative packing materials for protecting the parts used in Metso Minerals**

Metso Minerals in Macon, France has been a pathfinder in using alternative and recyclable packing materials in their warehouses. As the Logistics Europe Project is introduced, the warehouse in France becomes obsolete. It is only desirable that the new, centralized warehouse remains in this favorable system of using these re-usable and recyclable packing materials. Training must be the key factor in this situation as well.

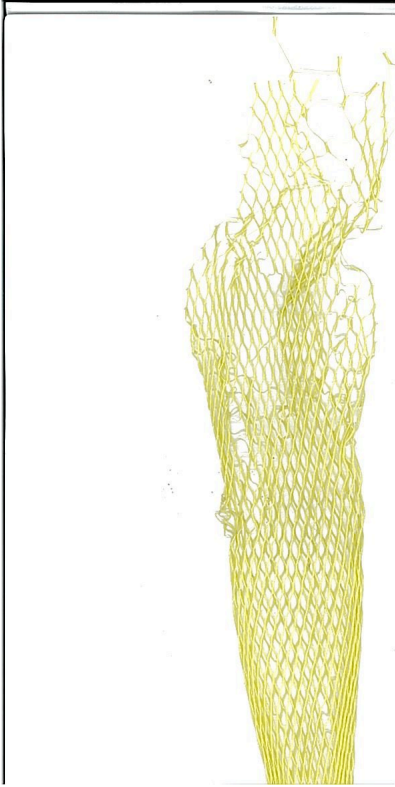

(Pic.118) a special “sock” made to protect any screwed ends of particular parts.



(Pic.119) biodegradable plastic wrapping is made out of a special thin plastic sheet.



(Pic.120) special sample packages have been designed to fit the round parts.

### 14.3 Storage space of packing materials in Metso Minerals

Cardboard takes up rooms-full of storage place and room to be storage for daily shipping. With the pallet frames that can be folded the storage space could be reduced to a minimum of the room required currently.



(Pic.121) rooms and rooms full of shipping cartons stored. There are also problems in replenishing the supply on regular bases. The pallets, which are still being used, also take up some room, however the frames are foldable and can be stored in a fraction of the space above.

#### 14.4 The use of pallet frames as the main packing materials in Metso Minerals

All sorts of wooden crates have been tested and explored in shipping critical parts for Metso Minerals. The iron-enforced pallet frames are durable, re-usable and most of all recyclable. The life cycle of these packing products is nearly unlimited.

In comparison to the simple and plain wooden box the frames (underneath in the photo) provide a long-lasting solution to a global standard of shipping. The frames can be supplied to the customers who need to return parts to Metso Minerals, the frames can also be provided to the original suppliers who pack the parts they have manufactured and then ship the parts to MM. This again eliminates the opening of the packages, providing that the correct labels are attached, and the part can go directly to re-shipping to a customer or to be stored on a shelf without ever re-packing it.



(Pic.122) a simple box on top of a set of pallet frames folded shows the Difference in quality, storability and reliability in the shipping process.



(Pic.123) even though the smaller wooden box might be sturdy, the Pallet frames are still the way to a new and secured way of shipping.

By using the pallets, frames, divider plates, bottom plates and lids in shipping critical parts, it would be worth to re-evaluate the insurance costs for the parcel since it can also lessen because the package is made to be more durable.



*(Pic.124) in this picture it is clear how the frames can easily be set on top of each other. Here the height of the shipment requires three pallet frames to be used.*

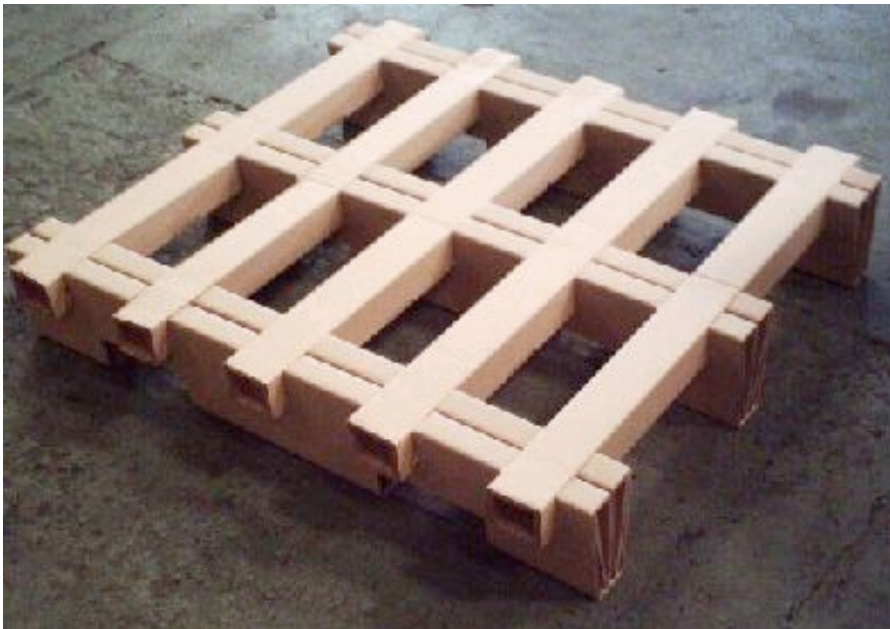

*(Pic.125) a super light-weight pallet made out of cardboard can revolutionize the usage of pallets in shipping. In order to get this pallet approved it needs to be accepted by the ISO standards and SOX needs.*

The “cartoon pallet” needs no fumigation because it is made out of cardboard and glue. It has a very high resistance and is made with impermeable resin.

## 14.5 Packing material alternatives from Finland

It is imperative to take into consideration the needs and the purpose of the end use of the product, as well as the demands of the supply chain, already in the product designing phase. On the basis of these factors the material, the dimensions, the structure and the visual aspect of the package are chosen. In case and when it is required, the internal parts of the package will be made precisely according to the demands of the product.



(Pic.126) *This particular Finnish company provides solutions for packing and will design a package with the customer's need in terms of logos etc.*



(Pic.127) *a special package with a filter on the top of the box is built for air ventilation/filtration.  
(Metso Minerals)*

## 14.6 Plywood boxes and Pallet Frames

Plywood boxes and pallets are in regular use in MM Tampere warehouse. They are durable and easy to use, but not very environmentally friendly. Pallets are easily broken when handled with forklifts and the ones coming from Estonia break even easier. Metal enforced plywood boxes are certainly long lasting, and they can be used again. The problem is that the plywood boxes that MM uses carries the company logo. No other company will want to use a shipping crate with another company's name on it. Therefore it is often discarded.

By transferring the shipping to pallets and pallet frames, the possible savings would be enormous. That procedure would also be kind to the environment since the receiving company could use the pallet frames over and over again without having to advertize another company. The multiple usage is possible, and the only thing the shipper has to remember is to take off the waybill pouches and other old address labels from the frames.

### 14.6.1 A plywood box

Some plywood boxes will be examined in the following text.

Foldy-Pac plywood box is made to order according to the customer's demands. What makes them special is the fact that the boxes are completely foldable and due to this ingenious design they can be used over and over again in even the harshest shipping conditions. These boxes are made in 3, 4 or 6 part assemblies depending on how the product, in this case MM parts, wish to be packed. These Foldy boxes are delivered to the customer already folded, piled and stacked so they only take minimal space in transporting or storing them. Before using the boxes in actual shipping the frame is bent open and the lid is attached either with a fast lock system or bendable locking latches. As the appropriate packing is done, the lid is secured. The fast locking system on the Foldy-Pac ensures a fast and a simple way of securing the parcel. It is strong, secure and it also can be re-used.

There is a down side to using plywood that is originated from Russia. It lets the water seep through.







(Pic128 & 129) *Pictures of the Foldy-Pacs.*

## 15 Pallets

All the parts of the pallet are obviously attached by nails. Some measurements are provided under the picture. Normally there are only two pallet sizes used in Finland. Many shipping and container filling problems could be avoided by introducing other different sized pallets in addition to the ones already in use.

EUR PALLET:

1=foot board

2=edge board

3=side board

4=support board

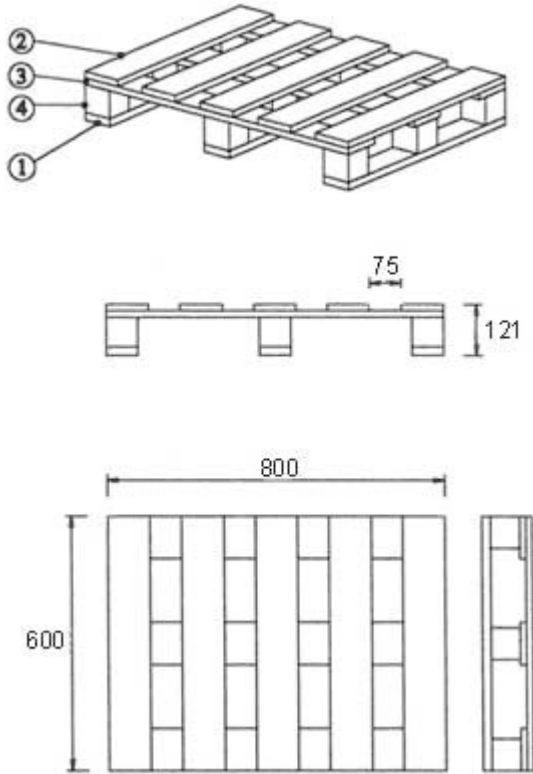

(Pic130) *measurements of a EURO pallet*

#### a. **Standard pallets**

There is a long tradition in fabricating FIN and EUR pallets in Finland. Although the pallets themselves are standard products there are still many differences in the quality of making the pallets. There are also production units and manufacturers that take into consideration the modern automation, production and packing standards when manufacturing the pallets. That makes the Finnish pallet manufacturing industry very accurate and functioning.

#### EURO PALLET

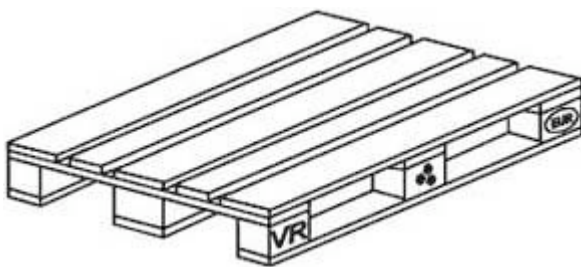

#### FIN PALLET

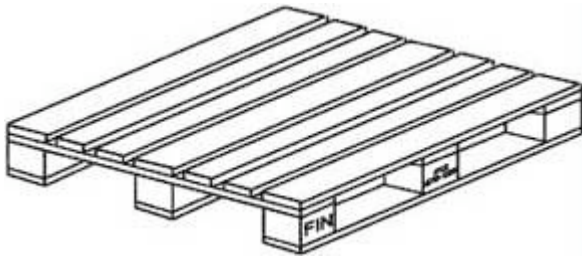

(Pic. 131 & 132) *Example pictures of an Fin pallet and a Euro pallet.*



(Pic.133) *an example of some light weight pallets.*

Most of the pallets used in Metso Minerals are made in Estonia. This is mainly for pricing and production volume assurance. Would it be possible to compare with pricing while still obtaining the quality of a Finnish-made pallet? The questions that I was unable to get answers were for example what is the cost of wood (pallets or otherwise) now in Estonia? Additionally, if Metso Minerals moves away from the Estonian provider, is it possible to get all the standard pallets and packing materials and perhaps include it into the pricing of the customer?

## **16 Labels**

In addition of the address labels containing detailed information on the shipper, the consignee, the payer, if a third party is in question, and all the other necessary paperwork that is required on the particular shipment, it is imperative for the package to contain the correct pick up and/or center of gravity points. If a normal fork-lift handling is not possible these markings are mandatory. Other markings should contain the required temperature, toxicity (if applicable), flammability (if needed) and other ADR markings such as durability and so on. In all packages a separate address label and a separate waybill should be indicated. Packing lists should be attached on the outside of the box, on the pallet if multiple boxes and one inside in case the others are lost. It is also recommended that address labels and packing list

be placed inside the parcel as well. The labels are recommended to be attached on the short side of the lowest pallet frame. When pallet frames are used, the labels should be placed in between the two frames. This way, when the frames are separated from each other all the labels from previous shipments are torn off and this way removed before re-using the pallet frames. If a box is used instead of a pallet frame, all the labels should be attached directly on to the box in the most clear and visible place.

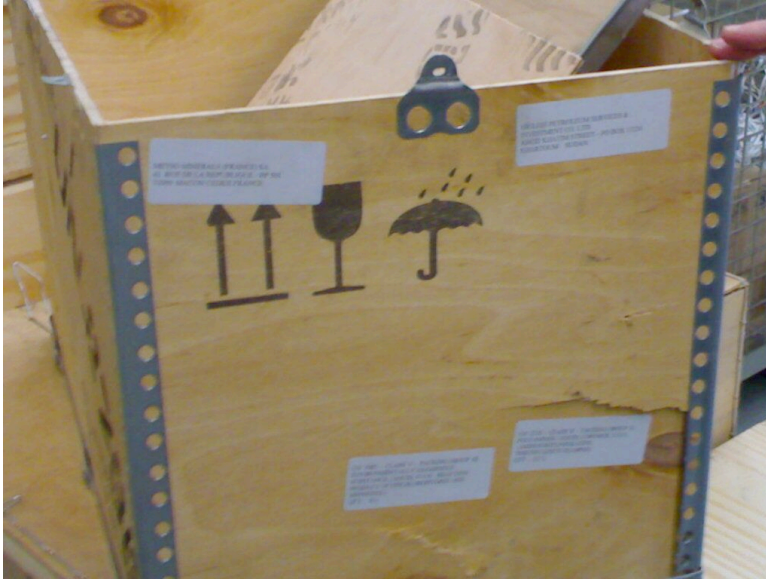

(Pic.134) a very good example of a plywood box where the markings clearly indicate that this shipment is fragile (picture of a glass), must be covered from moisture/humidity (the umbrella) and shows which side is up.

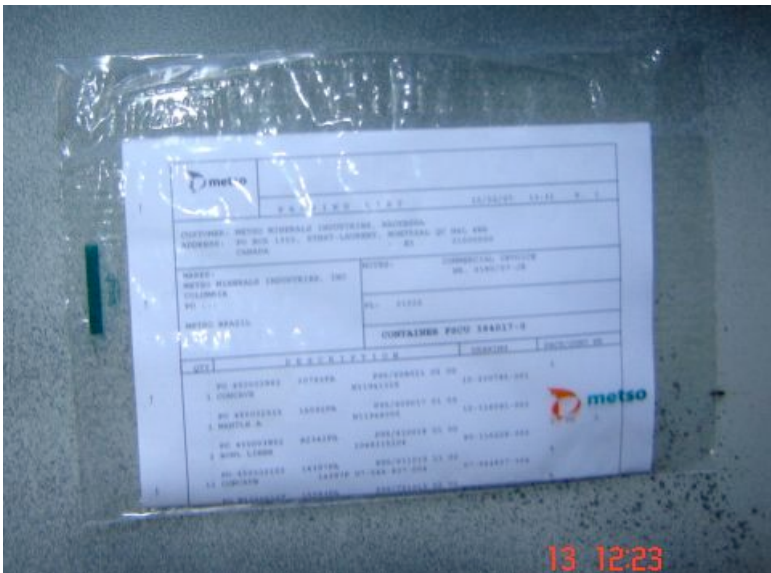

(Pic.135) an example of a plastic pouch that covers the waybill and address labels.

## 16.1 Invoices

There are many different forms of invoices. An invoice is actually a bill or a sales invoice therefore most of the companies have their own invoice format. An invoice is a document

used in any commercial areas and is basically an agreement between the organization that is selling a product and the customer. A basic sales invoice in Metso Minerals consists of the part/parts that are sold (usually the part identification numbers), the number of the items and most importantly the price that MM is charging the customer for. There are also terms of payment on the invoice. The terms indicate how and when the payment is due. There are also several different types of invoices but all of them must or at least should contain the actual word invoice, the date of the invoice, a reference number that identifies that particular invoice (i.e. an invoice number), the name and all necessary contact information of the seller and the buyer, the tax and company registration details, the date when the part or parts were sold and/or delivered and a description of the part (item number is mostly used in addition to a description of the part), a purchase order number, a unit and the total price charged by Metso Minerals and the payment terms.

**metso minerals**  
**Metso Minerals (South Africa) (Pty) Ltd**  
 Company Registration No. 1988009489/07  
 ROC Southern Africa PA 800018 SA CEC108

**MININGS PLANT:**  
 40 Street Street  
 Springs, Springs  
 KwaZulu Natal  
 P.O. Box 124  
 Springs, 3300  
 Republic of South Africa  
 Tel: (031) 450-2000  
 Fax: (031) 450-2450

**REFURBISHING PLANT:**  
 40 Street Street  
 Springs, Springs  
 KwaZulu Natal  
 P.O. Box 124  
 Springs, 3300  
 Republic of South Africa  
 Tel: (031) 450-2000  
 Fax: (031) 450-2450

**ACCOUNTS & SALES:**  
 Johannesburg  
 54 Jor Park Road  
 Johannesburg  
 P.O. Box 1492  
 Johannesburg, 2000  
 South Africa  
 Tel: (011) 351-6000  
 Fax: (011) 351-6360

**TAX INVOICE**  
 No: 90057021  
 Date: 02/22/2007

Customer Order: VAT Reg.No.  
 M126000439 4780101731  
 Invoice: 4780101731  
 Mode of Transport:  
 DDU COLUMBIA  
 Delivery note: 80058909

Contract/Order No. \_\_\_\_\_  
 Contact Person: \_\_\_\_\_  
 Remarks: \_\_\_\_\_  
 ATTN: TINA LOBSCH

Customer Ref. No. \_\_\_\_\_  
 Order No. \_\_\_\_\_  
 Invoice No. \_\_\_\_\_

Part number	Matl grp	Description	Quantity	Unit Price	Amount
1062807441	2400	OIL FLINGER	1.00	843.00	843.00 USD

HIS 0005 8474 30 0020 FOR ALL PARTS UNLESS OTHERWISE STATED  
 INV 3D 10600710

Customer VAT Reg.No. \_\_\_\_\_  
 NRSBY 98642

Deliver to:  
 METSO MINERALS INDUSTRIES, INC  
 CS-EDC WAREHOUSE  
 10145 TWO MORCH RD (US 1 N.)  
 COLUMBIA, SC 2922-4388  
 USA

Invoice to:  
 METSO MINERALS INDUSTRIES INC.  
 P.O. BOX 1302  
 STN ST-LAURENT MONTREAL  
 H4T 4N6  
 CANADA

**IMPORTANT**  
 All returns to be made to our office at Springs No 1287/1236, a 15% handling charge will be made on goods returned without our permission. No claims for insurance etc. will be recognized after 10 days. Goods will be shipped unless our order no shows above. All goods returned must be accompanied by original invoice dated within 30 days and must be accompanied by a copy of the invoice. Please advise our office of any changes to the invoice. A copy of this invoice dated 01 August 1999, a copy of which is in your possession.

FOB	843.00
LESS DISCOUNT	
TOTAL FOB	843.00
FREIGHT	9.00
INSURANCE	
NET-AMOUNT	852.00
AMOUNT DUE	852.00

(Pic.136) a copy of an invoice from Metso Minerals, South Africa.

### 16.1.1 Variations of invoices

There are numerous variations of invoices used around the world. In foreign trade a pro forma invoice is used. A pro forma invoice is most often used only to declare a commitment between the buyer and seller that something is being sold to someone at a certain price. Therefore the pro forma invoice is not actually a bill like the regular invoice is. Pro forma

invoice is usually not issued until all the terms of the trade are agreed by the buyer and the seller.

A commercial invoice is used in international sales as a customs declaration. A commercial invoice must contain all the relevant information of the buyer and the seller, of what is being sold and transported through the customs, and most importantly the value of the parts or items that are sold. The customs require specific information to appear on a commercial invoice. The commercial invoice is also used to calculate tariffs.

A packing slip can also act as an invoice. This is called an Evaluated Receipt Settlement or ERS. ERS works basically so that as the customer receives the parts that Metso Minerals has sent, they confirm delivery and receipt of the parts and pay the bill according to the packing slip. This is usually only used in Metso Minerals' internal shipping procedures, when the shipper and the consignee are both, for example a Distribution Center, of Metso Minerals.



*(Pic.137) packing slips are attached on pallet frames so that they cover more than one frame. This way when the frames are re-used, the old pouches of packing slips are automatically torn off.*

## **17 Future legal issues**

There is a reform occurring in the legalities of cargo shipping. It is estimated that the center of gravity point will have to be marked in containers weighing over one ton. If the point is not marked the shipper will be liable for any damage that might take place.



(Pic.138) a cargo container being hoisted.  
 This picture explains why the marked center of gravity points are so important.

The essence in maximizing the use of a container capacity is to stuff the most cubes (i.e., largest cubic measurement) into a container that would give the lowest freight cost. If the capacity of a container is 1,170 cu. ft., it does not mean that the exporter must (or can) fully stuff it up to 1,170 cu. ft.. This can seldom be done due to the restrictions imposed by the kind of cargo and the type and size of the export pack.

The freight cost per cubic unit generally is lower when more cubes are stuffed into a container. However, when the total cube is too close to the container capacity, unloading and reloading of container may happen. The cost of extra time and labor spent on unloading and reloading usually is much more than the unit cost of freight saved for stuffing in more cubes. It would be fortunate if there is no **cargo overflow**---a situation where some export packs cannot fit into the container because the remaining space does not accommodate the size of the packs. The recommended load volume provides a guide in calculating a full container load (FCL), which helps in avoiding cargo overflow.

Possibilities:

- Outsourcing of certain pre-fabrication of higher quality packaging i.e. with a partner.
- Identify most of the wear and spare parts that are to be looked at more closely in regards to packing.

Sources:

Savopack – plywood

OR-Group

CLO PAKKAUS – pallets

Evira.fi – kasvinsuojelu pakkaukset

[www.pakkausjaloste.fi](http://www.pakkausjaloste.fi)

[www.pakkausohman.com/vanerilaatikot/vanerilaatikot.htm](http://www.pakkausohman.com/vanerilaatikot/vanerilaatikot.htm)

[www.saarset.fi](http://www.saarset.fi)

[www.or-group.fi](http://www.or-group.fi)

## 18 Costs

If the shipping is outsourced or an outside party is used when consolidating the shipping process it is important to take into account at least three different service providers. A feasibility study and a cost comparison should be made when choosing an outside party who will take care of shipping as the Macon, France location considers. Keeping in mind the investments and the requirements for haulage in both the acquiring process as well as during the mass production of the packaging process is important. The quantity and type of packing processes, haulage volume (m<sup>3</sup>/truck), the amount of packaging waste generated and quality deviation reports will act as performance measures of the process.

Economical transportation and packaging can and should already be taken into consideration when designing the original product. This is a fool proof way to impact the over all cost of transportation. The product design team should consider what type of new products are launched and how can they be transported to the customer in a cost efficient way. The team should also compare any new products to a possible similar product already in use and the method of its shipping. In case any changes should be done, the product design team should consider if the changes should be made to the product itself or the method of transportation. Also the racks that should be taken into use could easily be modified to carry other types of products.

Due to the analytical point of view of this thesis it is impossible to provide actual numbers in the savings that would be made if transferred to shipping with minimum of four different sized pallets, pallet frames, divider plates, bottoms and lids. The prediction of savings could be from 30-50% due to a more efficient use of space in trailers and containers. This would also amount to hundreds of thousands of Euros of savings per year.

If the shipping is outsourced or an outside party is used when consolidating the shipping process it is important to take into account at least three different service providers. A feasibility study and a cost comparison should be made when choosing an outside party who will take care of shipping as is done in the Macon, France location. Outsourcing the shipping after implementing the Logistics Europe Project would eventually save money, time and increase customer satisfaction.

Keeping in mind the investments and the requirements for haulage in both the acquiring process as well as during the mass production of the packaging process is important. The



quantity and type of packing processes, haulage volume (m<sup>3</sup>/truck), the amount of packaging waste generated and quality deviation reports would act as performance measures of the process.

Economical transportation and green values in packaging can and should already be taken into consideration when designing the original product. This is a fool-proof way to impact the over all cost of transportation. The product design team should consider what type of new products are launched and how can they be transported to the customer in the most cost efficient way while still remaining environmentally friendly. The team should also compare any new products to a possible similar product already in use and the method of its shipping. In case any changes should be done, the product design team should consider whether the changes should be made to the product itself or the method of transportation. Also the pallets that should be taken into use could easily be modified to carry other types of products.

An example of using sea freight cardboard versus the pallet frame system, the cardboard will most likely not be used twice and hardly ever three times. This proves that using the cardboard Metso Minerals and its customers only get one use out of the box. Comparing this fact to the pallet frame system, which possess nearly unlimited usage times would not only save the company money, but would also save the nature (=green logistics). This would in turn enhance the company image even further while also reducing damages.

### **18.1 An example of cost of manufacturing and repairing a pallet**

The following is an example of the pricing of one company for repairing and manufacturing pallets. This is based on a yearly payment structure.

#### **18.1.1 Manufacturing**

A fixed cost:

- FIN pallet 480€
- EUR pallet 660€
- Both 950€

An additional payment of 0.5% for the sales that exceed 150 000€ of all SFS marked products. The maximum annual price is 4000€.

The annual yearly payment will be billed according to the turnover information of the previous year.

### 18.1.2 Repair

The cost of the repairs of the pallets is based on the pallets repaired the previous year as follows:

Repaired pallets amount in pieces	One pallet size	Two pallet sizes
1 – 5000	200€	300€
5001 – 10 000	230€	380€
10 001 – 30 000	290€	500€
30 001 – 100 000	400€	650€
Over 100 000	650€	1100€

There is an 85€ charge added on top of the permit charges. The 85€ covers the EPP (European Pallet Pool) tuition for the current year.

### 18.1.3 Costs for the quality inspections:

On top of regular charges, there is a quality inspection charge that is billed by Inspecta Sertificate. Inspecta Sertificate inspects the quality of the pallets, randomly. The charges are as follows:

Making of a pallet, two sorts:	535€
Making of a pallet, on sort:	445€
Fixing of two sorts of pallets:	400€
Fixing of one sort of a pallet:	360€
Audit of a pallet center:	360€
Audit & inspection of a center:	135€

### 18.1.4 Other services

Expertise advise and anything else that doesn't include the regular inspection will be charged 140€ for every hour and 70€ per hour for travel expense. A federal tax of 22% is not included in the prices.

By implementing the LEP and investing capital into moving towards the shipping with the pallet frame system, Metso Minerals would improve the way of packing so that eventually the company would save money, gain customer satisfaction by shortening delivery times, reduce damages and improve customer satisfaction and the company image.

## Summary

### Future possibilities

This work could also later be valuable if brought to the attention of the sales and pricing personnel. When calculating prices the price of the part could be re-evaluated if it needs any special attention when shipping. Re-pricing could help to pay for any kind of new packing materials that might be suggested in the thesis.

At the moment the order office in Metso Minerals is not able to provide the customer with a price on the phone. If the packing costs and the part price were known, Metso Minerals would be able to quote the price including shipping and later possibly send the order electronically to the shipping department. This process could be enhanced with SAP or other ERP system.

The possibilities to improve are potentially high since, due to the future instructions manual, the packing materials would be known beforehand. Therefore the cost of the packing could be included in the part price, the time to pack a part could be calculated thus making the packing process more time efficient and the warehouse staff could improve their overall efficiency.

The instructions could also be carried over to the parts arriving from manufacturers. If they were provided with Metso Minerals standards of packing, the parts would be able to be kept in storage already to be picked by the picking staff and shipped as is. This would eliminate the opening of arriving parcels and the time and money it takes to re-pack the parts when further shipping them to customers. This could be made possible by providing blank materials and the global instructions to the manufacturers beforehand.

Methods described above could also lead to a new package identification process in Metso Minerals. If all parts could be tagged with barcodes, the entire supply chain stands to improve to be more time and cost efficient.

The main idea of this work, however, is to ease the packing of difficult items (above) and to keep the instructions very simple, manageable and feasible. The thesis also acts as ground work for a shipping manual. A manual can be directly made from the materials gathered in this thesis. It will also be linked to the subcontractor agreement in the L.E.P. project and a contract made at the completion of that project.

Future ultimate benefits for the customer and Metso Minerals:

- **Delivery accuracy** improves by the use of a global *unified packing manual*. This enables the warehouse staff have the weight, the measurements, the correct sort of packing materials and the most suitable way of shipping. All this information is at the staff's reach and on hand immediately when packing each and every package.
- **Customer satisfaction** will reach significantly higher markings in surveys taken. That means that as the customers receive their packages undamaged (due to correct packing) they can immediately resume the work and are happy and satisfied. Needless to say as damages are eliminated, money is saved.
- **Less damages.** As the packages have a manual that shows (in photographs) what materials to use and how to pack critical parts the amounts of damages are minimized. The less damages the less returns, the less idle time for crusher users and the less time and money spent for repairs. The less replacement parts have to be sent and the less money to build new parts. The less dissatisfied customers thus the more re-orders and higher customer retention.
- **Metso Minerals shows green values** as stated in [www.metso.com](http://www.metso.com) – “Think Green”. All the packing materials have the possibility to be able to be made from environmentally safe and biodegradable materials. The packing materials suggested in this work are mostly re-usable and compostable. What would be more valuable for the company image than the “green- image”?
- **Reduction of shipping costs.** A drastic fall on the cost of shipping would eventually be the pay-off for first acquiring some new shipping materials, even little by little so the cost could be divided evenly on the yearly or even quarterly budgets. As the new material allows the parts to be stacked on top of each other, the lashing will be easier and the trailers and container space can be used up to the maximum potential that the space can be used. When using the container space in its entirety or partially without paying for the empty space saves Metso Corporation a significant amount of money.

## ABBREVIATIONS/TERMINOLOGY:

There are several abbreviations and terms used in this thesis that are explained in more or less detail in this section of the work. Some of the terminology might already be familiar to the reader, however, for clarity they will be explained to make sure the entire text is understandable regardless of the reader.

This work contains 138 photographs and 9 tables.

IPPC: International Plant Protection Convention is a treaty organization that works to prevent the international spread of plant deceases. Among its functions are the maintenance of lists of plant pests, tracking of pest outbreaks and coordination of technical assistance between member nations.

Due to the International Plant Protection Convention, most pallets shipped across national borders must be made of materials that are incapable of being a carrier of invasive species or insects and plant deceases. The standards for these pallets are specified in ISPM15.

ISPM15: ISPM15 is a Phytosanitary Measure developed by the IPPC and directly addresses the need to sanitize certain materials used to ship products between the countries.

Pallets made of raw, untreated wood are not compliant with the ISPM15. To be compliant the pallets must be treated by either of the following means, under the supervision of an approved agency.

- First method of treatment: heat treatment. The wood must be heated to achieve a minimum core temperature of 56°C for at least 30 minutes. Pallets treated with this method bear the initials HT by the IPPC logo.
- Second method of treatment is fumigation. The wood must be fumigated with methyl bromide. Pallets treated with this method are marked with the initials MB by the IPPC.

3P Pricing: In the LEP section of the thesis, 3P pricing becomes an issue. Some marketing experts might be talking about a 4P pricing instead, where the first P would stand for the Product or the Product strategy, but this is really nothing more than positioning, which itself includes virtually all aspects of how a product should be designed to be perceived by a consumer. After the strategic positioning of a product is made, there are only tactical marketing mix variables to decide. This is then the “3P’s”. And there is only one logical order for the 3 P’s and that is Price, then Place and then Promotion.

DC: There are a lot of referrals to the letters DC. They simply stand for a Distribution Center which Metso Minerals has located globally. DC's carry inventory and receive parts from a supplier. It also ships packages so the DC usually also has a warehouse.

LSU: Local Sales Unit carries Metso inventory and sells it onwards to customers.

ROI: ROI stands for Return on Investment. This was briefly touched on the packaging part, where the changing cost of packaging materials would pay itself back within a year or so.

SCM: SCM should already be in everyone's knowledge base of logistics, but once more it stands for Supply Chain Management.

RID: Regulations concerning the international carriage of dangerous goods by rail.

ADR: Regulations concerning the international carriage of dangerous goods by road.

O.S.S: Open Side Setting of the angle of the crusher's jaw

C.S.S: Closed Side Setting

- When attaching the jaws, the settings of the length on how narrow the opening of the movable jaw - the jaw will hit the stable one - determine the size of the rock that comes out of the crusher. A close side setting, when the moving jaw is closest to the fixed jaw, produces the smallest grain of rock. In other words the size of the desired rock size is determined by the variation of the open and close side settings of the jaws.
- The length or the stroke, for example 10 – 50 mm, is adjusted according to the size of the crusher and according to the acquired size of the end product.
- OSS-CSS=STROKE

EUR: Refers to a EUR pallet which is the most used and standardized pallet in Europe

FIN: Refers to a FIN pallet which is the most used and standardized pallet in Finland.

RFID system: RFID system is short from a Radio Frequency Identification System. It is widely used in the shipping industry and functions on radio frequency. It is especially valuable in identifying parcels while in transit.

**BARCODE SYSTEMS:** Barcode systems are also used in transportation. As the shipper places a barcode sticker on the parcel he is shipping it usually contains a unique number which is then scanned at different locations to locate the parcel.

**RID regulations:** RID regulations are rules governing the carriage of dangerous goods by rail.

**ADR regulations:** ADR regulations stand for the European Agreement concerning the International Carriage of Dangerous goods by roadways.

**STOWAGE percentage/Fill Rate:** Containers vary according to their sizes, shapes and uses, it is important when filling a container of any kind to make sure there is no empty spaces left between the items packed.

**WIP:** Work In Process

**ERP system:** Enterprise Resource Planning

**ISO 9001:** ISO 9001 is a collection of standards that measure an organization's quality leadership, quality products and items- as well as service production

**ABC analysis** is used to measure SCM (Supply Chain Managements) success, purchasing and procurement, sales forecasting, production planning and control, inventory management, material handling, warehousing, transportation, and

**KPIs:** Key Performance Indicators of a company

**MM:** Metso Minerals

**End User/Customer:** A customer or a user of a product that is the final connection in the supply chain.



## Sources/References:

A brochure from marketing Institute

Taloussanomat 6.2.2008

[www.metso.com](http://www.metso.com)

Quality training participation in 2006

[www.metsominerals.com](http://www.metsominerals.com)

ZERUST-registered trademark Corrosion Prevention Solutions Pamphlet

Journal of Biophysics and Biochemical Cytology 2, 799-802

Chemical Equilibrium Database and Plotting Software (2004)

Royal Institute of Technology, freely downloadable software

[www.osha.gov/dts/chemicalsampling/data/CH\\_250190.html](http://www.osha.gov/dts/chemicalsampling/data/CH_250190.html)

Product support training in Metso Minerals 2006

Innolink for Metso Minerals

Damage reports from South Africa and USA

A collaboration meeting with Heikki Kivijärvi, the Logistics Manager MM, Tampere 2006

A meeting with the warehouse manager in Macon, France

[www.tres.elblag.com.pl/eng/glowna.php](http://www.tres.elblag.com.pl/eng/glowna.php)

[www.1logistics.com.pl/en/main.xml](http://www.1logistics.com.pl/en/main.xml)

[www.elkas.de](http://www.elkas.de)

[www.piccolo-kul.de](http://www.piccolo-kul.de)

<http://josta.mx2.vnet.de>

A meeting with the Logistics Manager Heikki Kivijärvi in 2007

Savopack - plywood

CLO PAKKAUS – pallets

Evira.fi – kasvinsuojelu pakkaukset

[www.pakkausjaloste.fi](http://www.pakkausjaloste.fi)

[www.pakkausohman.com/vanerilaatikot/vanerilaatikot.htm](http://www.pakkausohman.com/vanerilaatikot/vanerilaatikot.htm)

[www.saarset.fi](http://www.saarset.fi)

[www.or-group.fi](http://www.or-group.fi)

Supply Chain mgmt and advanced planning – Concepts, Models, Software and case studies by Hartmunt Stadler and Christoph Kilger 3<sup>rd</sup> edition, 2005 Springer

Jouni Sakki: Käytännön materiaalinohjaus kaupassa ja teollisuudessa. Oy Weilin&Göös Ab. Tapiola. 1986

R. J. Schonberger: Tuotantotekniikan japanilaiset mallit. Oy Rastor Ab. 1989.  
Tuotannonohjauksen tietotekniikka. Kurssimateriaali.

Kivialan ammattioppi 2, louhinta. Opetushallitus. Helsinki. 1989.

Rock Excavation Handbook. (for civil engineering) Sandvik. Tamrock. 1999.

Blake R, Morton J: Johtamisen psykologiaa. 5. Painos. Weilin&Göös. Tapiola 1975.

Pauli Miettinen. Tuotannonohjaus ja logistiikka. ATK-instituutti. Painatuskeskus Oy. Helsinki.1993.

Kai Ruuska. Projekti hallintaan. 4. painos. Gummerus Oy. Jyväskylä 2001.

Howard L. Hartman. SME Mining engineering handbook, 1992.

Tamrock. Underground drilling and loading handbook. 1997.