

# Retrofitting an electrostatic precipitator into a hybrid electrostatic precipitator by installing a pulse-jet fabric filter

Review of available technologies for retrofitting Electrostatic precipitator with fabric filter

Petri Roberto Eskelinen

Helsinki Metropolia University of Applied Sciences

Degree Bachelor in Engineering

Degree Programme: Degree Programme in Environmental  
Engineering

Thesis

|  |   |
|--|---|
| Author(s)<br>Title<br>Number of Pages<br>Date  | Petri Roberto Eskelinen<br>Retrofitting an electrostatic precipitator into a hybrid electrostatic precipitator by in-stalling a pulse-jet fabric filter: Review of available technologies<br>73 pages + 2 appendices<br>12 May 2015 |
| Degree   | Environmental Engineering   |
| Degree Programme   | Degree Programme in Environmental Engineering   |
| Specialisation option  | Energy  |
| Instructor(s)  | Antti Tohka, senior lecturer<br>Minna Paananen-Porkka, senior lecturer  |
| <p>The tightening of regulations related to particle emissions has made retrofitting the ESP into a hybrid of the ESP and a baghouse filter a possible solution to some old plants in Finland. The objective of this thesis was to assess when this is a viable option and to study the advantage and limitations of the system by comparing it to other options available to companies when they need to have more efficient filters.</p> <p>For this purpose, it was necessary to compile the pricing of a new ESP and bag house filter and compare it to the price of retrofitting an ESP in Finland and estimate its maintenance and operation cost.</p> <p>To achieve this, the following procedure was necessary:</p> <ul style="list-style-type: none"> <li>• study how a hybrid ESP is built and how it operates</li> <li>• compare a hybrid ESP to a conventional ESP and bag house filter to determine its limitations</li> <li>• compile an overview of the technologies behind an electrostatic precipitator, a bag house filter and a hybrid ESP-Bag house filter to illustrate their limitations and to determine when these technologies could be applied.</li> <li>• find out suppliers, their prices and options for the various parts of the Hybrid ESP-bag house filter, and the solutions they provide for some parts, such as valves, filter bags, the bag cage and the control system, if biofuel is used.</li> </ul> <p>The option for the filter was found and it was possible to give a general idea of how many of the options would affect the filter. An example process was used to better illustrate how the options affect the filter. It was also possible to derive the cost of operation and construction of the filter and compare it to that of a new ESP and bag house filter and give an overview of its advantages and disadvantages.</p> <p>In conclusion, there are processes where satisfactory results cannot be achieved by an ESP; thus, a fabric filter may become necessary and its operation cost are not always greater than those of an ESP.</p> |   |
| Keywords   | retrofit, ESP, fabric filter, hybrid, pressure drop   |

## **Acknowledgement**

The thesis is one of the first valuable achievement I manage to accomplish in Finland and is seen as a milestone in my life.

First and foremost, I wish to thank ECP group generous opportunity to work with them on this project without which this thesis project could not have been carried out.

It has been a great pleasure to study and write about this subject as it seems relevant to the protection of our planet and running a more sustainable economy and is my belief that there will be opportunities in the area of air pollution control more than ever before.

I would like to give appreciation to my two supervisors, Antti Tohka and Minna Paananen-Porkka, for helping me put this thesis together.

I also wish to thank the staff of the Environmental Engineering degree programme including of course every teacher and staff member from the degree programme in Environmental Engineering at Helsinki Metropolia University of Applied Sciences for the exemplary work provided by them.

My colleagues that accompanied me during the studies at Metropolia and helped me with various tasks also have my thanks.

Any faulty information in this thesis is only my own responsibility and not of any person being mentioned.

Petri R Eskelinen  
Vantaa, Finland

## Nomenclature

|               |                                    |                    |
|---------------|------------------------------------|--------------------|
| $k_1$         | Fabric resistance usually in       | Pa/m/s             |
| $k_2$         | Dust cake resistance usually in    | Pa/m/s             |
| $dp$          | Pressure drop/ pressure difference | Pa                 |
| $L$           | Length                             | m                  |
| $V_f$         | Filtration velocity                | m/min              |
| $U_a$         | Air dynamic viscosity at 20 C      | Pa*s               |
| $T_g$         | Gas temperature                    | °C                 |
| $\varepsilon$ | Porosity or fraction void volume   |                    |
| $C_i$         | Dust concentration loading         | g/cm               |
| $H$           | Annual operating time              | h                  |
| $K$           | Power Cost                         | Euro/kWh           |
| $S$           | Design capacity of bag house       | m <sup>3</sup> /s  |
| $C$           | Conversion constant                |                    |
| $E$           | Fan efficiency                     | %                  |
| $FP$          | Fan power requirement              | kWh/year           |
| $Q$           | System flow rate                   | m <sup>3</sup> /s) |
| $P$           | System pressure drop               | pa)                |
| $t$           | Annual operating time              | h/year             |
| $\eta$        | Efficiency                         |                    |

## Abbreviations

|          |   |
|----------|---|
| ESP      | Electrostatic precipitator                                |
| FF       | Fabric filter/bag house filter                            |
| TCI      | Total capital investment                                  |
| PJFF     | Pulse jet fabric filter                                   |
| ID       | Induced Draft   |
| PJFF-ESP | Pulse jet fabric filter electrostatic precipitator hybrid |
| SCA      | Specific collection area                                  |
| LP       | Low Pressure  |
| HP       | High Pressure   |
| MP       | Medium Pressure/Intermediate Pressure                     |
| HPLV     | High Pressure Low Volume                                  |
| IPIV     | Intermediate Pressure Intermediate Volume                 |
| LPHV     | Low Pressure High Volume                                  |

# Table of Contents

|       |   |    |
|-------|---|----|
| 1     | Introduction  | 1  |
| 2     | Legislation related to dust emission                              | 1  |
| 3     | Overview of ESP   | 3  |
| 3.1   | ESP nomenclature  | 5  |
| 4     | Overview of the fabric filter                                     | 6  |
| 4.1   | ESP and Fabric filter comparison                                  | 9  |
| 4.2   | Design of pulse jet fabric filter                                 | 11 |
| 4.3   | Header tank   | 13 |
| 4.4   | Pulse valve   | 16 |
| 4.5   | Blowpipe  | 17 |
| 4.6   | Venture   | 20 |
| 4.7   | Bag cages   | 22 |
| 4.8   | Tube sheet  | 28 |
| 4.9   | Fabric options  | 28 |
| 4.9.1 | Fibreglass.   | 29 |
| 4.9.2 | Homopolymer Acrylic (PAN)   | 30 |
| 4.9.3 | Polyphenylene Sulfar (PPS)  | 30 |
| 4.9.4 | Polyimide (P84)   | 31 |
| 4.9.5 | Polytetrafluoroethylene (PTFE)                                    | 31 |
| 4.10  | Fabric treatments   | 33 |
| 4.11  | Bag life  | 36 |
| 4.12  | ID Fan  | 37 |
| 4.13  | Control Unit  | 38 |
| 4.14  | Theory related to fabric filter                                   | 39 |
| 5     | ESP-FF retrofit   | 47 |
| 5.1   | Calculation   | 52 |
| 6     | Price comparison between filter options                           | 52 |
| 6.1   | Prices estimate for Construction and choosing materials           | 53 |
| 7     | Introduction to the case specific ESP-FF retrofit                 | 60 |
| 8     | Conclusion  | 69 |
| 9     | REFERENCES  | 71 |
|       | Appendices  | 1  |
|       | Appendix 1. Option cost estimates.                                | 1  |
|       | Appendix 2. Information about the conditions in the fabric filter | 3  |

## 1 Introduction

In the field of air pollution control there are many options that over the years have become available such as ESP and fabric filter whose use has become more important with the an ever increasing emission limits.

As the emission standards become stricter, plant owners that operate an ESP are more pressured to implement these standards; therefore, to be able to follow the limits set by regulating agency retrofitting the ESP to an ESP fabric filter hybrid can become an interesting alternative solution.

To present this option to the public, an overview of the technologies behind fabric filters and an ESP was compiled, and a study on the current viability of the retrofit project was conducted.

This thesis offers an overview of the ESP and Fabric filter solution and shows how this knowledge can be used to upgrade existing ESP in to ESP fabric filter hybrid and when such upgrade is worthwhile.

The thesis starts with a small summary of the reasons for upgrading the filter and then presents the basics of an ESP and its limitations. After that, there is a chapter on the fabric filter with a much in depth information on the subject, as the retrofitting is more related to fabric filters.

In relation to fabric filter, this document provides a list of parts and their function and some theory on how they behave.

The thesis ends with a summary of the hybrid filter, a cost comparison of the filters and a presentation of other data that can illustrate if such an upgrade is worthwhile.

## 2 Legislation related to dust emission

The E.U has created directives that affect power plants and these are relevant when reviewing emissions of dust control equipment as they are the reason the equipment is usually operated.

The EU level legislation applies only to large plants of more than 50 MW, but there are discussions for preparing a legislation that would apply to medium plants of 1 to 50 MW and another that would apply to smaller apparatus.

The Large Combustion Plants Directive aims to reduce acidification, ground level ozone and particles throughout Europe by controlling emissions of sulphur dioxide (SO<sub>2</sub>) and nitrogen oxides (NO<sub>x</sub>) and dust (particulate matter (PM)) from large combustion plants (LCPs) in power stations, petroleum refineries, steelworks and other industrial processes running on solid, liquid or gaseous fuel.[1]

However, the most important aspect is probably the dust emission limit (PM) as that is where both fabric filter and ESP work best.

Table 1 below gives the PM emission levels for various appliance types.

Table 1. Achievable best-practice PM emission levels of various appliance types for bio-mass combustion under ideal conditions.

| Appliance type              | Abatement technology | Achievable PM emission level mg/MJ | Achievable PM emission level mg/m <sub>n</sub> <sup>3</sup> at 13% O <sub>2</sub> |
|-----------------------------|----------------------|------------------------------------|---|
| Automatic combustion plants | multi cyclone        | 50 - 100                           | 75 - 150  |
|                             | simple ESP           | 15 - 35                            | 20 - 50   |
|                             | improved ESP         | 5 - 15                             | < 10 - 20   |
|                             | fabric filter        | < 5                                | < 10  |
|                             |                      |                                    |   |

The minimum requirement for large coal power plants is the annual ceiling with a linear decrease.

At EU level, it is already thought that new power plants should work under 20 mg/m<sup>3</sup> of dust control this can be achieved by ESP, but is rather difficult especially if problematic fuels are used.

Depending how the legislation progresses, is a possibility that in 20 years the limit could be as low as 5 mg/m<sup>3</sup> dust emission.

This would open a possibility for new market in regard to dust control at least in Europe. As there is also a demand for green energy, there is the possibility that coal plant start operating with biomass and that may make a better filtration system necessary. [2]

### 3 Overview of ESP

An electrostatic precipitator (ESP) is a highly efficient filtration device that removes fine particles, like dust and smoke, from a flowing gas using the force of an induced electrostatic charge minimally impeding the flow of gases through the unit.

The basic design criteria for ESP is the determination of the principal parameters for precipitator sizing, electrode arrangement and the electrical energy needed to provide specified levels of performance.

Specific collection area (SCA)

The collection surface of an ESP required for a given gas flow and efficiency is usually computed from the modified Deutsch-Anderson Equation:

$$n = 1 - \exp\left(-w \frac{A}{Q}\right)$$

Where  $w$  is ...,  $A$  is ... and  $Q$  is

The practical values of SCA usually range between 140 and 250  $\text{m}^2/\text{m}^3/\text{s}$ , the higher values for higher collection efficiency.

Gas velocity

The importance of gas velocity is in relation to rapping and re-entrainment losses of fly ash from the collecting electrode. Above a critical velocity, these losses tend to increase rapidly. The critical velocity depends upon the composition, temperature and pressure of gas flow, plate configuration, and ESP size. The gas velocity is calculated from the gas flow and cross section of ESP. The maximum gas velocity is 1.1 m/s and the optimum limit is 0.8 m/s for high efficiency ESP. [3]

Aspect ratio



The importance of aspect ratio is due to its effect on rapping loss. Aspect ratio is defined as the ratio of the total active length of the fields to the height of the field. Collected fly ash is released upon rapping and is carried along the gas flow path. If the total field length is too short compared to height, some of the carried particles will not reach the hopper and go out. The minimum aspect ratio should be around 1.8 to 2.4; the highest figure is for highest efficiency.

As to the high tension sectionalisation, the optimum number of high tension section per 1000 m<sup>3</sup>/m of gas flow rate is around 0.73 to 0.78, the lower value is for higher ESP performance. The performance of ESP improves with degree of high tension sectionalisation due to the following reasons:

- Small sections have less electrode area for sparks to occur.
- Electrode alignment and spacing are more accurate for smaller sections.
- Smaller rectifiers are needed that are more stable under sparking conditions
- Outages of one or two sections have a lesser effect on ESP performance.

#### Migration velocity

The ESP manufacturers determine migration velocity on the basis of individual experience. The important variables that are used to determine migration velocity of fly ash are its resistivity, size distribution, gas velocity distribution, re-entrainment and rapping.

There is a weatherproof gas-tight enclosure over the ESP that houses the high voltage insulators, transformers and rectifiers.

The four steps in ESP process are as follows:

- Place charge on the particle to be collected
- Migrate the particle to the collector
- Neutralise the charge at the collector
- Remove the collected particle.

Resistivity of the dust being caught is usually considered the most important factor affecting the performance of the ESP, the resistivity is only taken into account when dust is caught on the collecting electrode.

Voltage on the DE is raised to some 10,000 volts such that the gas in the space between the DE and the CE is ionised and a current flow takes place between the negatively charged DE and the positively earthed CE. Most dust entering the space between the

DE and CE is bombarded with ions, negatively charged and migrates to the CE. It is at this point that the resistivity of the dust becomes relevant.

With the increase in resistivity, the charges have difficulty in migrating to the earthed CE. This will lead to inhibited ion flow (current) and an overall power input reduction which will also reduce collection efficiency.

In the case, the ESP operates in this condition, it should be able to have a higher treatment time so that it can compensate for the lower power input.

Very high resistivity levels will result in so called 'back ionisation' or 'back corona', where effective power output is highly restricted by a corona discharge taking place in the dust on the CE.

In most of the cases the high dust resistivity is a bigger issue than the low dust resistance, as particles with a high resistivity are unable to release or transfer electrical charge. While passing the collection plate, the particles neither give up very much of their acquired charge nor easily pass the corona current to the grounded collection plates.

High dust resistivity conditions are indicated by low primary and secondary voltages, suppressed secondary currents and high spark rates in all fields. This condition makes it difficult for the T-R controller to function adequately.

Meanwhile, in case of low dust, resistance can cause just as many problems in how the ESP operates. When particles with low resistivity reach the collection plate, they release much of their acquired charge and pass the corona current quite easily to the grounded collection plate. As they lack the attractive and repulsive electrical forces that are usually present at normal dust resistivity levels, they lack the necessary binding forces between the dust and the plate for a satisfactory re-entrainment. ESP performance appears to be very sensitive to contributors of re-entrainment, such as poor rapping or poor gas distribution. [3]

### 3.1 ESP nomenclature

To understand the parts being affected in a retrofit, it is necessary to be familiarized with the names of parts in an ESP.

*Chambers*: refers to a gas tight longitudinal subdivision of the precipitator, whereas the term *fields*: refers to an arrangement of one or more bus sections, oriented perpendicular to the direction of flue gas flow. The parts of the ESP are illustrated in Figure 1.

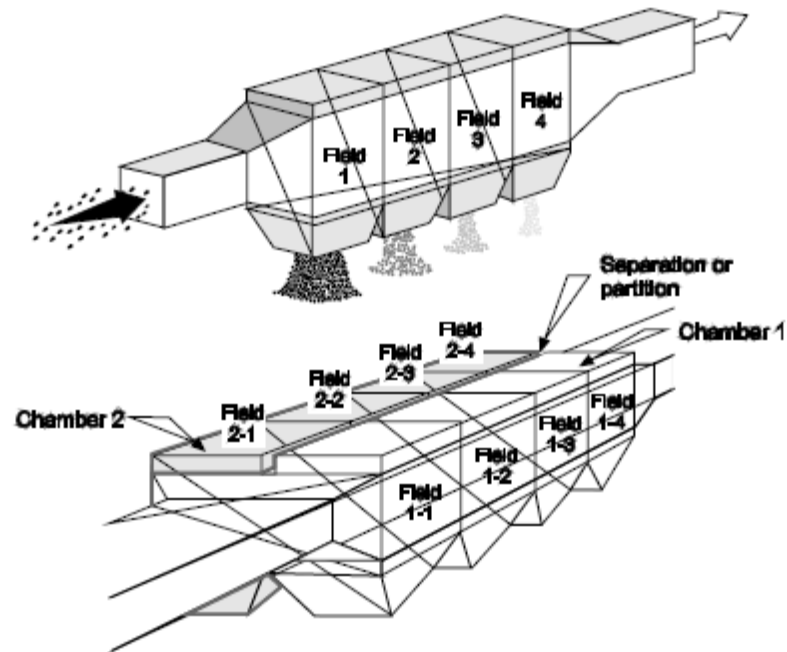

Arrangement of field and chamber in a typical ESP

Figure 1. Typical way of dividing the ESP in functional parts [3]

#### 4 Overview of the fabric filter

Basic explanation of how a fabric filter works and some parameters that affect its performance so to better understand how it would affect the hybrid design are explained below.

In a fabric filter, the dust from the gas stream is cleaned by passing it through a fabric and leaving the dust on the surface of the fabric (Figure 3). This makes the fabric filter unaffected by the dust resistivity, but the same mechanism will make fabric filter vulnerable to contamination.

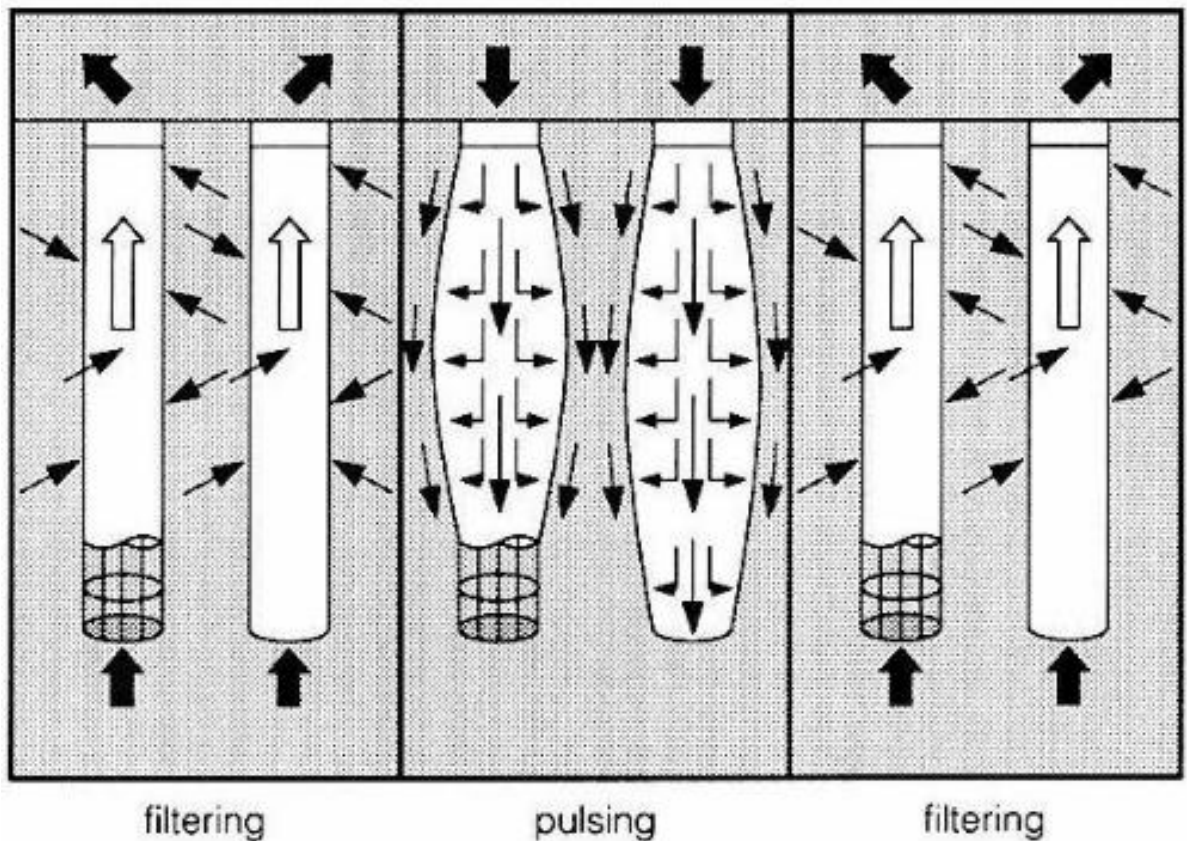

Figure 2. Operation phases of pulse jet fabric filter [5]

Using fabric as a filter media is one reliable method of filtration available it is also an efficient and economic method by which particulate matter can be removed from gaseous streams.

The exact mechanism by which the particles is removed are not fully known but is usually accepted that at least, initial deposition of particles takes place through interception and impingement of the particles on the filter bags because of combined activity due to diffusion, electrostatic attraction and gravity settling.

A fabric filter consists of numerous vertical bags of 120 to 400 mm diameter and 2 to 10 m long, that are suspended with open ends attached to a manifold, the hopper at the bottom serves as a collector for the dust and the gas entering through the inlet duct strikes a baffle plate, which causes the larger particles to fall due to gravity.

The carrier gas then flows to the tubes and then outward through the fabric leaving the particulate matter as a cake on the bag surface. The structure of a fabric filter is presented in Figure 3.

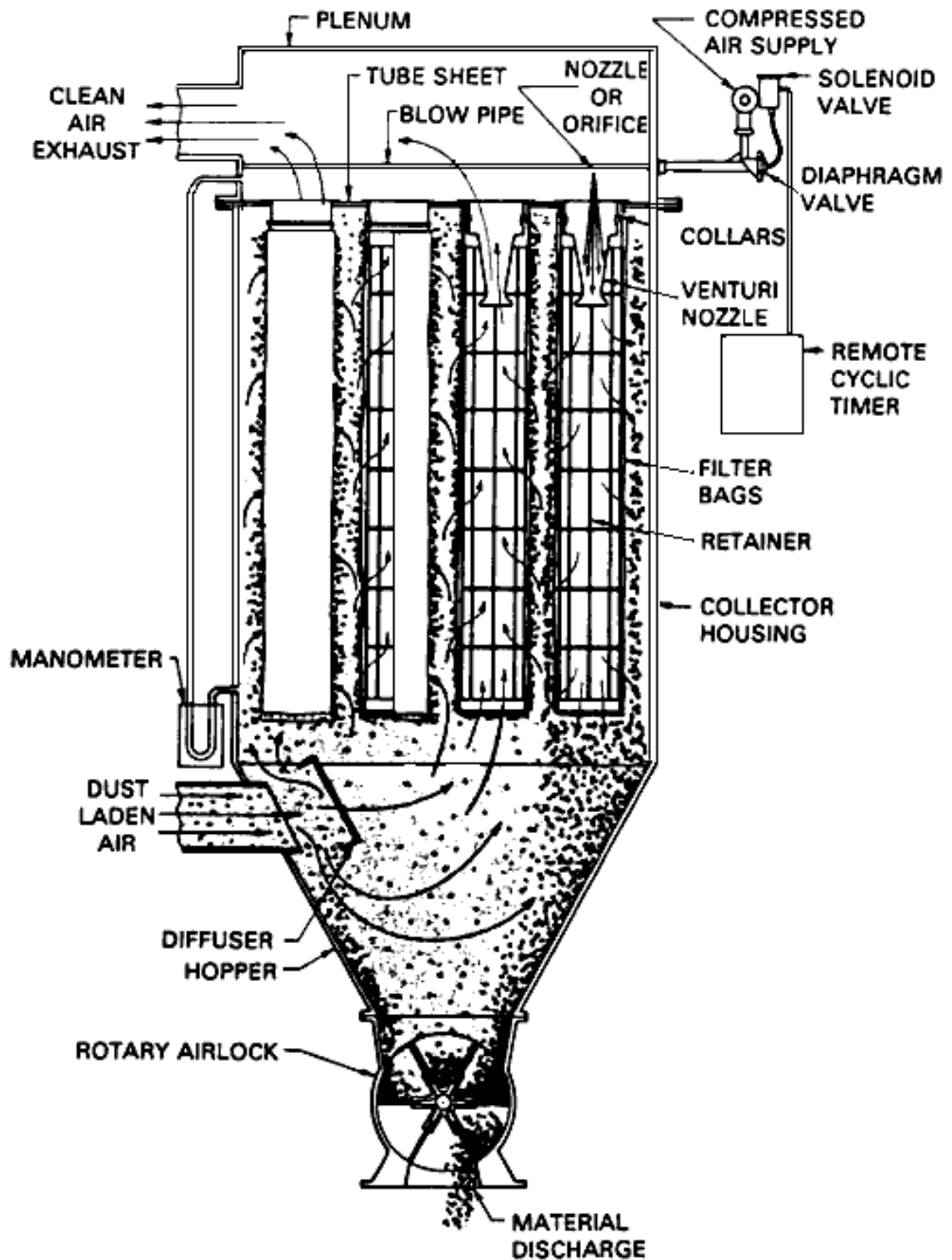

Figure 3. Sketch of a fabric filter [5]

The filter efficiency will increase with time when it is first put online as the dust cake is formed. Once formed, the dust cake will help with capturing particles matter, this will increase the pressure drop and as such it should be periodically removed, this is accomplished with a pulse jet causing the filter cake to be loosened and to fall in the hopper and the normal velocity at which the gas is passed through the bags is 0.4 to 1 m<sup>3</sup>/min. The efficiency of bag filters will be affected by the following main factors:

- *Filter ratio.* Filter ratio is the ratio of carrier gas volume to gross filter area, per minute flow of gas.
- *Filter media.* The filter media should be resistant to chemical attack, temperature and abrasion.
- *Temperature.* The fabric filter will stop working or be damaged if the temperature exceeds the upper limit of the fabric material. Thus, temperature has to be taken into account when selecting the fabric. Temperature problems may also occur if the steam contains reactive gas like SO<sub>2</sub> and SO<sub>3</sub> that will form if the temperature reach below the dew point.
- *Bleeding.* Bleeding is penetration of the fabric by the fine particles and can occur when the weave is too open or if the filter ratio is too high.

The unfiltered dust enters the filter via an entry manifold at the top of the filter dust chamber or in case of a very high dust loading it enter though a separate inlet aisle (in case of an hybrid it enter though the ESP), if the particles that are too heavy to be drawn in to the filter socks to form a dust cake will be deflected into the hopper, otherwise dust cake is dislodged from the bag by periodic pulsing of the filter sock row by row sequence thus maintaining fabric permeability at a level which allow continuous operation this is accomplished by the pulse, a short burst of compressed air, and clean air induced by the sonic nozzle pulse, causes a pressure wave to travel down the filter sock, inflating the fabric and dislodging the dust, at the same time the airflow is momentarily reversed, further assisting dust removal. The design of filters usually includes a high level entry which provides a downward movement in the dust chamber, further assisting to deposit dust in the hopper and avoiding the common problem of loss of efficiency due to re-entrainment. [4]

#### 4.1 ESP and Fabric filter comparison

The possibility for synergy in a hybrid design can be more easily understood when seeing the advantage and disadvantage of each particle control device.



Compared to fabric filter to an ESP it can handle higher temperatures more easily and without the extra cost of high-temperature-resistance fabrics, but this advantage has decrease over time as cheaper alternative fabrics are developed.

An ESP works better than the fabric filter when the gas to be treated and its particles are wet as this will affect the resistivity.

ESPs work without having to force the air through a filter as result the fan energy is lower resulting in the ESP having a low pressure drop.

The capacity to resist unburned material is greater in ESP as in fabric filter the bags may be set alight in contact with incompletely burned particles this is usually a problem in biomass plant than in other process.

The ESP is less sensitive to contamination from the gas stream as it has no barrier nature to its process thus particles that ESP cannot clean just continue with the gas flow. The ESP has a high lifetime expectancy (>15-20 years) without major overhauls compared to the fabric filter, which requires a change of bags at least every 5 years and cages every 15 years. [4]

Fabric filters are useful for collecting particles with resistivity either too low or too high for collection with electrostatic precipitators. Therefore, fabric filters may be good candidates for collecting fly ash from low-sulphur coals or fly ash containing high unburned carbon levels, which respectively have high and low resistivity, and thus are relatively difficult to collect with electrostatic precipitators.

It easier to remove for example SO<sub>x</sub>, HCl, HF, etc. with a Fabric filter than with an ESP When an ESP starts, it does not usually capture oil soot from start-up oil burners, resulting in a temporarily dirty stack. This does not happen with a fabric filter.

The fabric filter has an advantage in achieving stable and high dust collecting performance regardless of kinds of coal. [6]

This consideration should be taken into account when retrofitting as a hybrid filter will share all the negative and positive aspects of both ESP and FF; there can be synergy when an element of the FF helps to deal with particles that an ESP cannot handle.

## 4.2 Design of pulse jet fabric filter

In a conventional fabric filter design, there are parts depending on the application and how much experience a manufacturer have on working with a certain design on them.

Most of solution encountered in conventional filters can be applied to hybrid filter usually with the exception to inlet and outlets for the structure.

This chapter explain some of the most common options for the filter so that this knowledge can be applied in a future design it highlight some of the limitation in each configuration option to give better understanding when retrofitting.

### Roof design

Two common options for the roof design for the fabric filter are presented in Figure 5. The pressure tank on top of the roof inside the casing is the most conservative option. The access to it is more convenient, and it is easier to protect the part of the header tank from the temperature and elements in the fabric filter.

The other option is having the pressure tanks built hanging outside in the roof with a service platform for maintenance. The difficulty in this arrangement is the necessity to make a hole in the existing casing, but it creates more area for the bags in the filter and saves height if this is a concern in the project.

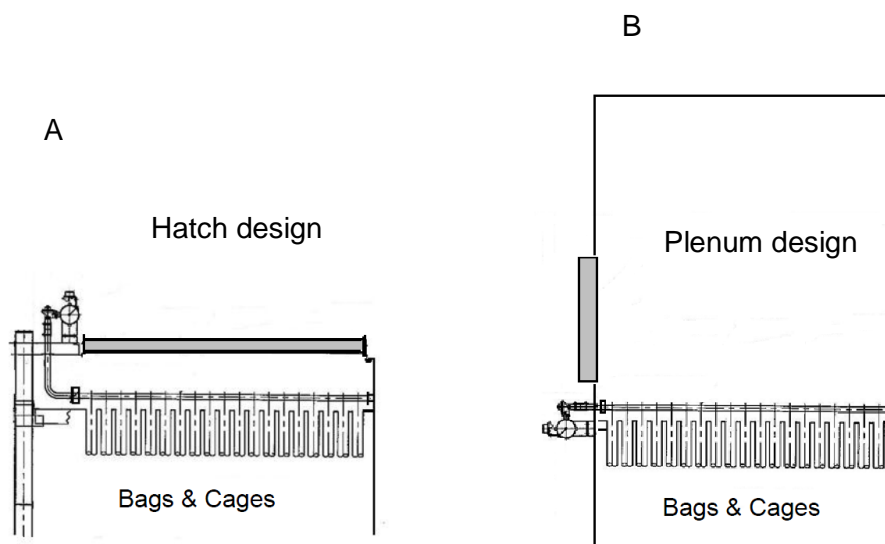



Figure 4. Design sketch of pulse jet roof: (A) hatch design and (B) plenum design.

The usual configuration of fabric filter for different bag length.

### Long Bag PJFF

Side entry with gas/dust distribution

Down flow in bag zone

Split into compartments

Designed for use of long bags (6-10 m)

Used in power boilers, mineral industry, waste incineration, ESP conversions etc.

HPLV (High Pressure Low Volume) or IPIV (Medium Pressure Medium Volume) cleaning

### Short Bag PJFF

Bottom entry to compartments

Up flow in bag zone

Split into compartments

Designed for use of bags up to approx. 4.5 – 6.0 m long

Used in the mineral industry, waste incineration etc.

HPLV or IPIV or LPHV (Low Pressure High Volume) cleaning

In Figure 5 is presented the pulsing arrangement of the solenoid valves its specification are below the figure.

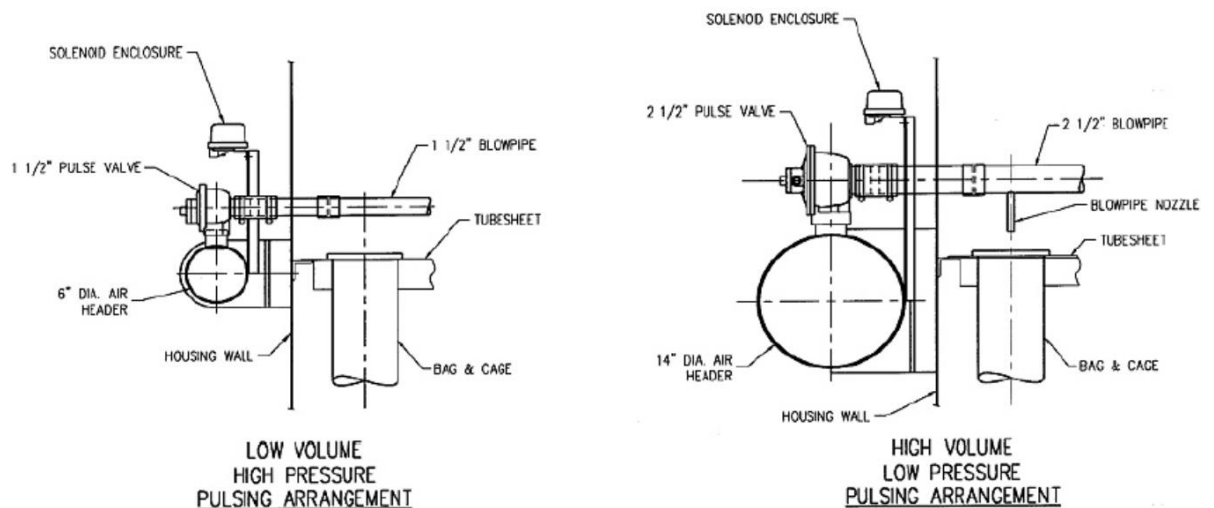

Figure 5. Tank arrangement [7]

### Three types of cleaning systems typical configurations

There are three types cleaning systems available. Their typical configurations are presented below:

#### Low Pressure/High Volume

- 1 bar
- Round collectors with rotary arm cleaning system
- Oval filters common also round with cages

- No venturis
- Filters: 125-159mm x 3000-6000mm 5"-6.25" x 10'-20'
- Utilizes positive displacement blower

Use of fan to deliver high volume of air at low pressure.

#### High Pressure / Low Volume Pulsing

##### Standard pulsing system

- 8-7bar
- Typical 6" diameter compressed air header
- 1 ½" diameter pulse valve & blowpipe
- 1 ½" dia. pulse valve at 90 psi =620 kPa uses 45 scfm=0.02 m<sup>3</sup> / s max.
- pulse interval: 6 sec duration: 100ms/pulse volume: 4.5 scfm/pulse =0.02 m<sup>3</sup>/s
- power required to compress air to 90 psi= 620 kPa 9.85 Hp = 7.35 Kwh

Cleaning air supplied by "house" compressed air system and oil and moisture contamination from "house" compressed air system are common.

#### Medium Pressure / High Volume Pulsing

##### Standard pulsing system

- 2-3bar (30-45psi)
- 14" nominal diameter compressed air header
- 2 ½" diameter pulse valve & blowpipe
- Blowpipe requires nozzle extensions at each blow hole
- 2 ½" diameter pulse valve @ 30 psi consumes 140 scfm max.
- pulse interval: 6 seconds duration: 230msvolume: 14.03 scfm/pulse =0.0067m<sup>3</sup>/s
- Horsepower required to compress air to 30 psi=2 bar: 15.26 Hp = 11.38 Kwh

Use of positive displacement blower to supply air. Air supply is local to inlet of PD blower and oil and moisture contamination not typically a problem. [7]

### 4.3 Header tank

Header tanks are typically manufactured with the valves already in the tank; there are two options: a round tank (more common) and a square tank. The round tank can have either a flat end or a round end. The form of the tank does not affect its performance in a significant way; only its volume has an effect. The material options for the tank are carbon steel, stainless steel and aluminium (to operate in corrosive environments).

The size of the tank should be kept in mind when designing the roof of the project.

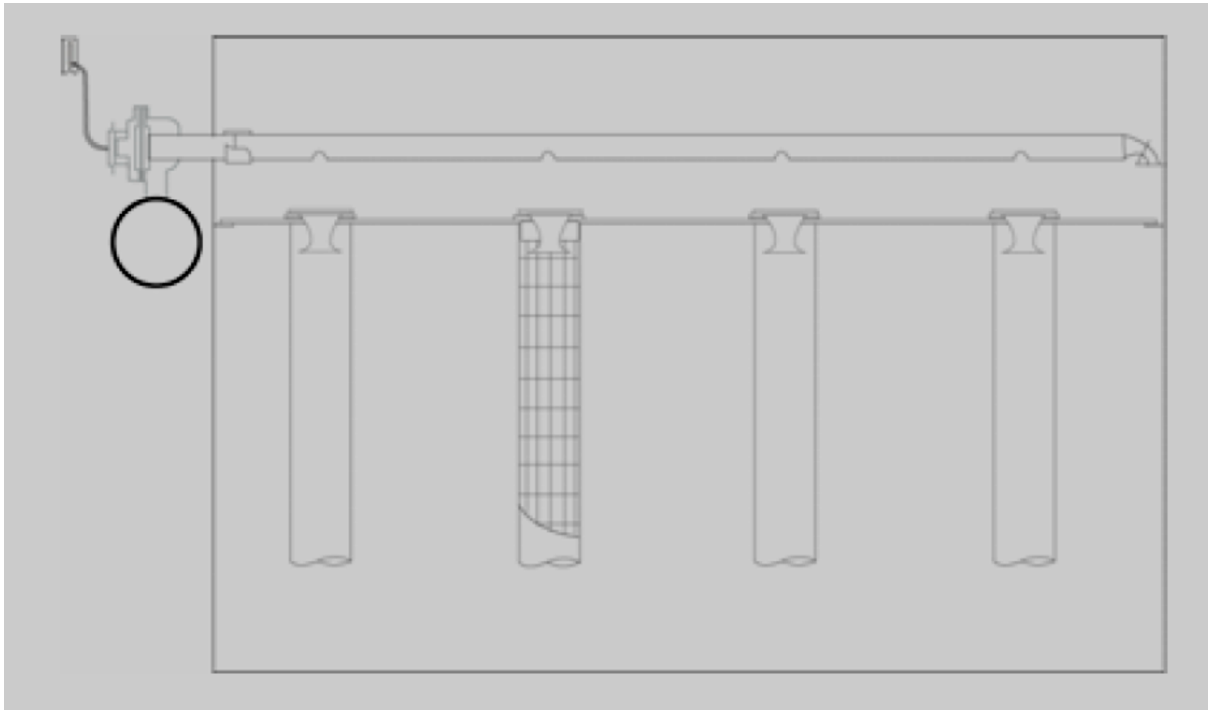

Figure 6. Header tank highlighted [8]

The quality of the compressed air being feed to the header tank should be as follows:

- Water content: max 10 g/Nm<sup>3</sup>
- Oil content: max 0.02 g/Nm<sup>3</sup>
- Over pressure: 350 kPa

Maximum and minimum sizes of the of the header tank valves that can be accepted in the tank with the typical size of the valves are given in table 2.

Table 2. Typical size of the valves

| Tank Diameter          | Valves Accepted           | Manufactures              |
|------------------------|---------------------------|---------------------------|
| 4" (114.3 mm) 9.2 l/m  | 1/2" Valves               | Autel,Turbo               |
| 5" (139.7 mm) 14 l/m   | 3/4" VALVES               | Autel,Mecair,Turbo        |
| 6" (168.3 mm) 20.7 l/m | 1" Valves                 | Autel,Trimec,Mecair,Turbo |
| 8" (219.1 mm) 35 l/m   | 1"1/2 Valves<br>2" Valves | Autel,Trimec,Mecair,Turbo |
| 10" (273 mm) 54.3 l/m  | 2" Valves                 | Autel,Trimec,Mecair,Turbo |

|  |   |                                     |
|--|---|-------------------------------------|
| <b>12" (329.9 mm) 78.3 l/m</b>         | <b>2"1/2 Valves<br/>3" Valves</b>               | <b>Autel, Trimec, Mecair, Turbo</b> |
| <b>14" (355.6mm) 91.3 litre/ meter</b> | <b>3" Valves<br/>3"1/2 Valves<br/>4" Valves</b> | <b>Trimec</b>                       |

Figure 7 illustrates the typical measurements of the header tank and table 3 gives possible measurements for the tank.

Figure 7. Typical Measurements in a tank

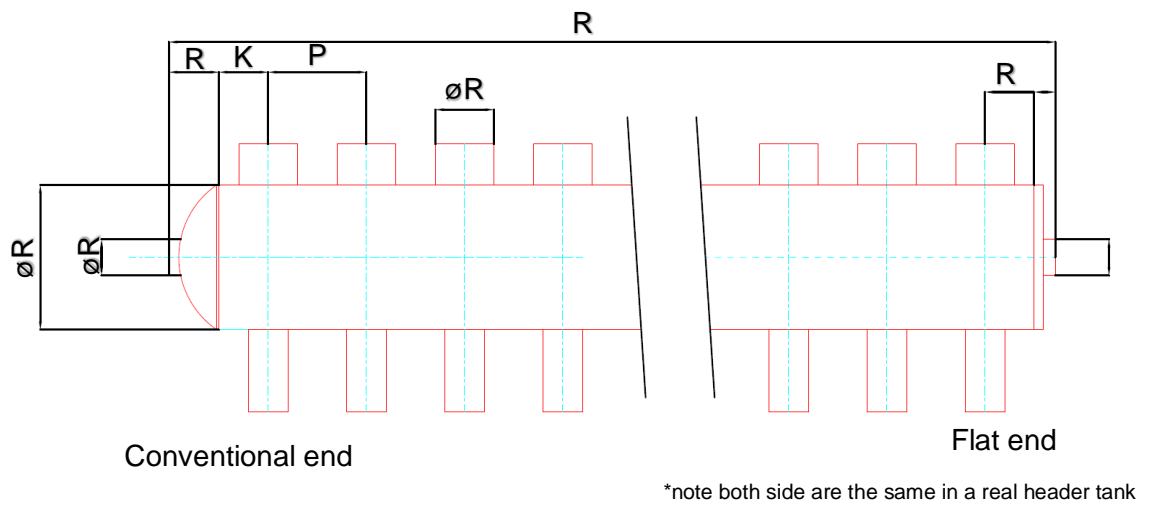

Table 3. Drawing representing a header tank typical measures with one side flat end other side a conventional end.

| <b>Valves</b>           | <b>P minimum<br/>mm</b> | <b>B minimum<br/>mm</b> |
|-------------------------|-------------------------|-------------------------|
| <b>1/2" Valves</b>      | <b>102</b>              | <b>55</b>               |
| <b>3/4"<br/>VALVES</b>  | <b>120</b>              | <b>90</b>               |
| <b>1" Valves</b>        | <b>120</b>              | <b>90</b>               |
| <b>1"1/2<br/>Valves</b> | <b>120</b>              | <b>90</b>               |

|                     |            |            |
|---------------------|------------|------------|
| <b>2" Valves</b>    | <b>185</b> | <b>115</b> |
| <b>2"1/2 Valves</b> | <b>185</b> | <b>110</b> |
| <b>3" Valves</b>    | <b>215</b> | <b>125</b> |
| <b>3"1/2 Valves</b> |            |            |
| <b>4" Valves</b>    |            |            |

### Supplier of Header tanks

Autel, Trimec, Turbo and Mecair has provided many solutions for header tanks. Both of them offer valves, header tank and control systems

#### 4.4 Pulse valve

The pulse of compressed air is controlled by series of pulse solenoid valves that are placed on the air reservoir. These in turn are connected to a compartment manifold pipe, which open above the venture of each bag in that row (Figure 8).

The diaphragm of the pulse valve is closed as the compressed air is trapped between diaphragm and solenoid valve orifice.

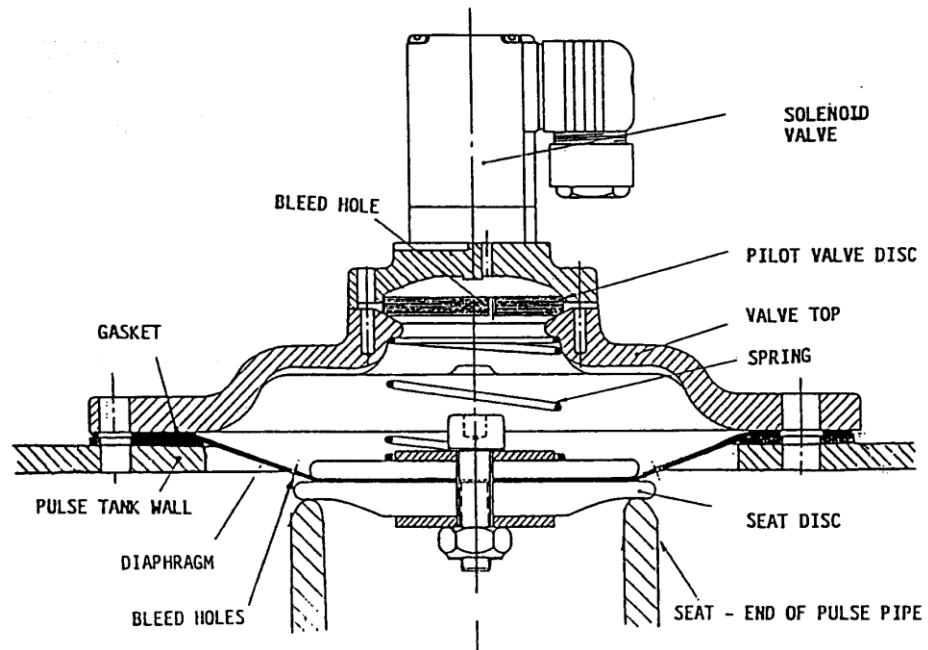

Figure 8. Sketch of valve with names of the parts[7]

When the solenoid valve is energized through an input signal from the sequential controller, the trapped air flows from the top of the diaphragm through the orifice of the solenoid valve. Then the inflowing compressed air lifts up the diaphragm and flows through the outlet of the pulse valve. Afterward when the solenoid valve is de-energized, the air gets trapped, closing the diaphragm as a result of pressure equalization. After next solenoid valve gets energized and the entire process is repeated sequentially in cycle until the desired pressure drop is achieved.

#### 4.5 Blowpipe

The size of the holes in the blowpipe varies accordingly to the how close they are to the valve; the closer they are, the larger they happen to be (Figure 9).

This is usually is determined by experience of either the manufacturer of the fabric filter or the manufacturer of the header tank.

The blowpipe should be designed in such a manner that it can be handled without using any tools.

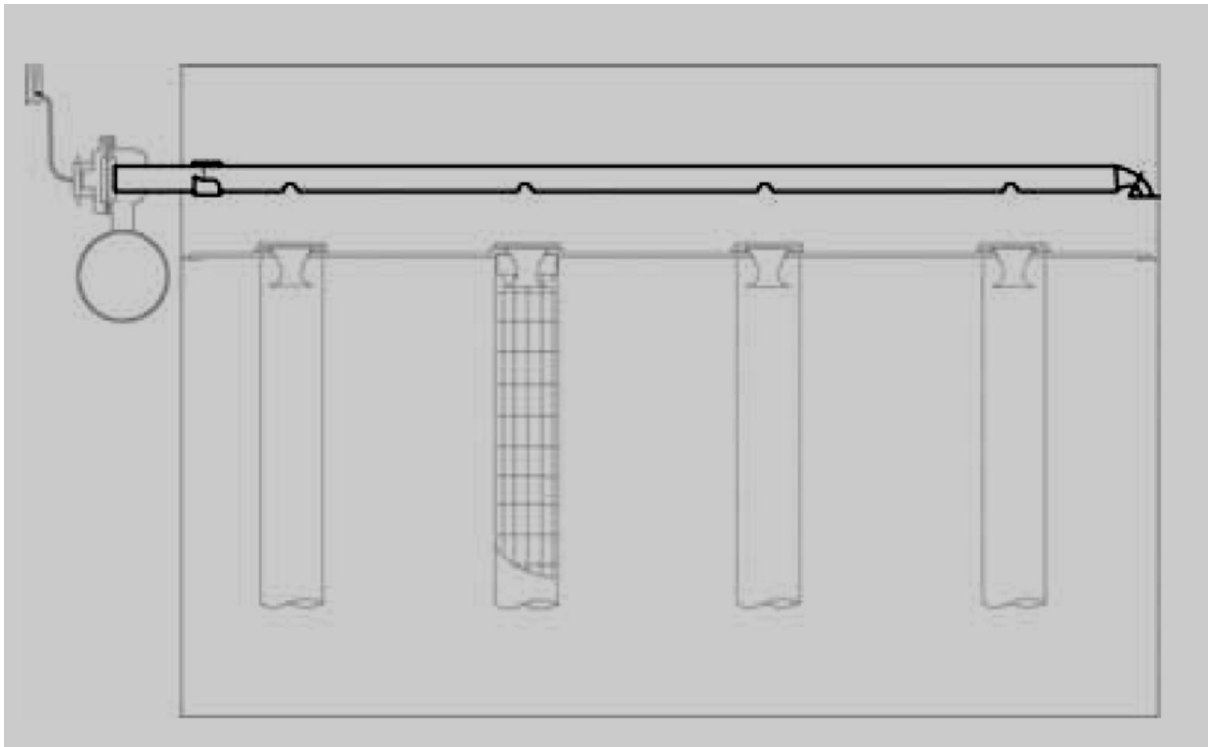

Figure 9. Fabric filter with blowpipe highlighted [8]

Maximum tolerance for misalignment is 6.35mm, above that the pulse will not have a significant effect on the bag (Figure 10). The smaller, the less the misalignment is the better the ventures can help in alleviating the problem.

## Blowpipe misalignment

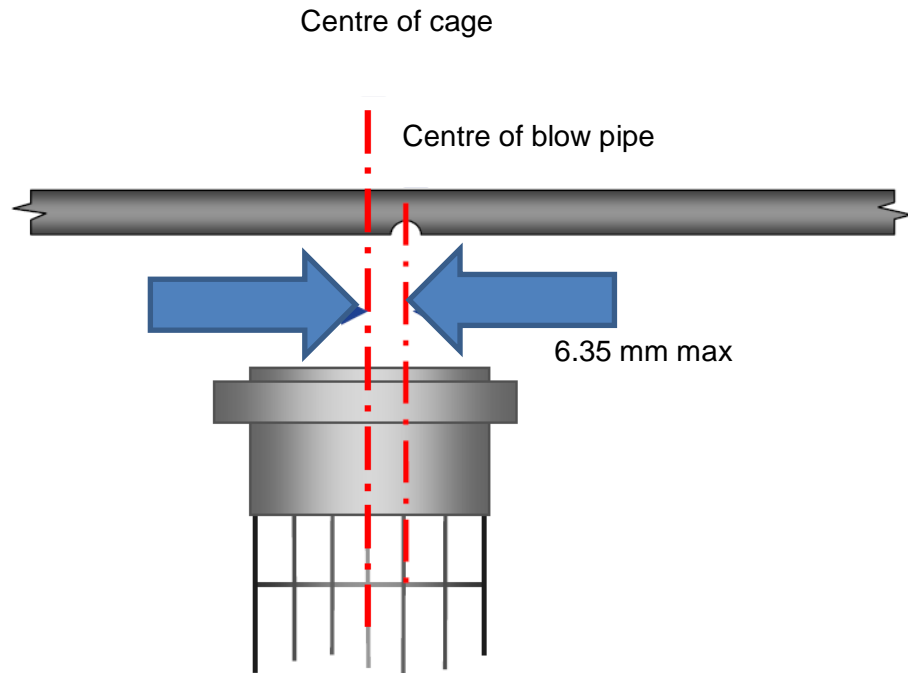

Figure 10. Blowpipe misalignment [8]

The blowpipes allow the air from the header tank to be moved to the bags.

Example of blowpipes for specific configurations of pressure are shown in figures 11-13 in the images below; they give an idea of the proportions that blowpipe have in fabric filters.

Low pressure configuration has a much larger manifold than other configurations.

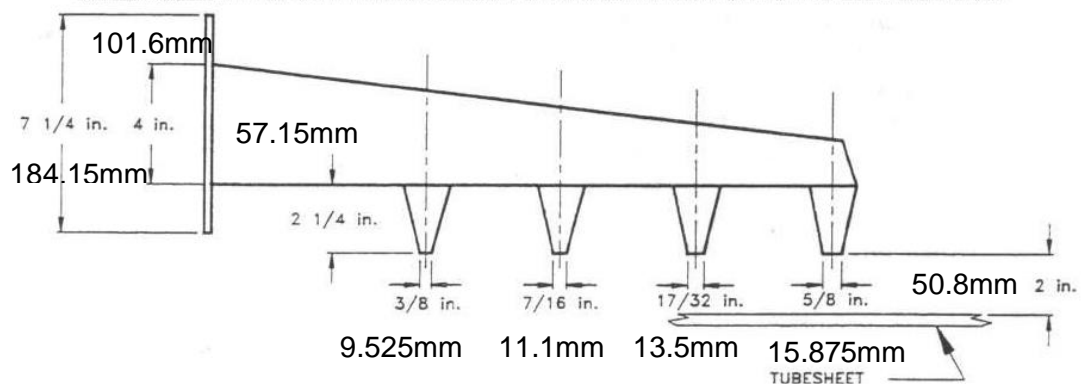



Figure 11. Low pressure blowpipe with metric unit added [10]

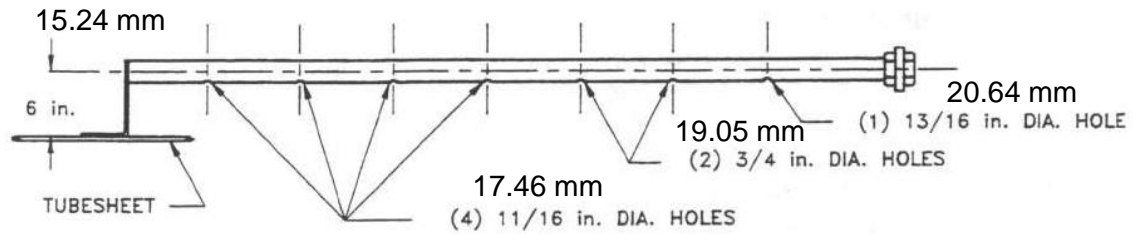

Figure 12. High-pressure blowpipe with metric units [10]

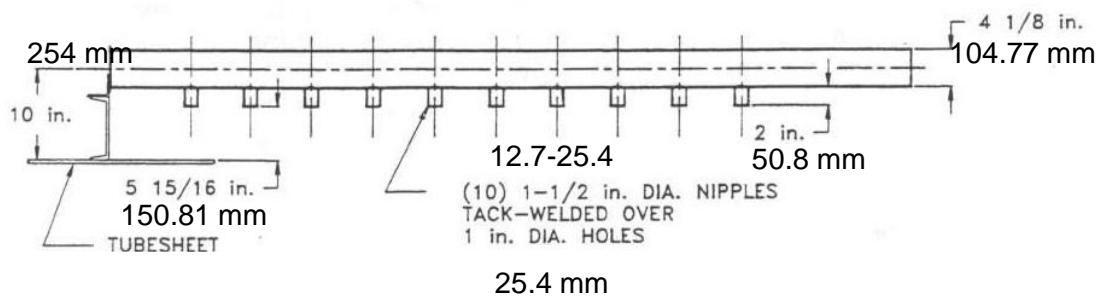

Figure 13. Medium-pressure blowpipe with metric units [10]

#### 4.6 Venture

This device is usually installed on top of the filter cage parallel to the blowpipe so that the direction of the pulse is concentrated on the bags of the fabric filter (Figure 14).

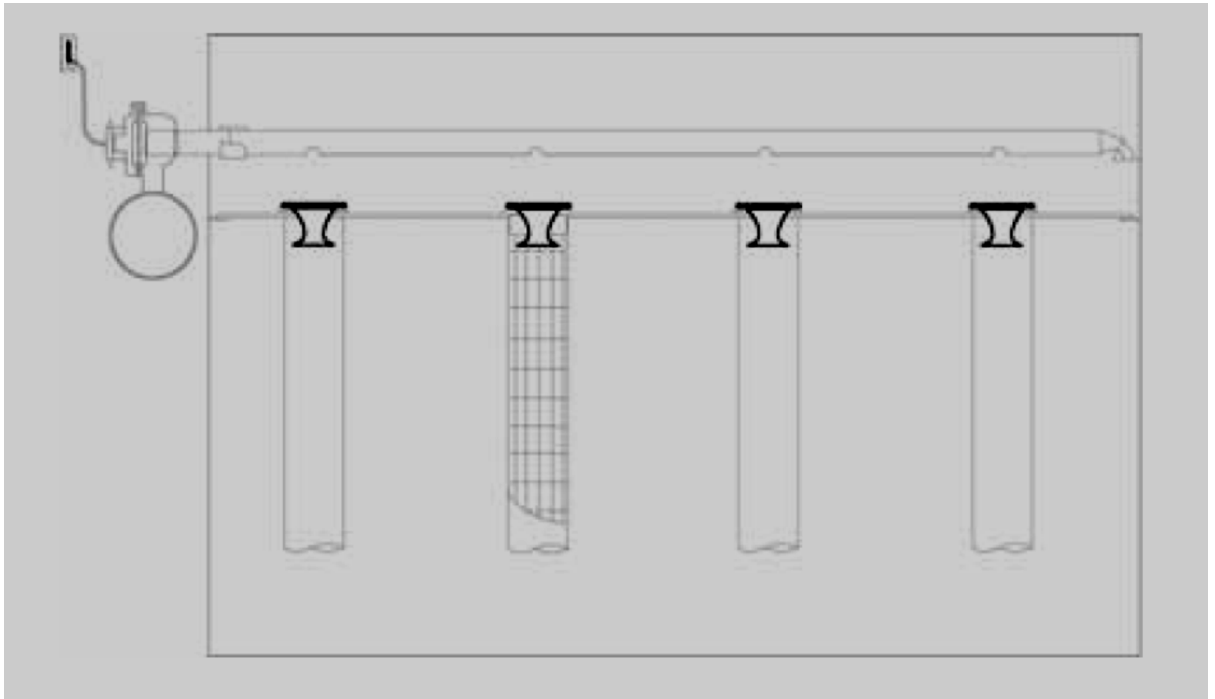

Figure 14. Fabric filter with ventures highlighted [8]

A venture is an integral component of some pulse-jet collectors. It directs the blast of compressed air into the centre of the filter bag to prevent abrasion caused by misaligned blowpipes and turbulent airflows. If ventures become damaged or worn, compressed air does not gain the velocity required to effectively clean the filter bags.

In the Figure 15. Different types of diffusers [11]. Diffuser nozzle (A), Laval nozzle (B).

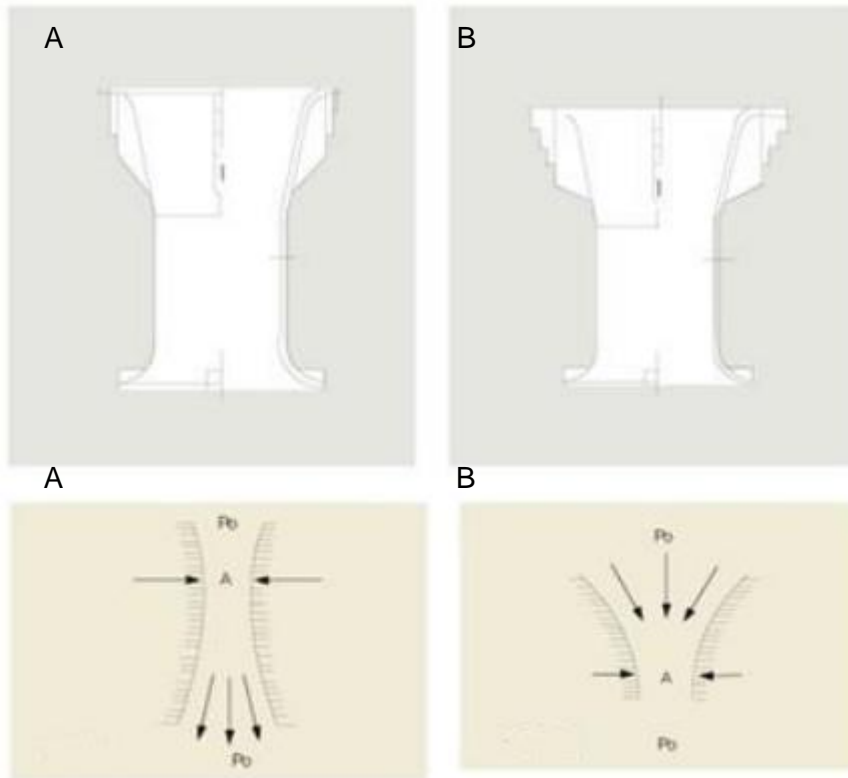

Figure 15. Different type of diffuser [11]

Diffuser nozzle: It converts pressure energy of fluid to speed energy, while the Laval nozzle converts pressure energy to speed energy (Figure 15A and 15B).

There is also an option of going venturi free design [11], this is more common in low pressure configuration [10]

#### 4.7 Bag cages

Cages provide the support for the bag and are exposed to the element that are being cleaned and to the weight of the fabric and dust (Figure 16).

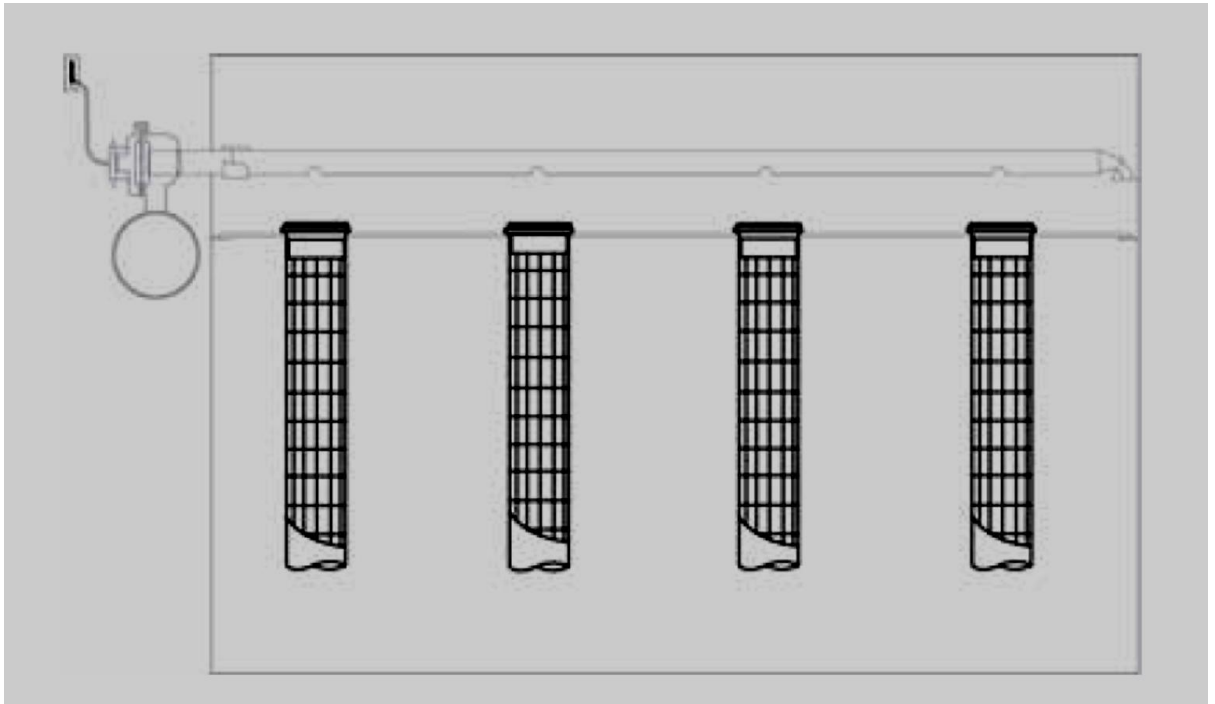

Figure 16. Fabric filter with bag cages highlighted [8]

Proper support of filter bags is critical for efficient cleaning and long bag life as over time, cages become corroded, which can cause wear and premature bag failure.

Filter cages are typically made of mild steel, galvanized steel, epoxy coated or stainless steel. If designing for a corrosive environment, multiple piece cages can be provided with dissimilar metals at the connecting point.

A steel wire cage is required to support the fabric of the filter bag. The cage is designed to support the fabric evenly and restrict flexing and abrasion of the filter bag while allowing optimum dust release at the time of cleaning.

Cages are like a wire frame placed inside pulse jet filter elements to provide support to the fabric as flexing occurs during filtration and cleaning cycles. Configuration of a frame generally follows the shape of the filter elements, i.e., circular, oval, flat or star shaped. Cages for long filter elements are made in sections which snap together for easier handling. Wear points on filter bags may develop at the horizontal supports.

The rigid wire design offers maximum durability and support for pulse jet bag houses.

The typical filter configuration for a top load unit is snap band top (*double-beaded ring*) with disk bottom (w/o wear strip), while the typical filter configuration for a bottom load unit is *raw end top* with *disk bottom* (w/o wear strip)

### **Some other options**

Ground Wires – Use to comply with Factory Mutual requirements for static dissipation. Ground wire can be made of stainless steel or copper however this technique only works on a localized area of the filter. For optimal static dissipation look at conductive fibre filter made with Eptropic or stainless steel fibres.

Wear Cuffs – Used to combat abrasion at the bottom of the bag either from a sandblasting effect or from bag-to-bag abrasion due to turbulence in the bag house. Wear cuffs are usually 5 to 10 cm (2 to 4 inches) in length and made of a material similar to that of the body of the filter bag.

### **Material**

Little consideration is usually given to cage material. Cages are commonly made of galvanized carbon steel wire. As any wire cage that fulfils that function is usually acceptable. Sometimes, where special materials dictate, a 20-wire cage may be necessary to limit flexing and associated fatigue failure of the felt. Stainless steel wire is used where a chemical attack is anticipated.

The available materials are listed below:

- Carbon Steel
- Galvanized Steel
- Epoxy Coated
- Stainless Steel construction

### **Type of cages**

#### **Round**

Round cage is the most common type of bag cage in pulse jet fabric filter it possible to find 10 m long round cages but conservative fabric filters usually have less than 6 m long cages the diameter is usually 13 cm, larger than that is not recommended.

There are many options for top and bottom parts, which are presented in Figure 17.

### Top part different options

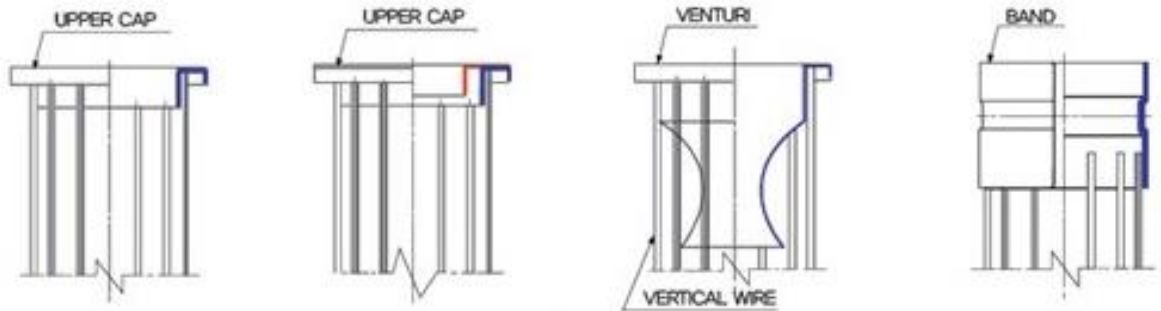

### Bottom part different options

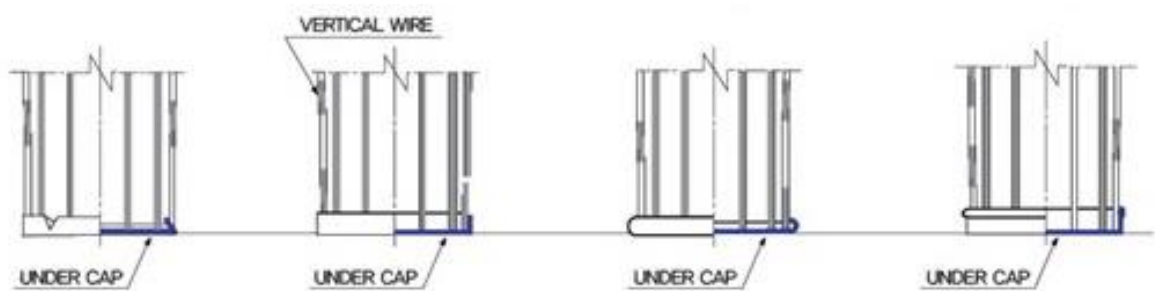

Figure 17. Different option for cages top and bottom  
Number of wires in standard construction options

Low pressure configurations usually have a 14 wire configurations but an 8-wire configuration has also been used in the medium and high configuration can be found with 8 to 20 configuration. As fewer wires are usually expected to provide a better fabric movement during the pulse; this should cause more dust to be dislodged of the fabric, which is usually considered a positive outcome. [10] Figure 18 illustrates the arrangement of the wires in the bag cage.

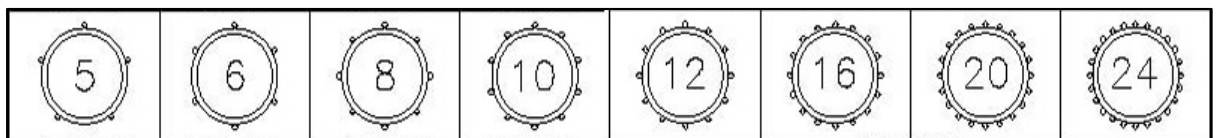

Figure 18. Illustration of the arrangement of the wires in the bag cage

The recommended minimum specification for cages depends on the fabric in the cage construction. Sometimes the gas condition should be taken in to account.

For standard needle felts, the specifications are as follows:

Vertical wires maximum spacing (Equally spaced, straight and parallel) = 38.1 mm

Horizontal rings maximum spacing = 203.2 mm

Vertical wire diameter = 2.38 to 3.175 mm

Horizontal ring wire diameter = 3.175 to 4 mm

For PTFE felt, woven PTFE and woven glass, the specifications are as follows:

Vertical wires maximum spacing (Equally spaced, straight and parallel) = 19.05mm (3/4 inch)

Horizontal rings maximum spacing = 152.4mm (6 inches)

Vertical wire diameter = 3.175 mm to 3.9 mm (1/8 to 5/32 inch)

Horizontal ring wire diameter = 3.9 mm (5/32 inch)

### Oval

In the oval design, fabric filters are found in circular arrangement and usually work with low pressure.

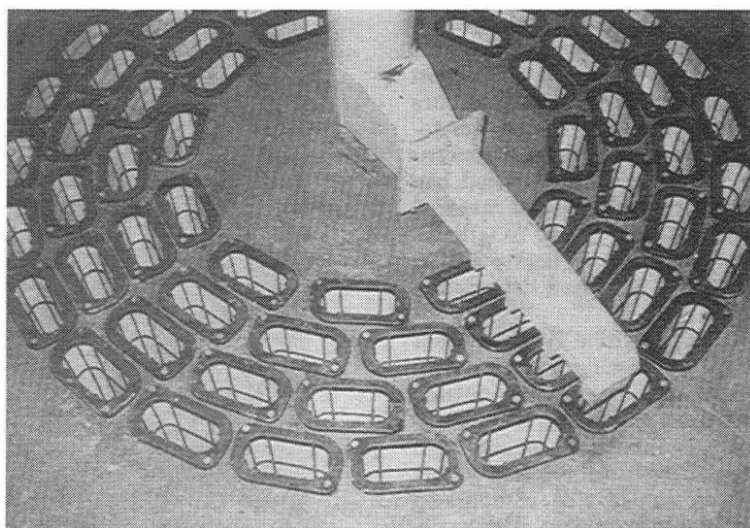

Figure 19. Oval configuration example[10]

### Star

Star-Bag and Star Cage designs were developed to provide the end user with an opportunity to increase available fabric filtering area within the same given footprint occupied by traditional cylindrical and oval filter bags. The Star-Bag™ is designed to offer filter surface areas that are from 1.7 to 2.4 times larger traditional filter surface areas. They are operated with pleated bags.

This additional area is obtained by sewing the filter bag in a pleated configuration. The pleats are gathered at the top snap band so that the bag may fit in the same cell plate hole as the standard bag of the same top diameter. The pleats are retained during pulse cleaning cycles by a series of horizontal bands sewn to the fabric.

The star-cage can usually be retrofitted in a fabric filter using the conventional round cages without any major problems. This is usually done if the fabric filter does not work and there is suspicion that increasing the filtration area would help.

Special bag shapes reduce air to cloth ratio for a given number of bags. However, this will be of no benefit if the bag house performance is limited by can velocity, as is often the case. One should always keep in mind that there is no bag shape that permits the violation of the fundamental principles of bag house design.

Control of air to cloth ratio and can velocity are necessary with all bag shapes.

### Type of connections

The connection between cage pieces must be designed to withstand the rigors of installation and everyday operation without becoming a maintenance burden and at the same time not becoming a weak spot in the cage (Figure 20).

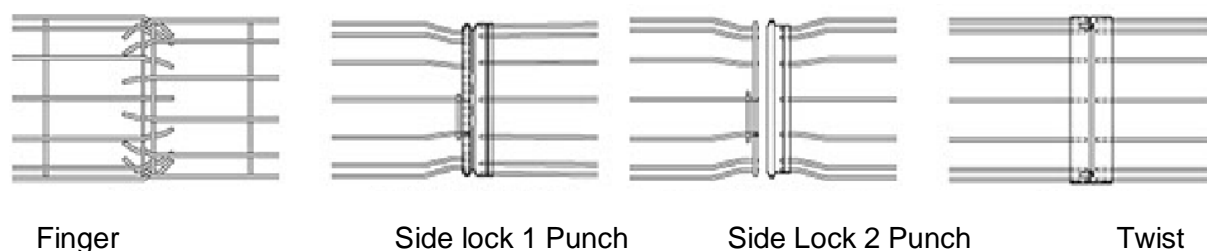

Figure 20. Lock in bag cages

Besides the type of cages, there is the question of spacing the bags. There are options of uniform spacing with the same bag a 50mm spacing is recommended. This is the best option and the most common solution.

Too small spacing will result in the bags entering in contact with each other and collapsing or destroyed fabric. If necessary, there are other methods of grid spacing with two



rows of bags of different size to maximize the filtration area. This is only used when it absolute necessary.

It is also necessary to consider the ratio between the filter bag and bag cage usually called 'slack'. A larger slack gives usually a better cleaning effect from the pulse but will negatively affect the life span of the bag due to mechanical wearing of the filter fabric. The rule of thumb is to keep the ratio between 4 to 5 %.

### **Cartridge option**

Further increases in filter area per unit of fabric filter volume are obtained by using finely pleated filter media supported on a wire framework. This cartridge can be mounted vertically as a nearly direct replacement for standard bags and cages in existing fabric filter, or mounted horizontally in original designs.

When used as a direct replacement for standard bags and cages, the retrofit costs for one case are 70 % of the cost of building a new fabric filter. Cleaning of early cartridge fabric filter designs is by typical pulse equipment using a blow pipe across a row of cartridges.

#### **4.8 Tube sheet**

The connection between the filter bag and tube sheet is critical to both environmental performance and bag life. The integrity of this connection depends on tight tolerances for the bag, cage and tube sheet hole. Corrosive flue gas will affect the tube sheet and, over time, the whole diameter tolerance will be lost.

It is usually necessary to install a support beam as any bend in the tube sheet will possibly make the bags to collide with each other, which will result in them being damaged or the pulse will now damaging the bags.

#### **4.9 Fabric options**

For proper filtration, it is necessary to have a fabric that can resist the element in the filter and the heat, abrasion and chemical attacks caused by the element.

Figure 24 illustrates a fabric filter with bags. The following subsections briefly present the common fabrics used and their properties.

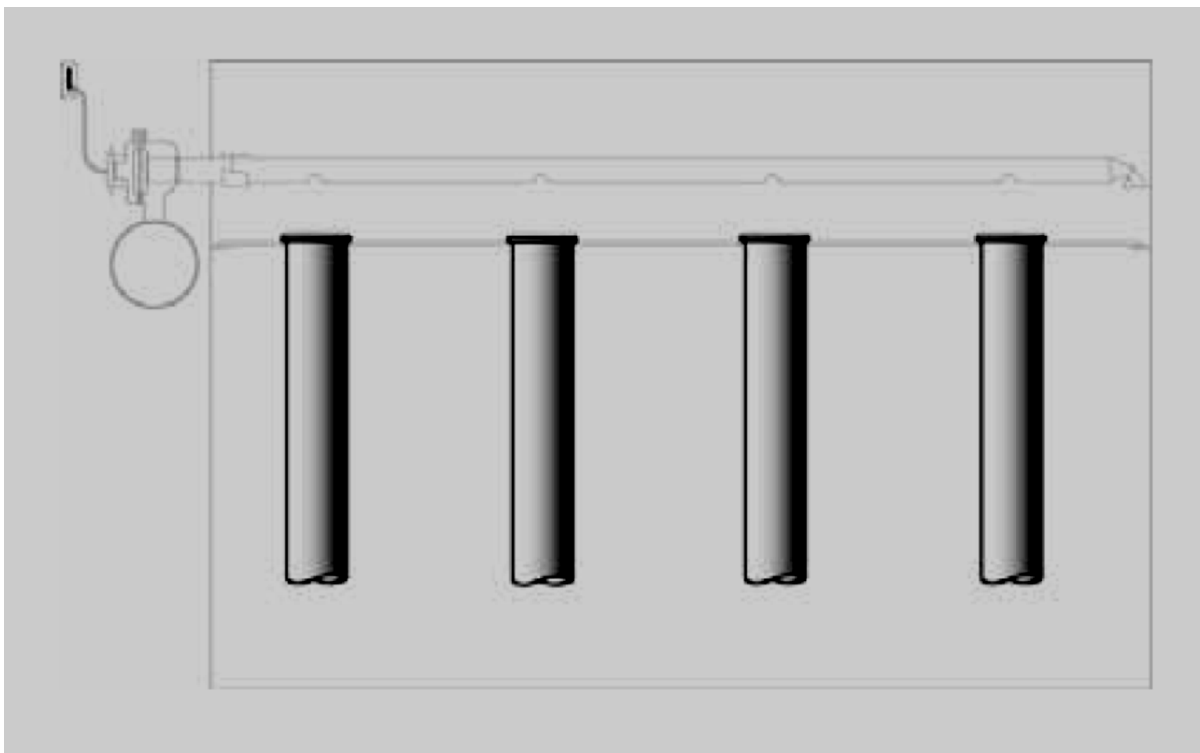

Figure 21. Fabric filter with bags highlighted [8]

#### 4.9.1 Fibreglass.

Fibreglass is relatively inexpensive compared to other fibres, its maximum operating temperature of the fibre is 260°C, which offers potential for use in a large cross section of power station and coal types.

However, its low flex abrasion and low resistance to mechanical damage limits the use of fibreglass in fabric structures that involve lower stresses during production and use. Therefore, almost all of the fibreglass produced for filter end uses is manufactured into woven fabrics. This limits its expansion into other filtration areas requiring other fabric constructions.

To help the fibreglass fabrics withstand some of the mechanical stresses and to increase their chemical resistance, it is commonly treated with a Teflon, silicon or graphite finish. Generally, fibreglass felt is made of 350–900g/m<sup>2</sup> and has a high filtration efficiency. And since it is a woven fabric, it should be used with pulse air under 4kg/cm<sup>2</sup>, and with a small interval between the wire and the ring. [9]

#### 4.9.2 Homopolymer Acrylic (PAN)

The mechanical properties of the homopolymer acrylic (PAN) allows it to be used for varied fabric constructions. It has relatively good textile fibre properties, which allow it to be spun economically into yarns for the production of woven fabrics. Its mechanical properties also allow it to be used for the production of needled fabrics the chemical resistance properties of the fibre make it ideal for the use in the collection of fly ash, particularly for coals with lower sulphur content.

There are, however, several drawbacks, with PAN fibre, which has means that the usage of the fibre has slowly decreased over recent years.

PAN's maximum long term operating temperature is 135°C. This means that for the efficient low term life of the bag, at temperature, usually by the induction of ambient air, is required to maintain the gas stream below this temperature. This increase in air volume means that a larger fabric filter with increased cloth area is required for efficient filtration performance.

The lower gas temperature can also mean that there is an increased possibly of the fabric experiencing acid dew point excursions. This can degrade the fabric and is an important point to consider especially as coals with higher sulphur contents are being used.

The fibre has an inherent shrinkage problem that becomes evident over longer operating life. This fibre shrinkage cannot be eliminated completely by heat setting treatment of the fabric. [9]

#### 4.9.3 Polyphenylene Sulfar (PPS)

The use of polyphenylene sulfar (PPS) became popular in the 1980's as it became commercially available.

The PPS fibre has an advantage over PAN fibre because of its increased thermal resistance. It can operate at a constant 190°C. This means that the majority of fabric filters can operate without flue gas stream air at temperature. The PPS fabric filter can, therefore, be smaller in size compared to one using PAN fibre. This is an important factor when retrofitting a fabric filter into an Electrostatic Precipitator casing.

At higher operating temperatures there is less chance of the PPS fabric operating near or below the acid dew point. The PPS fibre is also less susceptible to shrinkage than PAN, with fabric shrinkage being mostly eliminated by effective heat setting.

The fibre is much more expensive than PAN fibre, but it can be cost-effective over the life of the boiler because of longer filter bag life expectancy and less fabric surface area required for a given boiler output.

The fibre can be affected by high levels of NO<sub>x</sub> in the gas stream. Likewise, the presence of bromides in the gas stream can have an adverse effect on the life of the filter bags.

Almost all new and retrofit fabric filters today are using PPS fibre. There is also a trend for fabric filters originally fitted with fabric produced using PAN fibre being converted to fabrics using PPS fibre. [9]

#### 4.9.4 Polyimide (P84)

The polyimide (P84) fibre has a maximum operating temperature of 260°C.

The fibre has not found widespread use in flue gas filtration in utility power stations for several reasons:

- The fibre is very expensive.
- The fibre is susceptible to acid hydrolysis.
- P84 fibre is used in a small number of industrial boilers where the high boiler outlet temperatures limit the use of other fibres.

The fibre has also found a limited use in some power stations where the capture of fine ash particles is required to meet the emission standards. The P84 fibre has a trigonal shape which has been proven to give improved small dust particle retention due to the fibres increased surface area.

The P84 fibre is used as a fine layer on the filtration side of a standard PPS or PAN fabric. [9]

#### 4.9.5 Polytetrafluoroethylene (PTFE)

The maximum operating temperature of the polytetrafluoroethylene (PTFE) fabric is 260°C. The fibre has excellent chemical resistance to most chemicals.

However, very few fabric filters in the power generation industry have been fitted with this fabric for the following reasons:

First, the fabric is extremely expensive. The cost of the fabric means that it is used only in conditions that are highly caustic or acidic and operating at high temperatures.

Secondly, the fibre is very smooth and a poor textile fibre. This means that the fabric is hard and expensive to produce. It also means that the fabric is very hard to stabilise in fabric finishing. There can be problems with stretching and/or shrinking during filtration operation.

This characteristic is due to the low fibre-to-fibre surface friction, which also assists its dust release capabilities.

Thirdly, the fibre/fabric is a poor filtration fabric. The fibres are very smooth meaning that ash particles are not easily collected. Higher emission levels are expected with this fabric. The low surface friction due to the "non-stick" characteristic of the PTFE, allow the dust particles to continue to "work through" the filter media. [12]

### Summary of the properties of the fabrics

The fabric have to be selected based on their properties and how it behave with the dust and gas properties. Table 4 presents an evaluation of the properties of the fabric on a scale from 1 (*worst resistance*) to 5 (*best resistance*).

Table 4. Above table with properties of fabrics 5 best resistance 1 worse resistance[12]

| Fibre | Common name   | Continues (C) | Peak (C) | Acid | Alkali | Hydrolysis | Oxidation | Abrasion | Relative price |
|-------|---------------|---------------|----------|------|--------|------------|-----------|----------|----------------|
| PP    | Polypropylene | 90            | 95       | 5    | 5      | 5          | 3         | 5        | 1              |
| PES   | polyester     | 135           | 150      | 4    | 2      | 1          | 5         | 5        | 1              |
| PAC   | Dralon T      | 125           | 140      | 4    | 3      | 4-5        | 3         | 3-4      | 1.6            |
| PPS   | Ryton         | 180           | 200      | 4    | 4      | 5          | 1         | 3        | 5              |
| APA   | Nomex         | 200           | 220      | 1    | 4      | 2          | 3-4       | 5        | 5              |
| PI    | P84           | 240           | 260      | 4    | 2      | 2          | N/A       | 4        | 6              |
| PTFE  | Teflon        | 230           | 260      | 5    | 5      | 5          | 5         | 3        | 15             |
| GLS   | Fiberglass    | 240           | 280      | 4    | 3      | 5          | 5         | 1        | 2-3            |

|  |  |  |  |  |  |  |  |  |  |
|--|--|--|--|--|--|--|--|--|--|
|  |  |  |  |  |  |  |  |  |  |
|--|--|--|--|--|--|--|--|--|--|

#### 4.10 Fabric treatments

To improve the properties of the fabric, some treatments are possible. These can increase the fabric's resistance and filterability, but they cost more capital to produce.

**Needle felts** usually consist of two homogeneous layers of fabric known as batts and a supporting fabric between the layers named scrim.

In the batt, the fibres are randomly distributed in 3-dimension space so as to make a felt that creates a high air-to-cloth ratio and a large fibre surface that increases filtration efficiency and allows collection of particles on and into the fabric.

**Scrim** provides strength and stability in the felt and is usually a woven fabric with plain weave construction.

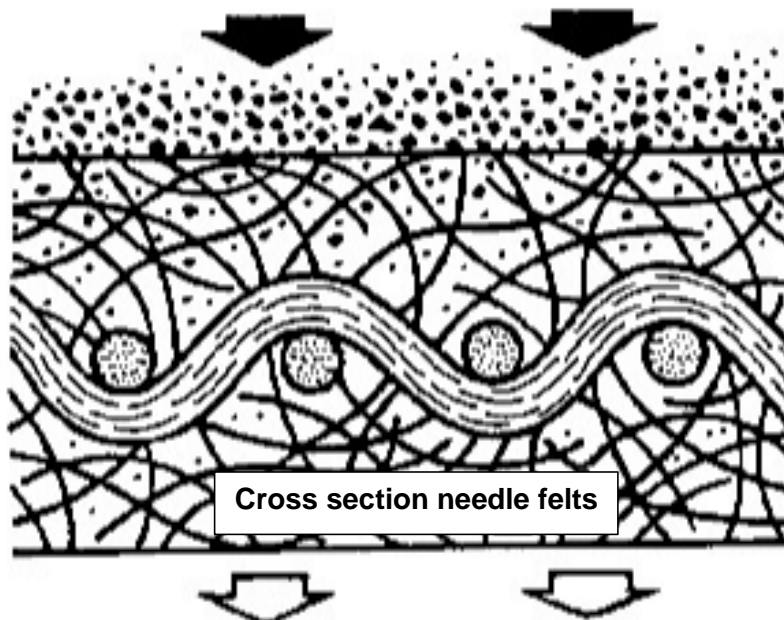

Figure 22. Cross section of needle felts[12]

**Woven fabric** can also be used in pulse-jet filters as it has low requirements on macro-homogenous permeability and active fibre surface.

The woven fabric usually consists of two yarns perpendicular to each other (Figure 23). The yarn running lengthwise is known as the warp and the one running crosswise is

usually called weft (Figure 24). The warp is the source of stability and strength, and the function of the weft is to filter and to give strength. [12]

**Fill** – Ends that run crosswise in a fabric.

**Warp** – Ends that run lengthwise in a fabric.

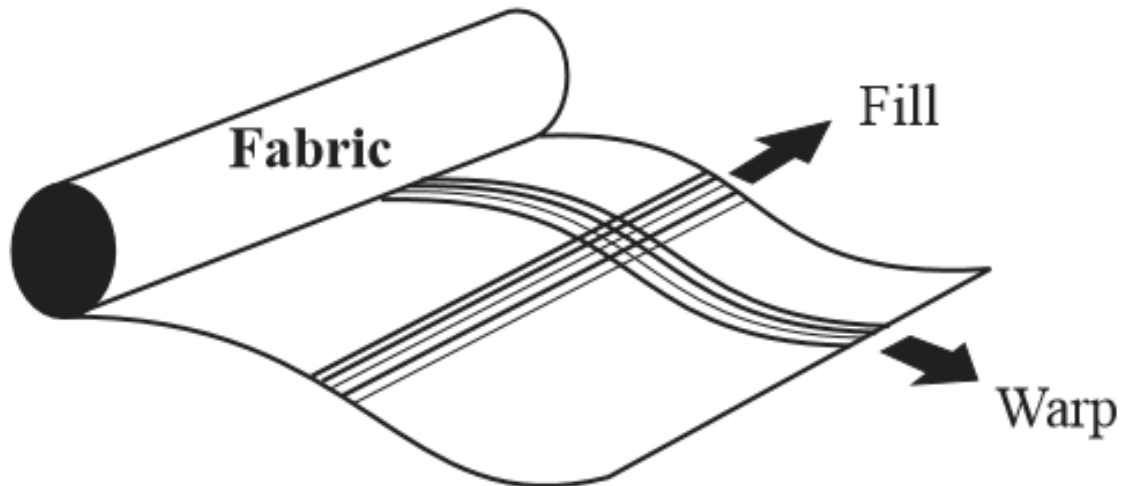

Figure 23. Simplified image of fabric [12]

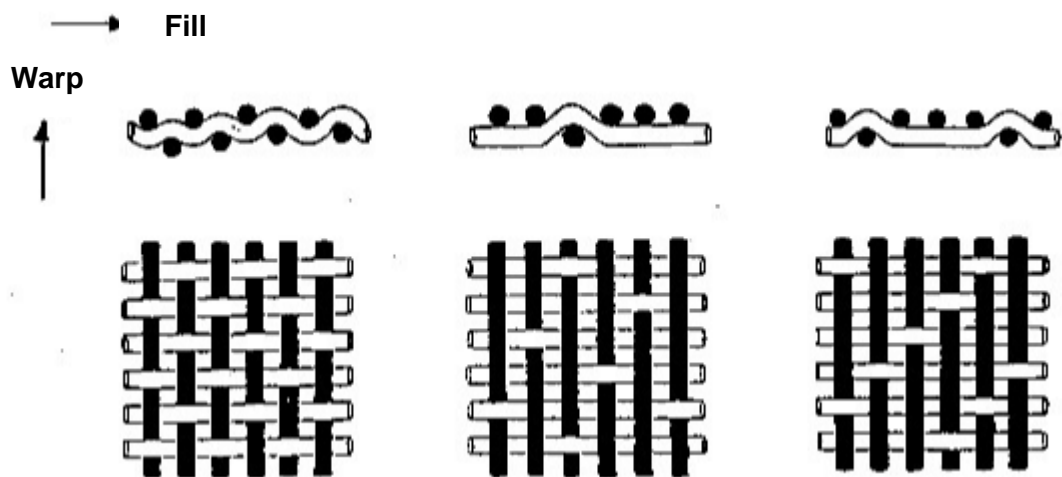

Figure 24. Fill and warp arrangement [12]

Chemical finishing of the fabric include the following:

- Silicon aqueous, silicon paste, silicon oil
- PTFE pastes, PTFE-powders
- Teflon B
- Teflon

- Fluorocarbons

## Felts

Felts are composed of a relatively thick (up to around 152mm) matt of densely packed, randomly oriented, fine fibres. They are sometimes needed for a supporting open-woven-scrim fabric.

The filtration mechanism of felts is through the extremely fine interstices between these fibres.

Because felts do not depend primarily on a particulate dust cake for their filtration function, they operate at very high collection efficiencies from start-up and continuously provide high collection efficiencies even immediately after cleaning cycles.

It has been pointed out that filtering efficiency greatly depends on fibre size; those felts employing fine fibres in their construction have higher filtering efficiencies than those employing coarser fibres.

## Membranes

Membranes consist of a woven or felted backing to which an extremely thin, porous membrane is bonded. It is the surface of this membrane which performs most of the filtration. Although membrane fabrics have very good particle capture efficiency, they are fragile and can be damaged easily during installation. When filtering fine, non-agglomerating dusts, the membrane pores may become clogged by dust particles, resulting in very high operating-pressure differentials (or, ultimately, blinding). [12] Pre-treatment processes are listed in Table 5.

Table 5. Pre-treatment processes table

| Pre-treatment | Method                         | Result                         | Reason for use   |
|---------------|--------------------------------|--------------------------------|--|
| Calendaring   | High pressure pressing rollers | Flattens, smooth, or decorates | Increase surface life<br>Increase dimensional stability<br>Provide more uniform fabric surface |
| Napping       | Scrapping across metal points  | Raises surfaces fibres         | Provide extra area for interception and diffusion  |



|          |   |                                 |  |
|----------|---|---------------------------------|--|
| Singeing | Passing over open flame                         | Removes straggly surface fibres | Provides uniform surface area  |
| Glazing  | High pressure pressing at elevated temperatures | Fibbers fused to filter medium  | Improves mechanical stability  |
| Coating  | Immersing in natural or synthetic resin         | Lubricates woven fibres         | Provides high temperature durability<br>Provides chemical resistance for various fabric material |

[12]

#### 4.11 Bag life

The bag life is correlates with forces that are applied to the fabric, such as thermal, mechanical and chemical forces as all of these have a compound effect on the bag life.

Chemical degradation is usually caused by a contaminant present in the gas or dust and is influenced usually by temperature. For example, a temperature peak that is not harmful to the fabric could activate an accelerated chemical degradation that is harmful.

Mechanical degradation can be caused by blasting on the surface of the fabric or internal wear because of fine particles penetrating the fabric and abrasion between fabric and the cage.

It can be noted that chemical degradation progresses at an exponentially decreasing rate, while the mechanical degradation is accumulative and proportional to the number of flex cycles and the time of exposure to erosion and abrasion from the dust. The graph in Figure 25 depicts the behaviour degradation.

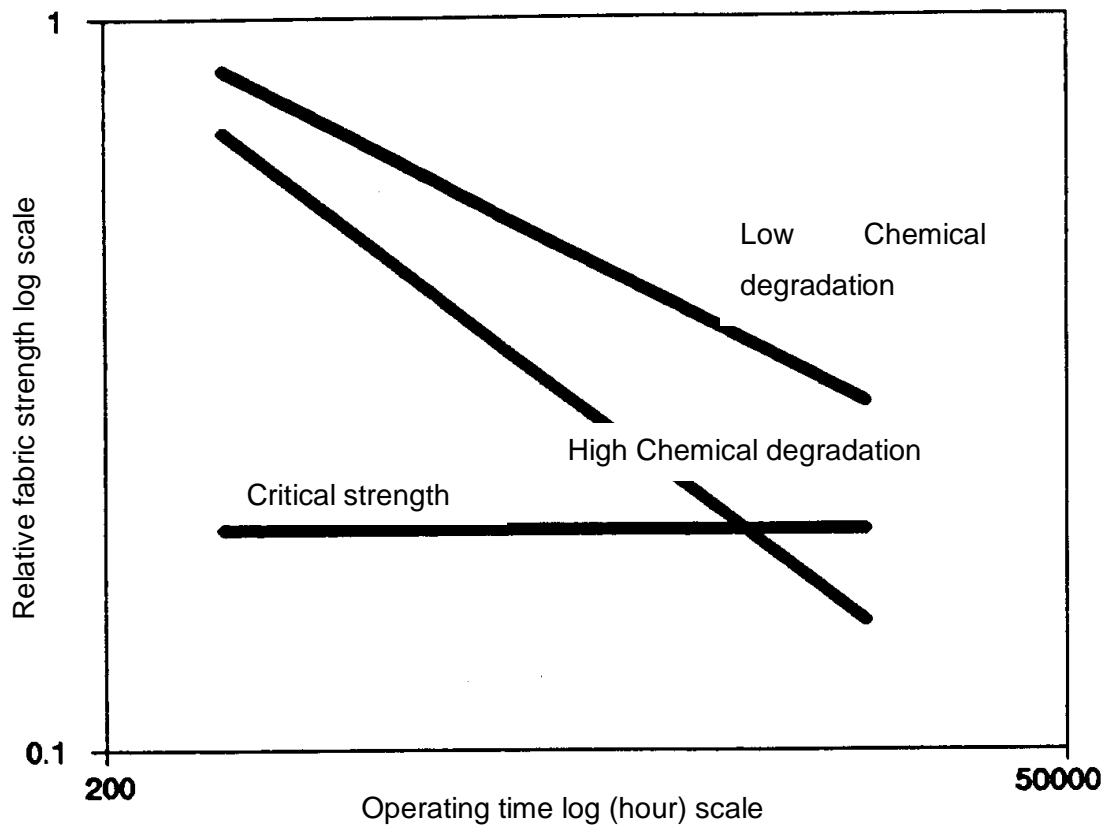

Figure 25. Behaviour of the degradation. [16]

Different fabrics have different weakness and strength with regard to chemical attacks. Most synthetic fibres have an acceleration of degradation correlated with higher temperature. According to the recommendation of most manufacturers, a 10 °C higher temperature gives twice the degradation rate.

Strength loss is critical when a set limit value is achieved in which the mechanical failure rate increase exponentially according to statistical frequency distribution; thus, in order to keep up the rate of bag replacement with the growing failure rate, replacement of all bags is initiated when about 10% of the bags have failed. This is the mechanical bag life.

#### 4.12 ID Fan

Operational cases of the ID fan are as follows:

- Design case
- Normal run
- Minimum load run

When the ID fan works in the above listed conditions, it must respect the performance requirements that are expected.

It might be harmful to set excessive performance requirements on design case or minimum load case. It is possible that there are cases in which the plant is likely to operate, but not for significantly long periods. There is a chance that if you have good efficiency on minimum load case, on the normal run case, the ID fan may operate at lower efficiency, or maybe it will operate with good efficiency, but with a more sophisticated (expensive) design.

The best fan design foresees the use of a variable-speed drive that will optimize operative costs, after a small the initial investment. [13]

An example of overestimating the fan size is given in Table 6.

Table 6. Fan sizes table [13]

|                       | Normal run | Over design +5% | Over design +10% | Over design +20% |
|-----------------------|------------|-----------------|------------------|------------------|
| Increase in power use | 1          | 1,16            | 1,33             | 1,74             |

#### 4.13 Control Unit

Usually placed on the top of the filter, the control unit can operate the valves using a timer, pressure difference or a mixture of both also possible to operate the valves manually.

When the valves are operated by pressure difference, the cleaning will start when the pressure difference is at a specific value, usually called the 'upper set point' it's typically around 1500 Pa, but it can be altered depending on various factors such as fan size. The cleaning will then continue until the pressure difference has lowered to another value usually referred to as 'lower set point', the interval between the set point is typically 50 Pa.

When operating in a mixed timer plus pressure difference, the system will operate by pressure difference unless a certain amount of time has passed since the last cleaning

this form of operation is used for the purpose if the dust stays too long on the bag surface, a chemical reaction may occur and it would be difficult to dislodge.

As the pressure drop depends on both the filtering velocity and the dust cake, the dust cake will increase at low loads. When the load is increased, this will result in a great fall off dust in a short time, and that can over-load the dust handling system. It's economical to initiate the pulse from the timer at a low load so as to reduce the pressure difference.

#### 4.14 Theory related to fabric filter

This subsection presents the background on the physical formulas and, describes the description of behaviour of the fabric filter and explains how it can be predicted. Figure 26 demonstrates the filter mechanism for particle removal.

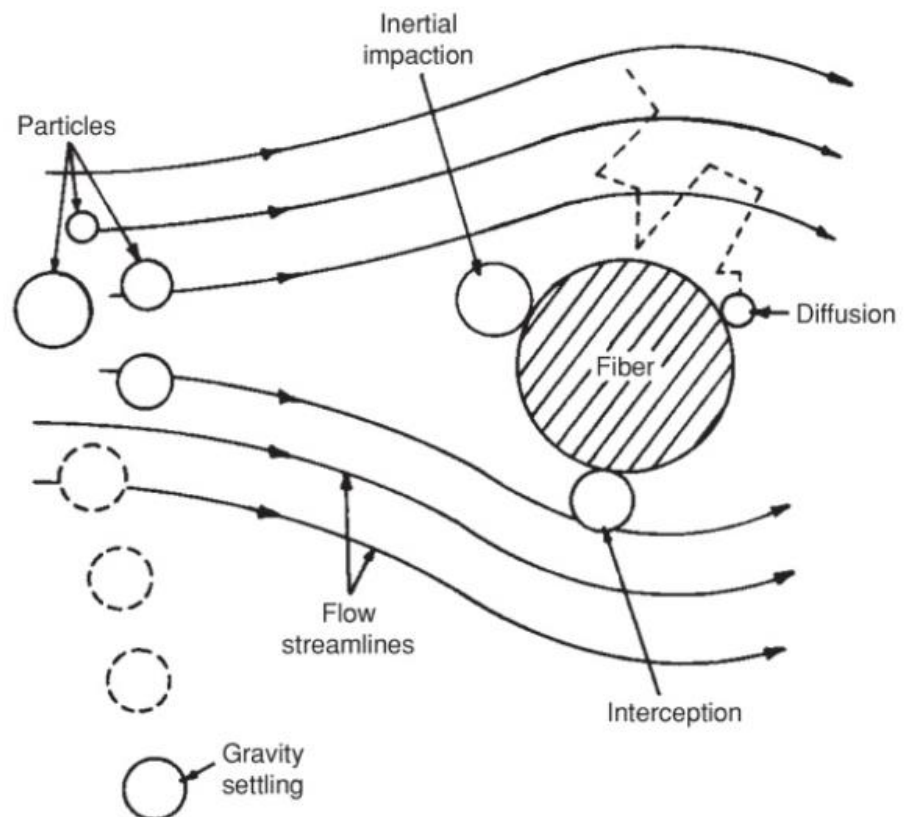

Mechanisms for particle removal by a filter

Figure 26. Mechanisms for particle removal by a filter [14]

*Fixed cycle* is the most easy to be realized: after a certain time, one of the bags is cleaned by a blow of compressed air.

The problem in estimating the fixed cycle is that samples of the dust cake need to be collected to test how it is built on the filter bags to know the optimal time for the cycle. Estimating would be less efficient if the fuel is, for example, changed.

*Variable cycle* makes an improvement because the cleaning cycle time varies in order to keep the bags dp as constant as possible. The filter is set to the desired dp, and the control system cleans the bags when necessary so that the dp stays constant.

Advantages are that the bag filter will run in a flat and stable way, and power consumption and compressed air consumption will be constant; also the system will react smoothly to variable dust loads. It is necessary to install sensors into the fabric filter to measure the pressure difference and a more expensive control unit to operate them, which allows operations without knowing the nature of the dust cake being built in the fabrics.

### **Sizing the fabric filter**

Usually the filtration velocity is set at 1 m/min; in conventional fabric filter hybrid filters filtration velocity is slightly higher, at 1.5 m/min.

Gas flow has to be estimated in m<sup>3</sup>/s

Air to cloth ration

The air-to-cloth ratio is the volumetric flow rate of air (m<sup>3</sup>/minute) flowing through a dust collector's inlet duct divided by the total cloth area (m<sup>2</sup>) in the filters. [13]

$$\text{Air to cloth ration} = \frac{\text{Gas Flow}}{\text{Cloth area}}$$

Cloth area is calculated with the following equation:

$$\text{Cloth area} = \frac{\text{Gas Flow}}{\text{Filtration Velocity}}$$

To estimate the minimal number of bags, the area of the bags in square metres is divided by the height of the bag in metres [13]:

$$\text{Minimal number of bags} = \frac{\text{Cloth area}}{\text{Area of the bags}}$$

### Pressure Drop (Differential pressure)

Pressure drop is a very important fabric filter design variable; it describes the resistance to air flow across the fabric filter: the higher the pressure drop, the higher the resistance to air flow. The pressure drop is usually expressed in millimetres of mercury or inches of water. The pressure drop of a system (fabric filter) is determined by measuring the difference in total pressure at two points, usually the inlet and outlet. The total system pressure drop can be related to the size of the fan that would be necessary to either push or pull the exhaust gas through the bag-house. A fabric filter with a high pressure drop would need more energy or possibly a larger fan to move the exhaust gas through the fabric filter. [14]

The high pressure drop pulls particles through the bags. Over time, high pulse pressure causes fibres to open up allowing dust to penetrate, which will lead to much higher energy costs to run the system fan at high speed and can, if overtaxed, lead to premature fan/motor failure. If the system fan is not adjusted to compensate for the higher differential pressure, the system will lose draft at all of its pickup points. This will mean less performance from the system.

Estimating the pressure drop is difficult as empirical data is needed in almost all cases about the dust cake as the nature of the flow gas varies greatly per process.

The simplest equation used to predict the pressure drop across a filter is derived from Darcy's law governing the flow of fluids through porous materials and can be written as follows:

$$\Delta P_{\text{fabric}} = k_1 * v_f$$

Where  $\Delta P_{\text{filter}}$  is pressure drop in the clean fabric (Pa), and  $k_1$

- $k_1$  = fabric resistance usually in Pa/m/s

On a note on the nature of  $k_1$  when possible its determined empirically but there is a possibility to estimate a theoretical value of this resistance coefficient from the properties of the cloth media. [14]

$$k_1 = \varepsilon^3 * c * S^2 \quad (5)$$

Where  $\varepsilon$  is Porosity or fraction void volume (dimensionless),  $c$  is a flow constant,  $k_1$  is the Kozeny coefficients ( $m^2$ ), and  $S$  is the specific surface area per unit volume of porous media. [14]

- $v_f$ = filtration velocity (m/s)
- A more exact pressure drop can be calculated using the following formula:

$$\Delta P_{fabric} = k_1 * v_f * (U_g/U_a) \quad (6)$$

- $U_a$  = Air dynamic viscosity at 20 C

$$\left(\frac{U_g}{U_a}\right) = \left(273 + \frac{T_g}{293}\right)^{0.76}$$

- $T_g$  = gas temperature in Celsius

There is also possibility to predict the pressure drop caused by the dust cake with the following equation.

This formula is also derived from Darcy's law and the simplified form is given as: [15]

$$Pressure\ drop\ cake = k_2 * c_i * v_f^2 * t$$

where:

- Pressure drop cake =pressure drop across the cake, Pa
- $k_2$ =resistance of the cake, Pa/ (g/cm<sup>2</sup>-cm/sec)
- $c_i$ =dust concentration loading,(g/cm)
- $v_f$  =filtration velocity, (cm/sec)
- $t$ =filtration time, min (sec)

It is also possible to conclude that the correction factor for temperature can also be applied;

$$Pressure\ drop\ cake = k_2 * c_i * v_f^2 * t * (U_g/U_a)$$

The  $k_2$  is the dust-fabric filter resistance coefficient and is determined experimentally. This coefficient depends on gas viscosity, particle density and dust porosity making prediction without sample all but impossible as it can change greatly depending on application.

There are number of factors that increase cake resistance such as the following:

- Decreased dust particle diameter (this is most relevant as the particle in the hybrid filter will have low diameter when compared to normal fabric filter)
- Increased filtration velocity as it creates a more compact cake
- Decreased particle cohesion forces also create a more compact cake

The cake pressure drops vary throughout the cleaning cycle being obviously higher just before the pulse and lower after it as the pulse does not clean the entire cake. It has been observed that usually half of the cake remains after cleaning. [15]

Another way of calculating that is recommended by the EPA is presented below:

$$\text{Pressure drop} = k_1 * V + (k_2 * w_r * C_i * (V^2) * t) / 7000$$

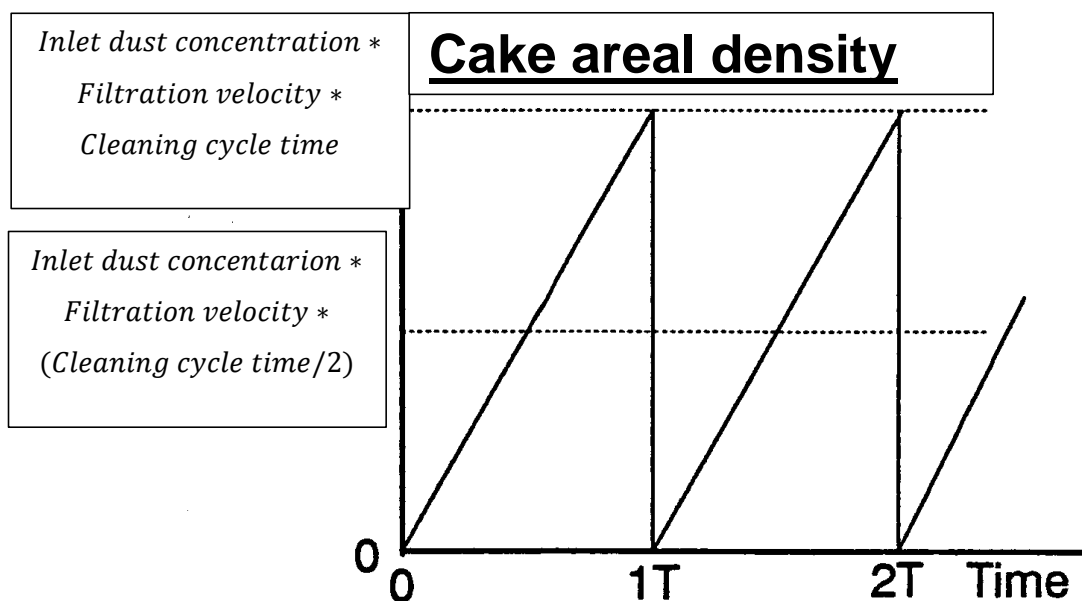

Figure 27. Behaviour of the cake areal density[16]



The factor contributing to pressure drop in an ESP are given in the table x below. They can be used as a guide in estimating the pressure drop in a hybrid filter. As can be seen, they would be where small part of the total pressure drop.

Table 7. Typical pressure drops in ESP [3]

| Components        | Typical Pressure drop in ESP Pa |               | notes |
|-------------------|---------------------------------|---------------|-------|
|                   | Low Estimate                    | High Estimate |       |
| Diffuser          | 2.49                            | 22.4          | *     |
| Inlet transition  | 17.4                            | 34.8          | *     |
| Outlet transition | 1.74                            | 3.73          |       |
| baffles           | 0.15                            | 30.6          | *     |
| Collection plates | 0.0747                          | 1.99          | *     |
| Total             | 22.4                            | 94.6          |       |

\*Usually maintained in the retrofit

To equalize the gas flow throughout the face of an ESP, a diffuser plate is installed. Diffuser plates are flat plates covered with holes with a diameter between 5 to 7 cm that covers between 60-65 percentages of the total plate area. It is noted that the pressure drop is strongly dependant on the percentage of area covered, but the hole size does not seem to affect the pressure drop.

At the inlet pressure drop occurs because of two factor: one is the effect of flow separation and the other is wall friction. The inlet pressure drop influenced by the shape of the enlargement in the inlet, at the outlet the pressure drop caused by a short, well-stream-lined gradual contraction is small. [3]

The function of baffles is to shield the collected dust from the gas flow and to provide stiffening effect to keep the plates aligned parallel to one to another. The pressure drop due to the baffles depends on the number of baffles, their protrusion into the gas stream with respect to electrode-to-plate distance, and the gas velocity in the ESP.

The pressure drop of the flat collection plates is due to friction of the gas dragging along the flat surfaces and is so small compared to other factors that it may usually be neglected in engineering problems.

Values usually used to predict pressure drop in fabric filter when it is not possible to estimate it by calculation because of limited data are given in Table 8 below.

Table 8. Typical values in a Pulse jet fabric filter

| Parts   | Pa                 |
|---|--------------------|
| Pulse jet fabric filter over-all loss                 | 1500 to 2500       |
| Mechanical loss (manifold dampers, entrance and exit) | 500 typical values |
| Cake pressure drop                                    | 980                |

In the end the total pressure drop is the sum of all know pressure drops.

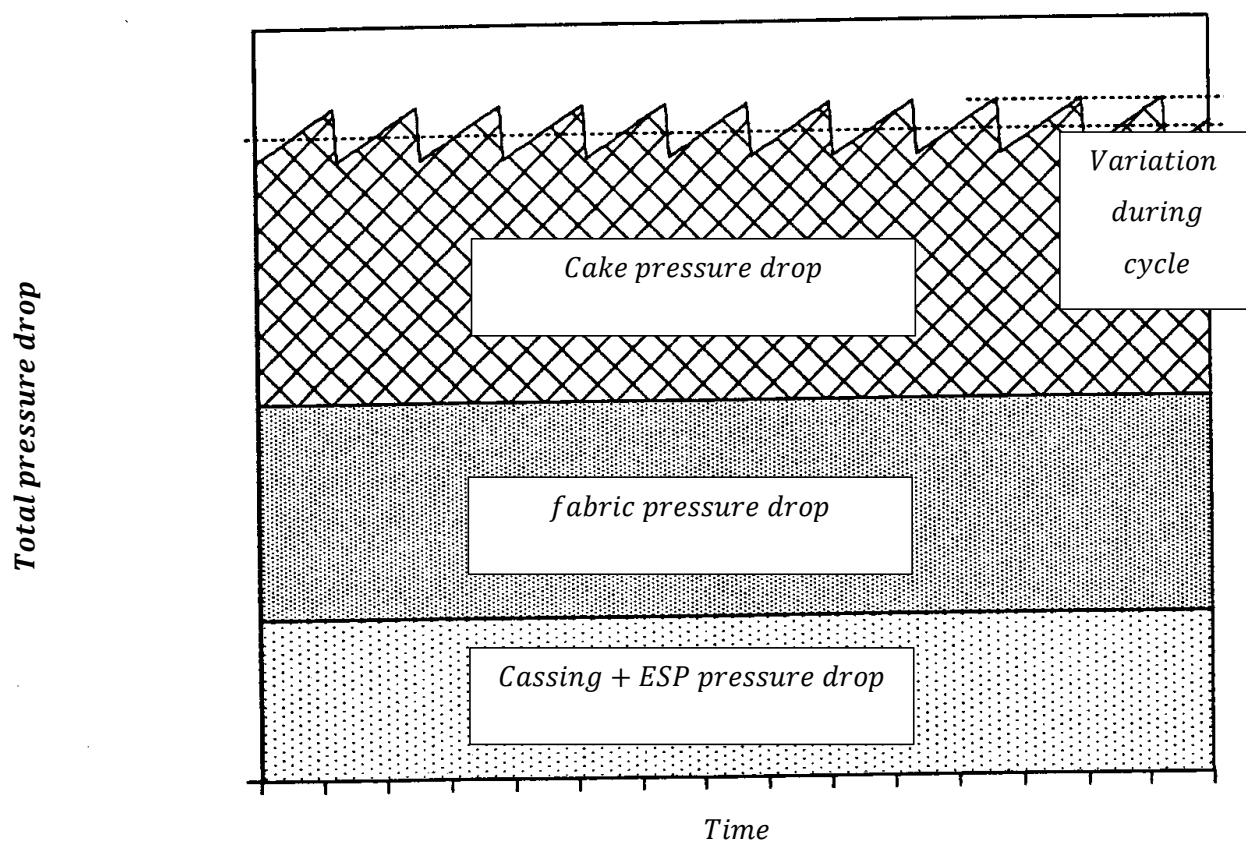

Figure 28. Pressure drop behaviour

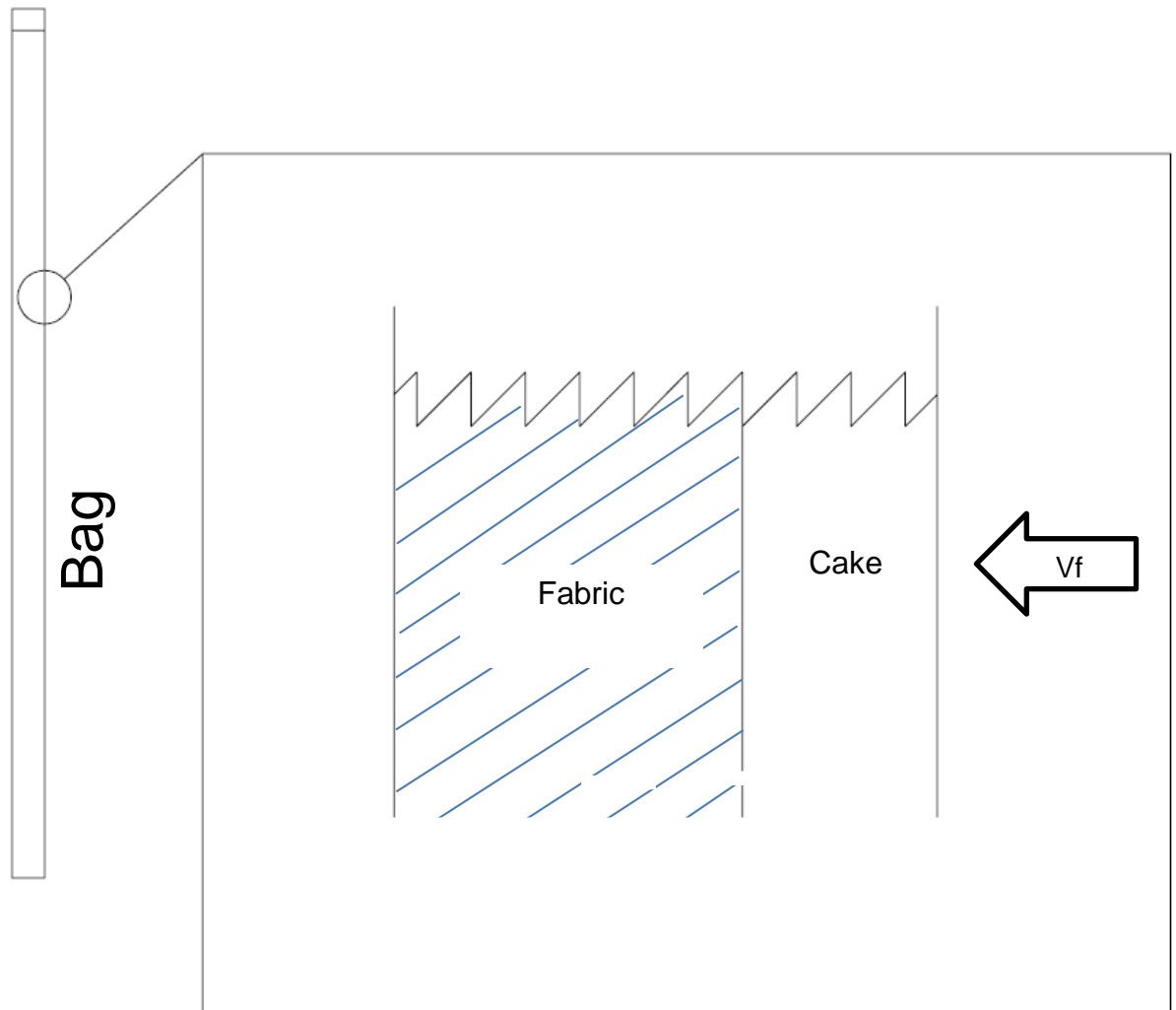

Figure 29. Barrier in a bag

**Can velocity:**

Can velocity is a very important parameter in the bag filter design as it gives an estimate of the free space between gases to be traded inside the filter, an excessive can velocity contrasts the dust precipitation from the bags down below the collection hoppers, generating excessive pressure drops.

For bag filters, it is a common practice to keep the can velocity below 1.3 m/sec at the design flow rate. When converting an electrostatic precipitator into a bag filter, the existing casing dimensions could be a major constraint. [13]

It limits the spacing between the bags as it gives you the idea of the free space between bags available for gas to be treated to flow inside the filter [13]:

$$\text{Can Velocity} = \frac{\text{Flue Gas Flow Rate}}{3600 * (\text{tube sheet area} - N_{\text{bags}} * D_{\text{bags}}^2 * \frac{\pi}{4})}$$

Typical Units are listed below:

Can Velocity [m/s]

Flue Gas Flow rate [Am<sup>3</sup>/h]

Tube sheet area [m<sup>2</sup>]

D<sup>2</sup>bags [m<sup>2</sup>]

## 5 ESP-FF retrofit

This chapter addresses the preparations for and the details in retrofitting an existed ESP into a hybrid arrangement. The basic arrangement of a simple ESP-PJFF retrofit is shown in Figure 30.

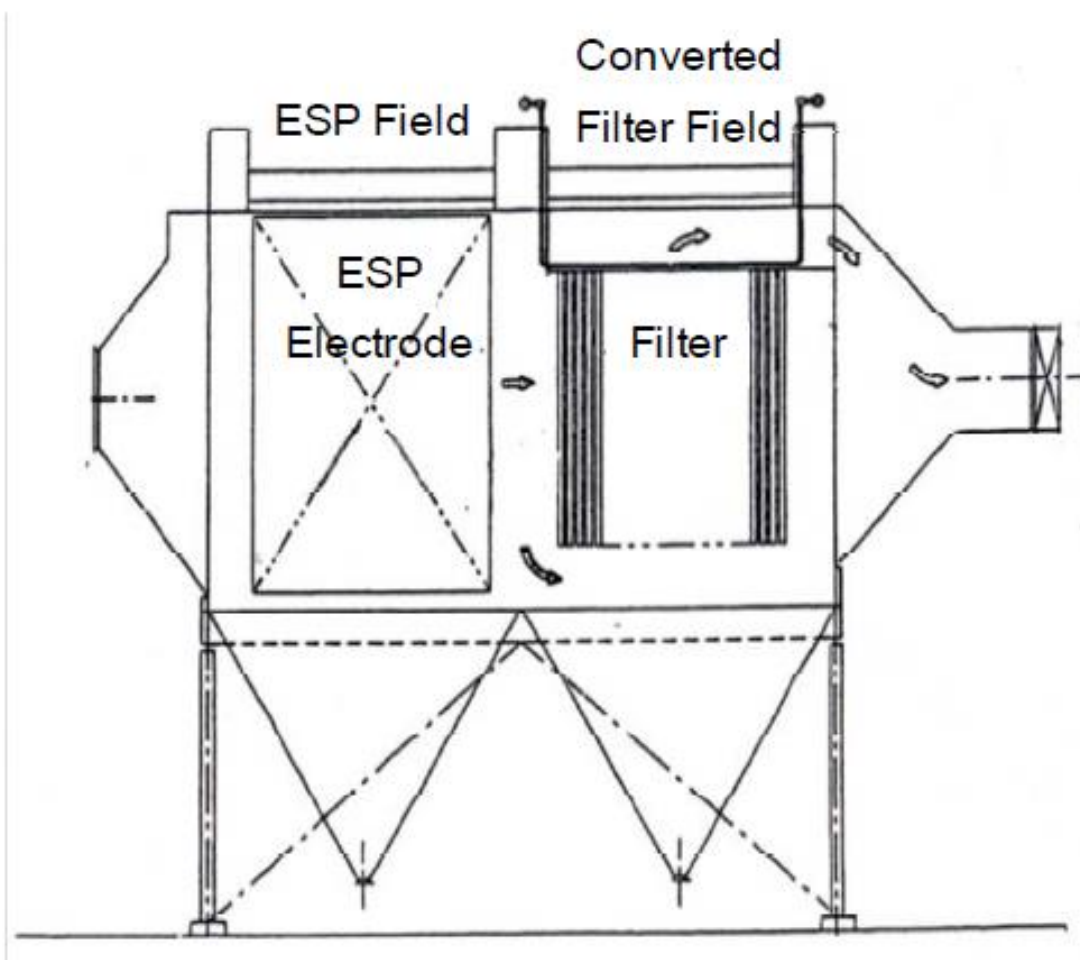

Figure 30. Basic arrangement of a simple ESP-PJFF retrofit

The benefits of a hybrid system are usually more apparent in a retrofit of an existing ESP than in a case where a filter is installed in a plant without any gas control. [17] An obvious advantage in using the existing structure is that there is very little change in the amount of space used by the filter.

There are cases of complete conversions from ESP to fabric filter creating a supply of knowledge in how to perform the ESP-FF retrofit as the design is almost the same and the option to convert the filter completely is an old concept.

In many cases it is possible to keep the existing side walls and hoppers without modification, sometimes the duct work and material handling can be reused.

One of the question is how the clean air plenum is installed in the structure inside the structure or built on the top of the structure this decision has to take into account the

temperature of the gas stream, the size of the existing ESP, the desired gas flow, and the types of fabric filters to be used. [18]

When retrofitting an existing ESP, in most of the fields, the plates are removed as it is necessary to have only around 80-90% removal efficiency. This can be achieved with a very small ESP. The rest of the field are converted to a fabric filter to collect small particles that are usually not collected by the remaining small ESP. [16]

Two Electric fields would be ideal for an ESP-FF although one would be sufficient. There is the possibility of short-circuit, and the pre-dust function of the electrostatic precipitator will be lost, the load resistance of the dust collector increases with the load of the fabric filter, but considering the amount of dust removed from the process, the second field would not be as significant as the first field. [19]

The resistance behaviour of the ESP-FF is similar to the fabric filter, which means that the resistance is lower at the beginning of operations. [19]

To avoid excessive bag failure, it is necessary that the gas flow in a uniform manner around the bags, and in such a manner that no high velocity streams of gas impinge directly on the bag surfaces. In addition, it must be decided on whether to implement a side or bottom gas entry or a combination of both. [20]

If the number of ESP fields increase, there is a tendency that the particle load that enters the fabric filter becomes lower with a finer particle size distribution.

The consequence, which is the reduction of cleaning time, but it is not as significant as most would assume as the dust layer that forms around the bags is more compact due to the finer size of the particles.

To sum up, when the number of active fields in the ESP is increased, the dust concentration entering the fabric filter is lower but the particles are finer.

As to the pressure drop caused by the dust accumulated on the bags since the last bag cleaning, we can say the two terms partially counteract each other; the dust in the inlet gets lower and the resistance of the cake ( $k_2$ ) gets higher.

For very small dust particles, the dust cake resistance ( $k_2$ ) will tend to be high, causing a higher pressure drop across the dust layer. Cora and Hung [20] pointed out, as a rule of thumb, that fabric filter used for filtering dirty airstreams containing a relatively high number of very small particles (2 $\mu$ m or less) will tend to have a high dust cake resistance ( $k_2$ ), requiring a more frequent bag cleaning cycle, i.e., an increase of the cleaning time. In fact, this occurs in the fabric filter section of the hybrid collector when the previous ESP section is energized.

Lower rates of pressure loss and fewer cleaning cycles per day can be expected when the number of active ESP fields is higher, as it will reduce the amount of particles that will enter the fabric filter. [21]

A necessary step that needs to be taken during the retrofit is the removal of the internal from the ESP. This is usually possible through the roof.

Duck work modification is always necessary because of the nature of the fabric filter. This is typical disadvantage of the fabric filter.

The PJFF will create additional pressure loss to the plant. Additional fan power and structural upgrades may be necessary.

The **PJFF** has usually higher pressure loss than an ESP so it is necessary to increase fan power and possible to fortify the structure of the ducts.

The PJFF will become part of the plant process and filter bag pressure drop must be controlled.

Upgrading of Induced Draught (ID) fans is necessary as the differential pressure across a PJFF is considerably higher than across an ESP, and therefore it is usually necessary to increase the suction capacity of the ID fans in order to accommodate the additional load.

It is recommended before stating any retrofit is necessary to get the following information about the plant and the ESP:

- Lists and documents of all existing APC equipment including DSI & Ash disposal installations
- Inspection results for corrosion/erosion
- site specific construction limitations
- Plant max and min operating conditions: base loaded, low load operations, and/or peaking station operation durations
- Main Fuel/Fuels burned and all additives.
- Start-up and/supplementary fuels fired.
- Max/Min Loads with Volumetric Flue Gas Flow Rates and Temperatures.
- Fly ash analysis and quantity at the ESP inlet and outlet.
- Max/Min Sulphur Levels in Fuel and SO<sub>2</sub>/SO<sub>3</sub> Levels at the ESP Inlet
- Emission test data for PM<sub>f</sub> and PM<sub>c</sub> if available.
- ID Fan provider design curves, and existing capacities.
- Environmental emission agreements and requirements.
- Data, drawings, integrity, and overall condition of all the impacted existing equipment.[15]

Based on the Figure 31 below is possible to conclude that the gas velocity is uniform when it arrive at the fabric filter part of the filter.

So is not always necessary to have baffles plate between the filter.

If possible to create a velocity contour of the specific filter to confirm it would be recommend otherwise assume uniform velocity in the fabric filter.

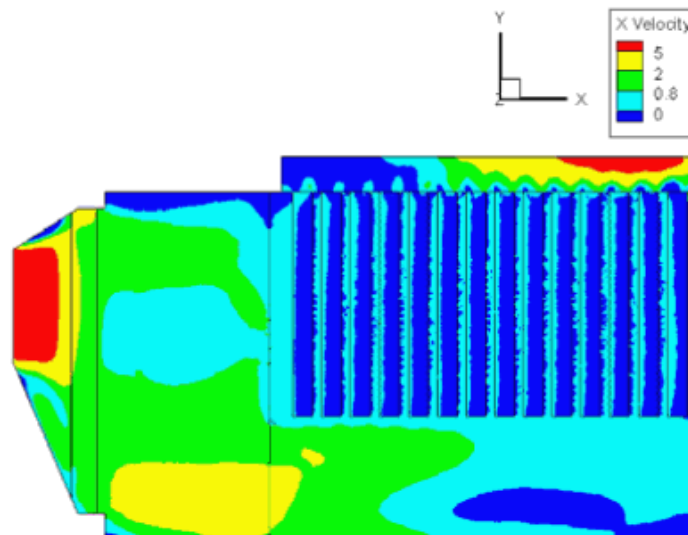

X velocity contour in a Z plane, Opening ration=42%

Figure 31. An example of gas velocity in the hybrid filter [22]



The flow distribution has an important role in the performance or collection efficiency of PJFF-ESP hybrid, especially of the ESP section as the gas distribution is not as important in the hybrid filter as it is with the ESP as the filter bags will in any case collect the dust. It may affect its pressure loss but probably not significantly. However, the installation of the bags will affect the efficiency of the ESP section the installation of the bags in a negative manner. [22]

Simulation in other Hybrid filters shows that the gas distribution is even, and it is theorized that because of the high pressure drop across the bags if compared to everything else in the filter, it is also worth noting that in the case of more chambers, the first fabric filter compartment has a slightly higher gas velocity which is acceptable parameter.

The importance of a baffle in a filter with only two compartment is great as it result in an acceptable level of gas velocity in case of more compartments are not essential for a hybrid filter. [15]

### 5.1 Calculation

For the retrofit, it is necessary to estimate the space available for the fabric filter. It is necessary to keep in mind how much space the header tanks will take and that there is enough space between the bag house cages.

- Filtration velocity
- Gas Flow
- Cloth Area
- Number of bags
- Air to cloth ration

## 6 Price comparison between filter options

With the objective to explain how the price comparison was made this chapter highlight the option chosen for each filter with relation to a case study that will be explained later in the thesis, so as to better understand the method utilized.

Comparing the building of new ESP to meet new limit values with retrofitting the old ESP in to a hybrid design or fitting the whole ESP into a fabric filter.

Total capital investment (TCI) for an ESP system includes costs for the ESP structure, the internals, rappers, power supply, auxiliary equipment, and the usual direct and indirect costs associated with installing or erecting new control equipment.

When building fabric filters the filter bags are usually the far most expensive element on the filter and when considering the conversion in a waste to energy or a biomass using plant only the most expensive type of fabric can be used and as retrofit usually doesn't involve compartmentation of the filter the bags has to be of high quality to survive until next maintenance that in a power plant could mean a year of 24h operation.

Estimating cost of building Fabric filter part.

### 6.1 Prices estimate for Construction and choosing materials

To estimate the price, a case study of a power boiler filter in Finland was used with the information about the process of the plant available. Some of the information is included in the (Appendix 1 and Appendix 2).

To estimate the price, various manufacturer of the part were contacted for an offer for components of the fabric filter. The price was extrapolated from construction of another fabric filter some information is available in the appendix. (Appendix 1 and 2)

The various fabrics on the list are there to compare how the cost of fabric filter is affected by the fabric.

The Trimec tank was used because it was the cheapest to operate and because there was a test that confirmed the company's claim on their product. The other tanks were not tested, the other tank weren't tested.

The PPS+PTFE(scrim) was chosen for the fabric because it has the necessary qualities to survive in the environment that the filter would stand and was recommended by more than one manufacturer as a material which can support temperature peaks of 200 °C.

Is a composition of PPS+PTFE (scrim), Because 200°C is the edge value for 100% PPS, and the safe level of NO<sub>2</sub> for PPS is lower than 15 mg/Nm<sup>3</sup> at 160°C.

### **Total cost**

The following equation was used to calculate maintenance costs of the bag house filter

$$\text{Electric cost} = (C * E) * dp * H * K * S$$

$dp$ = Pressure drop (pa)

$H$ =Annual operating time (h/year)

$K$ =Power Cost (Euros)

$S$ =Design capacity of bag house (m<sup>3</sup>/s)

$C$ = Constant

$E$ = Fan efficiency

The power requirements for an electrostatic precipitator part are approximately 16 kg/s<sup>3</sup> (1.5 W/ft<sup>2</sup>) of collection plate area. The range varies from 3.2 to 32 kg/s<sup>3</sup> (0.3 to 3 W/ft<sup>2</sup>).

Once the power requirement is known, the annual power costs can be calculated using the following equation:

$$\text{Annual power cost (Euros)} = \text{Power usage (kW}\cdot\text{h)} \times \text{Cost of power (Euros/kW}\cdot\text{h)} \times \text{Total annual operating (hrs)}$$

$$\text{Maintenance Cost} = \text{Bag Replacement Cost} + \text{Bag Maintenance}$$

### **Construction cost of a fabric filter retrofit**

Operating cost of ESP

$FP$ = fan power requirement (kWh/year)

$Q$ = system flow rate (m<sup>3</sup>/s)

$P$ = system pressure drop (pa)

$t$ = annual operating time (h/year)

The assumed values used in the calculations are given in the table 9. They are based on the information provided by the operator of the plant.

Ideal power means power provided without losses.

Table 9. Comparison calculations showing the assumed price of electricity and other parameters.

|                                |                                    |                     |      |
|--------------------------------|------------------------------------|---------------------|------|
| Fan power consumption PJFF Max |                                    |                     |      |
| Price of electricity           | 0,0676                             | Euros/kwh           |      |
| Power consumption of the fan   |                                    |                     |      |
| Real power                     | 1081060                            | KWh                 | year |
| Ideal power                    | 123400                             | W                   |      |
| fan power consumption ideal    | 108600                             | W                   |      |
| System flow rate Q             | 54,3                               | [m <sup>3</sup> /s] |      |
| Pressure drop delta P          | 2000                               | P                   |      |
| Operating time ø               | 8760                               | h per year          |      |
| Operating cost per year        | 73080                              | Euros               |      |
|                                | Assuming 88% efficiency of the fan |                     |      |
|                                | price of electricity               |                     |      |

This assumes that the ESP has a very low efficiency so the actual cost would be slightly lower, but as it is difficult to estimate the actual pressure drop because of lack of data, the only solution to calculate the fabric filter operation was assuming rather high pressure loss, which, as can be assumed, is closer to the real value.

Table 10. Calculating compressed air value used

|  |         |                          |
|--|---------|--------------------------|
| Compressed Air                                     |         |                          |
| compressed air used                                | 0,00094 | [m <sup>3</sup> /s]      |
| per flow rate                                      | 0,47    | [m <sup>3</sup> /s]      |
| ration of flow rate and compressed air consumption | 0,002   | ration                   |
| Consumption compressed air in the filter           | 0,1086  | m <sup>3</sup> /s        |
| price of compressed air                            | 0,61    | Euro/(m <sup>3</sup> /s) |
| Operating cost per year                            | 35100   | Euros                    |

Table 11. Replacement bag value table

|                   |   |      |
|-------------------|---|------|
| Replacement bags  |   |      |
| Replacement every | 4 | year |

|                |          |                |
|----------------|----------|----------------|
| One bag cost   | Censored | Euros          |
| Total          |          | Euros          |
| Total per year |          | Euros per year |

Annual cost of replacement bag could be estimated and it was based on the idea that the bag would be replaced every four years. Other part of ESP that was possible to estimate based on previous years power consumption and the specification of the manufacture of these parts and so could be accounted for are presented in the tables 12 to 16.

Table 12. ESP part of the hybrid filter value table power consumption and prices per year

|   |        |       |
|---|--------|-------|
| ESP part                                |        |       |
| Energy use                              | 42     | kW    |
| Energy per year                         | 367920 | kWh   |
| ESP fan power consumption cost per year | 5480   | Euros |
| Operating cost per year                 | 30350  | Euros |

Table 13. ESP other part power consumption and prices per year

|                                 |        |       |
|---------------------------------|--------|-------|
| ESP other                       |        |       |
| Hot air flushing                | 27     | kW    |
| Heating for support insulations | 16     | kW    |
| Raping motors                   | 1      | kW    |
| Energy use per year             | 385440 | kWh   |
| Operating cost per year         | 26050  | Euros |

Table 14. Other part of the filter power consumption and operating cost

|                          |       |     |
|--------------------------|-------|-----|
| Other parts              |       |     |
| Heating for bottom hoper | 9     | kW  |
| Energy use per year      | 78840 | kWh |
| Operating cost per year  | 5330  | kWh |

The costs of operating the ESP without modifications are given in Table 15

Table 15. Power consumption and operating cost of the ESP before modification

|                                 |         |       |
|---------------------------------|---------|-------|
| ESP not modified                |         |       |
| Energy use collecting plates    | 84      | kW    |
| Hot air flushing                | 27      | kW    |
| Heating for support insulations | 32      | kW    |
| Raping motors                   | 2       | kW    |
| Heating for bottom hoper        | 9       | kW    |
| Energy use per year             | 1349040 | kWh   |
| Operating cost per year         | 91195   | Euros |

The data on the amount of electricity used in the electrostatic precipitator was provided by the operator. It is assumed that the ESP operates for a year 24 hour a day.

Table 16. Fan power consumption caused by ESP rough estimate

|                              |        |                     |
|------------------------------|--------|---------------------|
| Fan power consumption ESP    |        |                     |
| Price of electricity         | 0,0676 | Euros/kwh           |
| Power consumption of the fan |        |                     |
| Real power                   | 16215  | KWh year            |
| Ideal power                  | 18511  | W                   |
| fan power consumption ideal  | 16290  | W                   |
| System flow rate Q           | 54,3   | [m <sup>3</sup> /s] |
| Pressure drop delta P        | 300    | P                   |
| Operating time ø             | 8760   | h per year          |
| Operating cost per year      | 10962  | Euros               |
| Total ESP                    | 102157 |                     |

With the above tables, is possible to make conclusions about the amount of resources to maintain the filters.

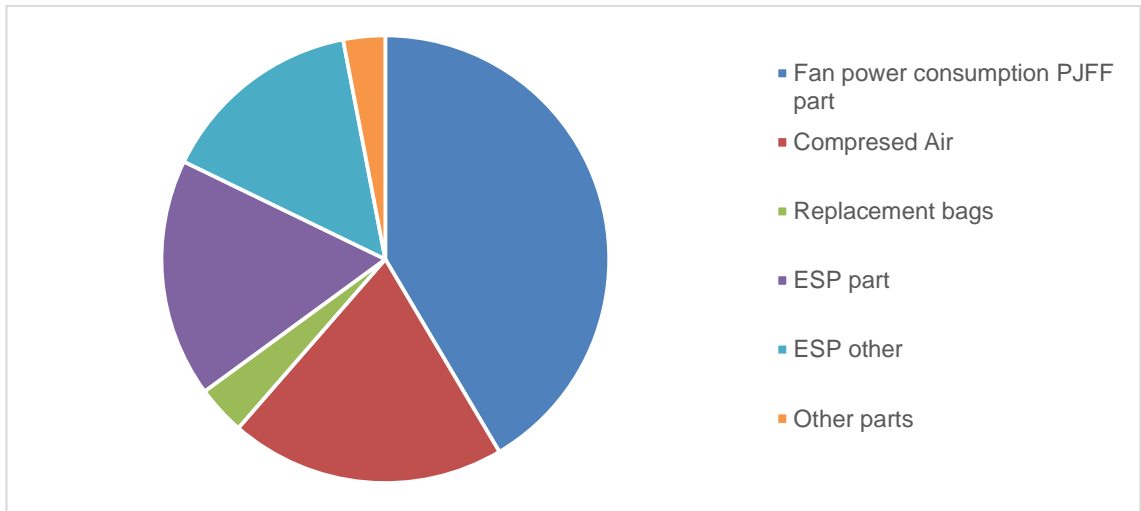

Figure 32. Chart operating cost in different part of the filter  
 As expected in fabric filters, the higher consumptions of resources is the pressure drop.  
 It was assumed that the maximum amount of dust is at the maximum capacity at all times

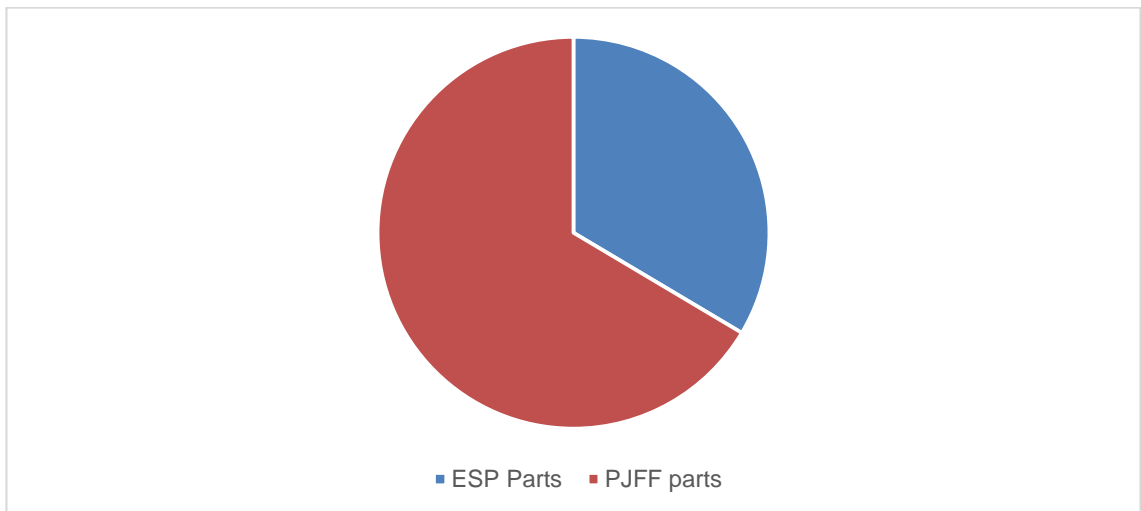

Figure 33. Operating cost per filter type  
 Most of the cost are caused by the fabric filter as Figure 36 and Table 6 show.

Table 17. Operating cost Euros per year

|                                |    |            |
|--------------------------------|----|------------|
| Operating Cost                 |    |            |
| Fan power consumption PJFF Max | ~x | Euros/year |
| Compressed Air                 | ~x | Euros/year |
| Replacement bags               | y  | Euros/year |
| ESP part                       | ~x | Euros/year |
| ESP other                      | ~x | Euros/year |
| Other parts                    | y  | Euros/year |

|                       |      |            |
|-----------------------|------|------------|
| ESP Parts             | ~x   | Euros/year |
| PJFF parts            | ~x   | Euros/year |
| Retrofit              | ~xxx | Euros/year |
| ESP(2 fields) current | xx   | Euros/year |
| 3 Field ESP           | xxx  | Euros/year |
| 4 Field ESP           | xxxx | Euros/year |

Table 18. Costs of operating each filter type

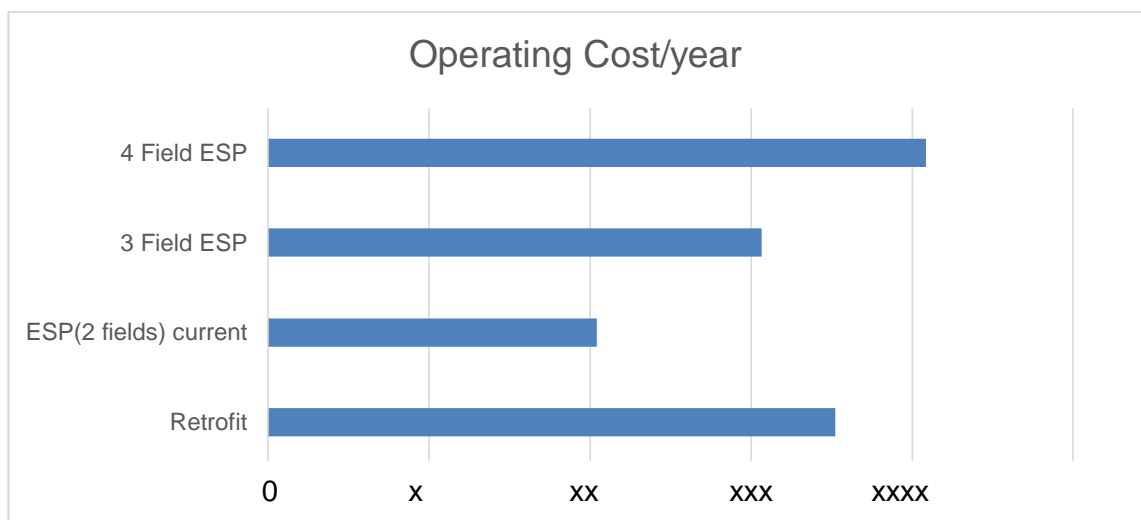

Figure 34 gives the information necessary to know that under no circumstances that a one field fabric filter will use more energy than a 4 field ESP (if all the field are operated). All this data are related to the fabric filter retrofit that is introduced below.



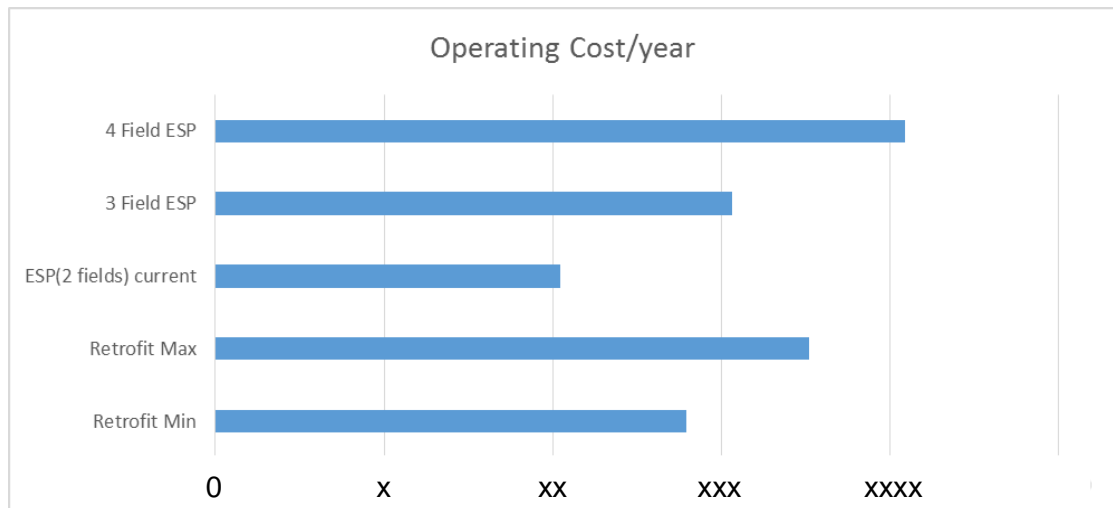

Figure 34. Operating cost chart with minimum theoretically possible energy consumption for hybrid filter included

Assuming that the object that is filtered has high or low resistivity, it is necessary to operate the ESP at full to get to or close to acceptable emission values (current ESP is insufficient). The values given suppose a 100% use of the ESPs field, which would only be true in case the fuel of the power plant would be problematic (this is the case currently).

There is a small possibility that the hybrid retrofit is the cheapest to operate but that would be rather unlikely, as it would involve a very slow accumulation of dust in the bags and an optimistic view of pressure drops caused by the installation.

## 7 Introduction to the case specific ESP-FF retrofit

This thesis is a case study in retrofitting an ESP into a hybrid filter on an existed power plant where the ESP is not meeting the requirements because of a variable fuel mixture of coal and biomass. As the company requested an extra ESP field to meet the environmental requirements, but it was also offered a hybrid filter as it was thought that the resistivity of the emission was causing the problem and that the ESP would have difficulty in capturing the dust.

ESP-FF retrofit construction

The basic modification necessary for the retrofit includes a demolition plan where the internals of one field of the filter are removed, if possible, without damaging the insulation. To start the retrofit, the following steps are to be taken (Figure 35):

Number each step below

1. The internal collecting plates and wires of the ESP field should be removed through the roofs, which would be opened completely. Then, the rain roof, loose reinforced concrete beams and all internals should be removed from the field.
2. Holes are cut in the casing in order to gain access to the casing; the holes should be cut in the sides of the casing. Doors and viewing windows are fitted in the walk in plenum chambers.
3. Tube plates and flow distribution baffles are installed after the access is gained through the roof. The tube plates from which the filter bags are suspended are to provide a barrier between the dirty and clean gas chambers. A set of tubes are to be installed to separate the ESP field from Fabric Filter field a novel feature.
4. Ductwork Modification is necessary to modify the outlet ducting in order to accommodate the clean gas chamber, and allow for space to install cages in the filter bags. The original outlet ducting is to be blanked off.
5. Installation of Pulse Jet Cleaning System is the heart of the plant. It comprises of the blower plant, pulse tanks, diaphragm valve and associated pipework.
5. Installation of ID Fans as discussed earlier, upgraded ID fans are needed to cope with the increased differential pressure across the PJFF-ESP hybrid.
6. The last step to finalize the filter is installation of bags and cages. [20-15]

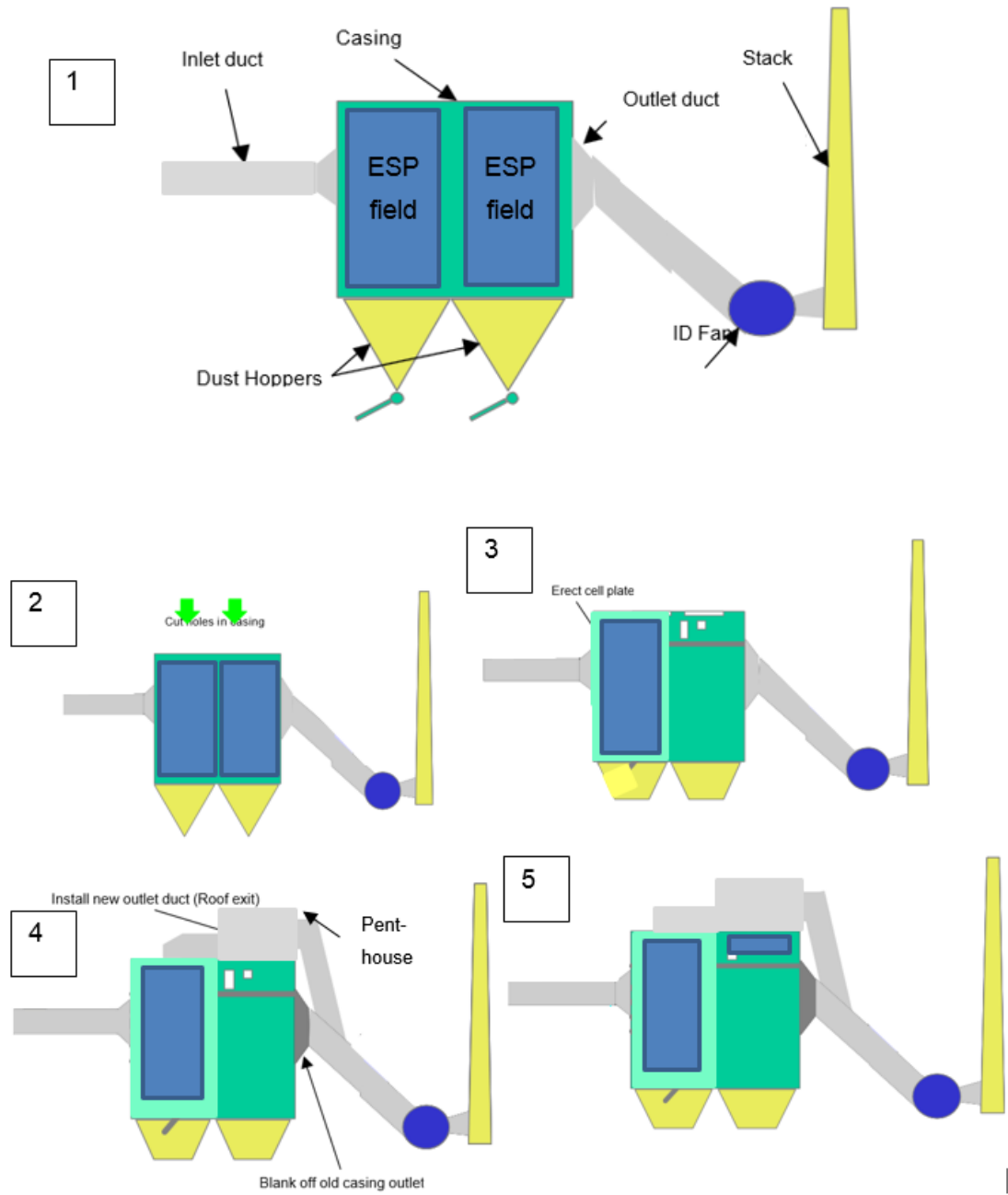

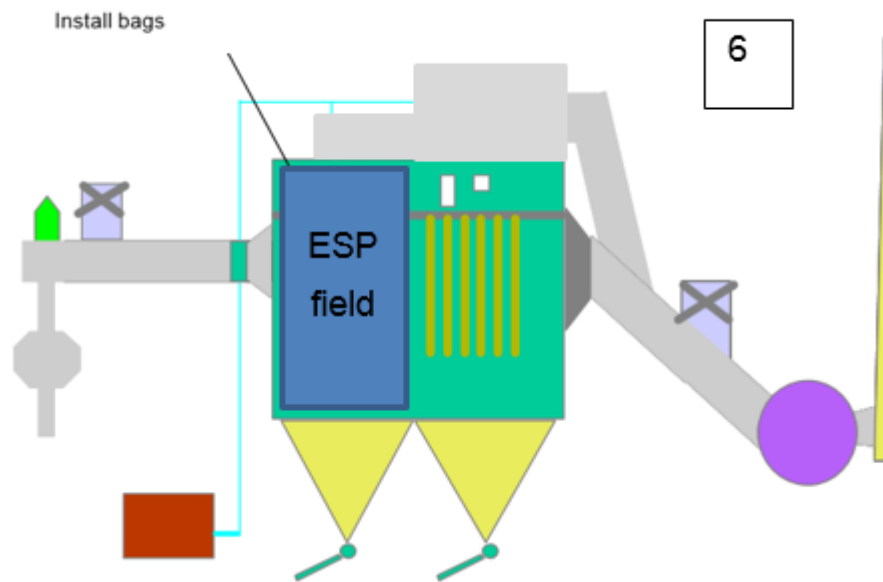

Figure 35. Figure representing the step taken in a conversion of the ESP [20]

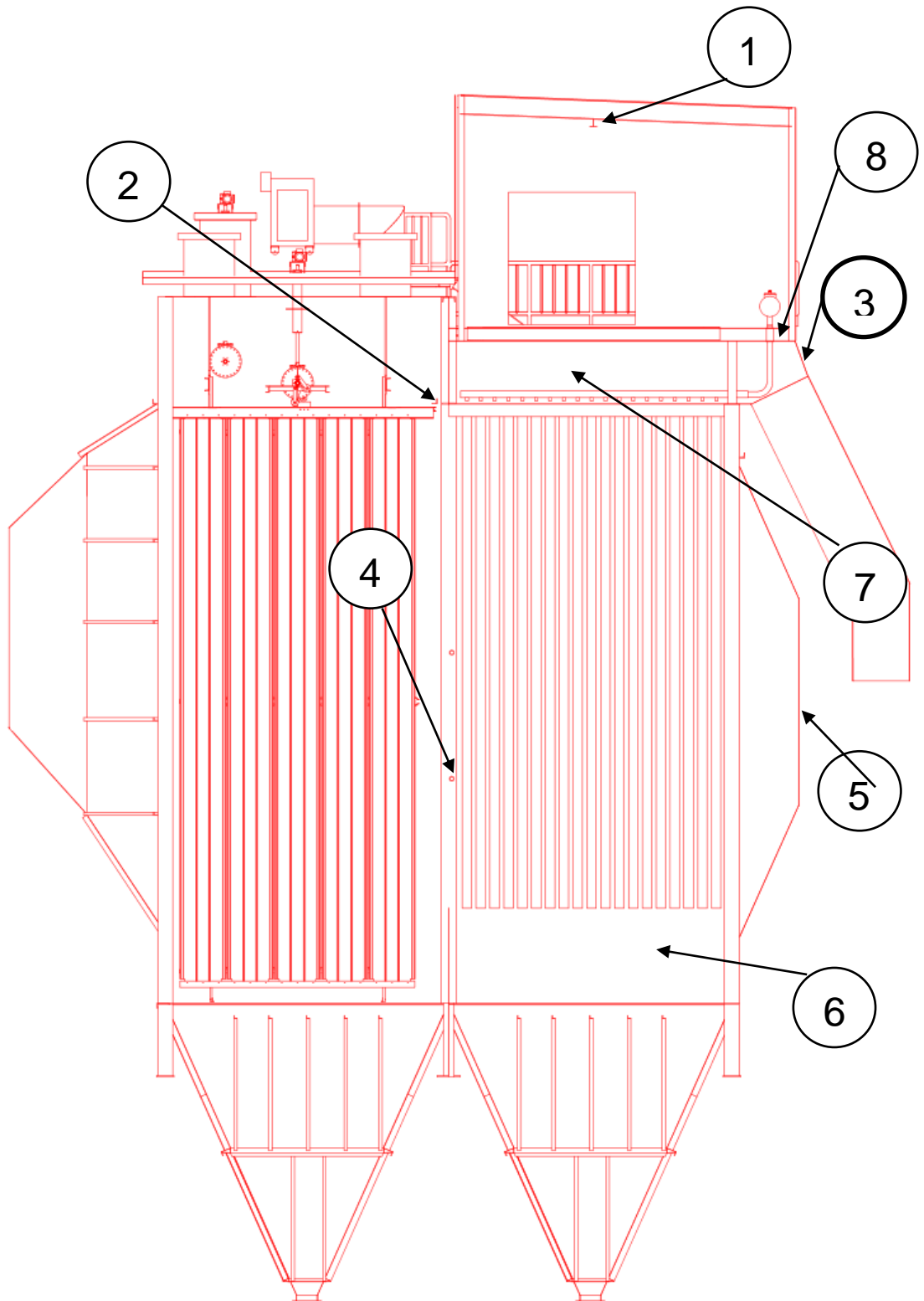

Figure 36. General arrangement drawing of the ESP-PJFF retrofit: side view. side view

The details of the retrofit are as follows (Figure 36):

1: The plates that separate the blowpipes and plate sheets from the room in the pent-house where the header tanks are removed with cables installed in a monorail. This room should have enough space to remove the filter cages. In this case the cages are in three parts so as to easily fit in the room.

2: The fabric bags are at the same level as the collecting plates so as to guarantee a uniform gas flow; this is also the reason why the ESP has been cut in that part and the roof of the ESP has not just been removed. (Some manufacturers do not make this cut and install the bags in the top).

3: The new outlet funnel is on the top as the manner the fabric filter operates in makes it impossible use the former outlet funnel for its original purpose, so some amount of duct work is necessary to connect it to the duct work of the rest of the plant. (This is usually the case with retrofits).

4: Small tubes separate the bags from the plate, and in case of some emergency, there is a design that installs the baffle plate's ore screens between the fabric filter and the ESP. This is usually found in larger retrofits.

5: Blocking the outlet funnel here is cheapest and doesn't negatively affect the performance.

6: Empty space between the bags and the bottom hopper is usually positive the grater it is because it helps larger particles not to re-enter the filter but because of the fact that most of the large particles are already filtered by the ESP; thus, it is so is not really that important.

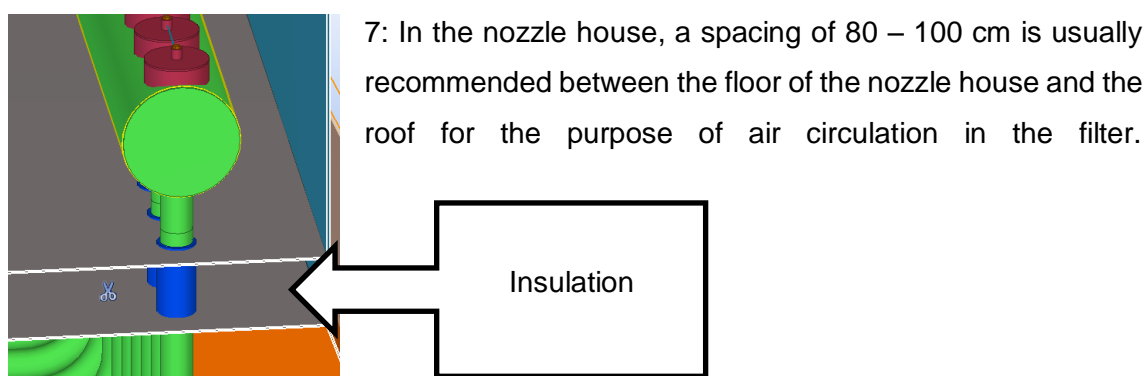

Figure 37. Small detail of the retrofit

8: It is necessary to install insulation between the plenum with the blowpipes and the tube should be separated from the metal with a rubber element so they are not so damaged by the pulse from the valves.

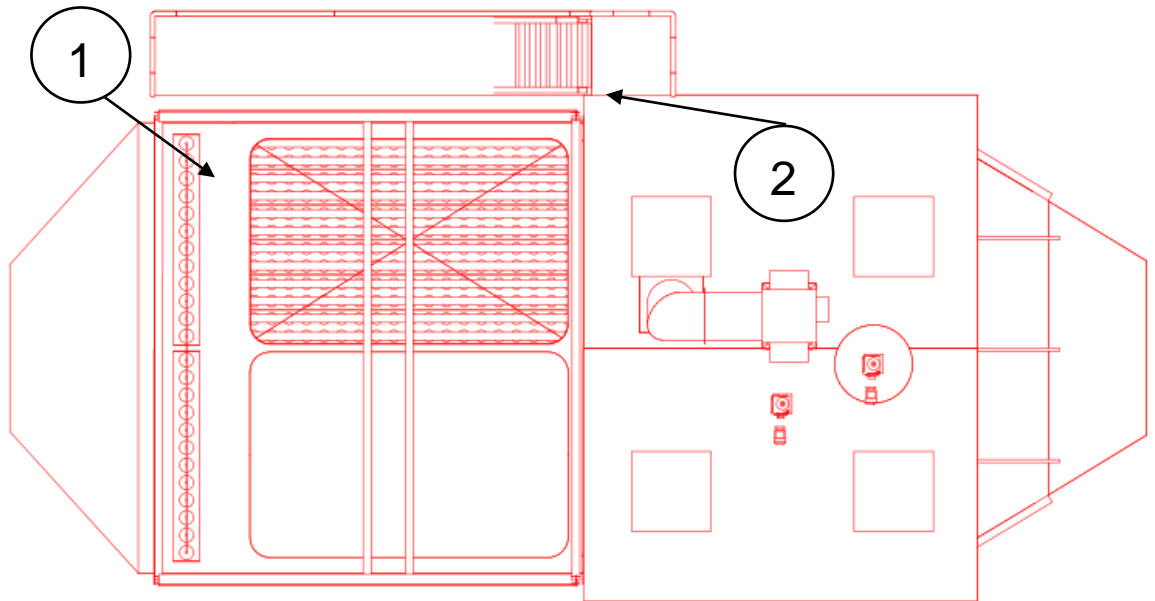

Figure 38. Top view of the filter

Figure 38 shows a top view of the filter. Two parts have been indicated with numbers:  
1: Inside the room, there is enough space for the inspection of header tank and plenty of space for the filter bags. A bigger door is better for easy removal of parts.

2: Access to the fabric filter part of the filter

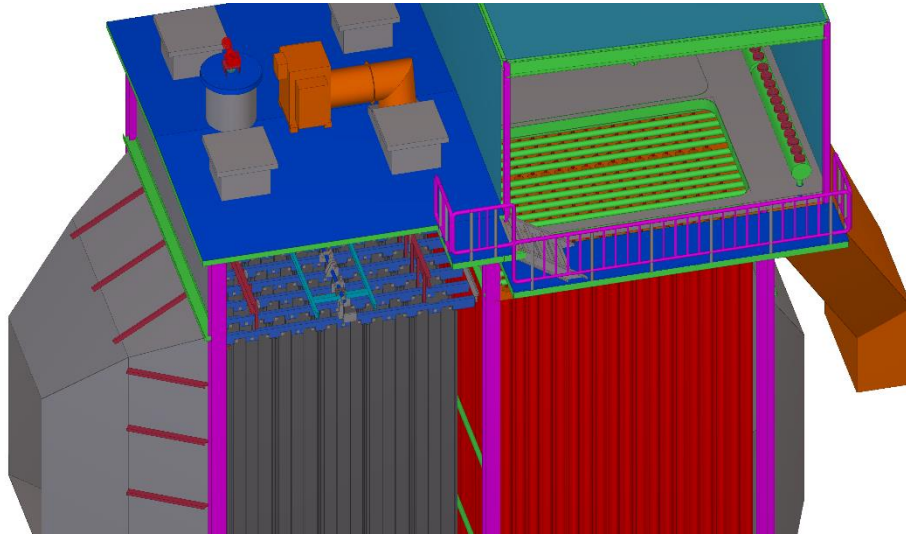

Figure 39. 3D rendition of the retrofit with internal parts visible



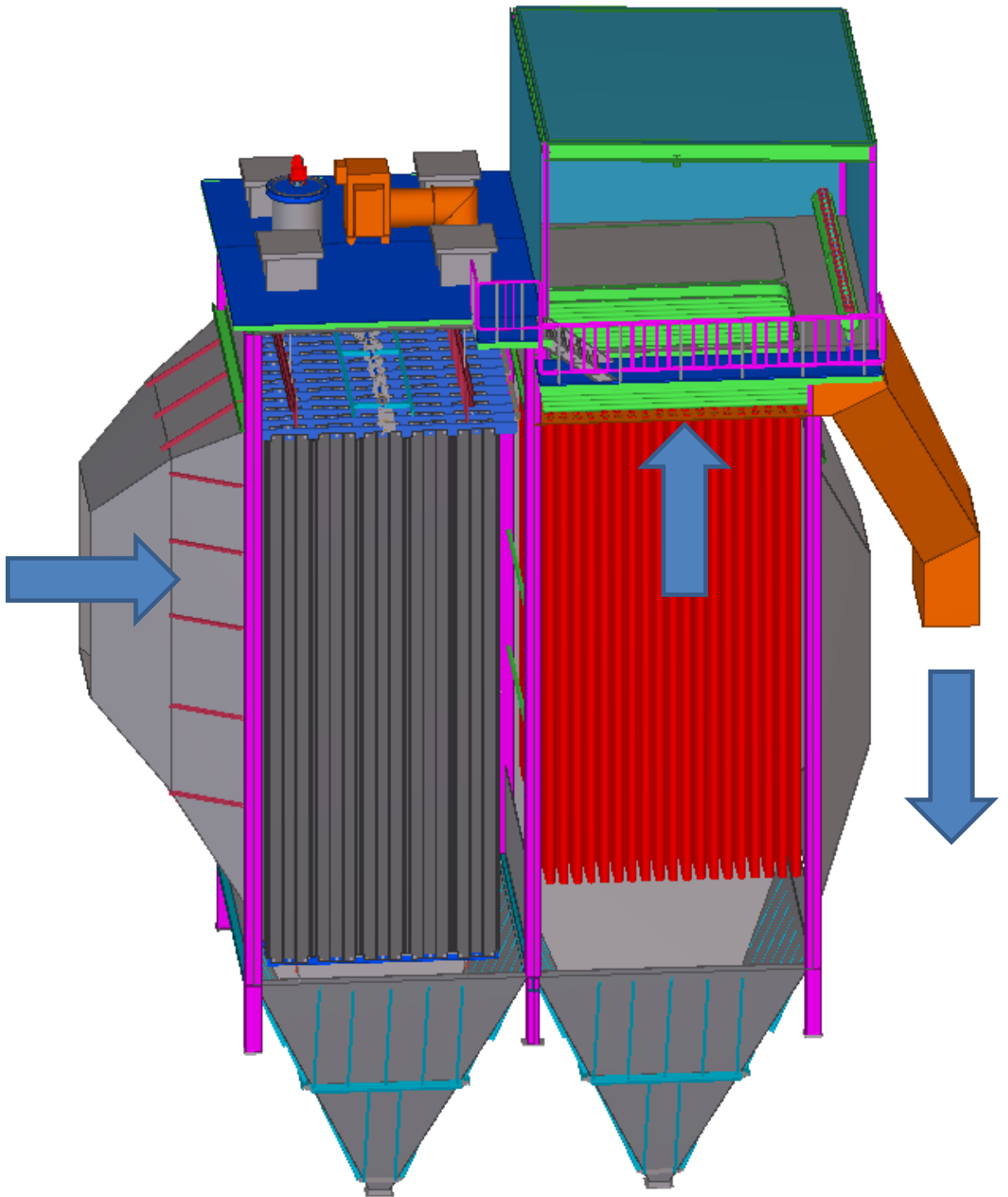

Figure 40. 3D rendition of the filter with arrow indicating the gas flow

## 8 Conclusion

In the end, it is possible to see that the price of retrofitting a fabric filter is lower than that of building a new one but that the operating costs are greater than those of a filter with one field. However, if it is necessary to build a second ESP field, it will be better to operate a fabric filter hybrid.

When making the estimates, there was a problem in accounting for the bag durability as there are not many ways to predict when the bags would actually break or how the amount of pulses would affect their durability. As such further study in bag durability would be warranted so as to create a model.

There is the lack of complexity in a fabric filter that makes the construction of such devices very simple even when the filter is applied to a hybrid design. A mistake in the hybrid design could be relatively easier to fix than in other filters as probably it would not involve building a new structure but making a simple change in the fabric material or in the cage structure.

There is a degree of uncertainty about how well the filter operates. It is possible to predict the minimum operating cost and maximum operating cost but not a true average as the nature of the dust after the fabric filter is unknown because of lack of data. We can make assumptions about it after data is provided by other similar processes, but the result will not be rigorous enough.

As to the ESP, it is easy to arrive at the operating cost as there is a lot of information available about ESPs.

It could be argued that the retrofit would be best in a plant that uses coal as part of the fuel as rather large ESPs are necessary to clean such particles but the cleaning nature of a fabric filter is not affected by the high or low resistivity particles in the same way as that of the ESP.

If the quality of the fuel varies or the type of fuel is changed, a fabric filter retrofit would be ideal.

In cases where emissions contain such particles that it is necessary to build a rather large ESP to take care of the problematic dust, it would be logical to retrofit, especially if the problematic particles are caused because of using different fuels.

In the end, to get to a very low dust emission, it necessary to use a fabric filter as ESP, no matter how large cannot, remove very small particles.

It can be assumed that if the regulation on dust emission control gets tighter, the hybrid option would be more attractive especially for power companies that use mixed fuel that includes coal or similar substances.

## 9 REFERENCES

- 1 Behnke A. European research and legislation with a focus on air pollution [Internet]. 2013 September [cited 2015 January 2015]. Available from: [Http://www.gaef.de/Workshop2013/abstracts/Invited%20Lecture%20VII.pdf](http://www.gaef.de/Workshop2013/abstracts/Invited%20Lecture%20VII.pdf).
- 2 Kärkki J, Flyktman J, Hurskainen M, Helynen M, Sipilä S. Replacing coal with biomass fuels in combined heat and power plants in Finland [Internet]. International Nordic Bio-energy 2011, 2011; 51(1): 199-206 [cited 2014 December 10]. Available from: [Http://www2.vtt.fi/inf/julkaisut/muut/2011/Finland\\_Karki.pdf](http://www2.vtt.fi/inf/julkaisut/muut/2011/Finland_Karki.pdf)
- 3 Turner J, Lawless P, Yamamoto T and Coy D. Electrostatic Precipitators [Internet]. United States Environmental Protection Agency; 1999 [cited 2014 September 10]. Available from: [Http://www.epa.gov/ttnca1/dir1/cs6ch3.pdf](http://www.epa.gov/ttnca1/dir1/cs6ch3.pdf)
- 4 Turner J, Lawless P, Yamamoto T and Coy D. Particle Matter control [internet]. United States Environmental Protection Agency, London: John Murray; 1989. Chapter 1, ESP. [cited 2014 September 10]. Available from: <http://www.epa.gov/ttnca1/dir1/cs6ch1.pdf>
- 5 Zevenhoven R, Kilpinen P. Particulates. Helsinki University of Technology, Faculty of Mechanical Engineering, 2001.
- 6 Ohlström M, Jokiniemi J, Hokkinen J, Makkonen P, Tissari J. Combating Particulate Emissions in Energy Generation and Industry. 1st report. Helsinki: Tekes; 2006.
- 7 Roeck D, Dennis R. Fabric Filter Inspection and Evolution Manual, 1 ed. U.S.A: U.S Environmental Protection Agency; 1984.
- 8 Haney J. Pulse-Jet Baghouse Overview & Common Problems. GE Energy. Report number: 1, 2002.
- 9 Bowden P, Neate M, Currell B and Gerakios M. Fabric filters For Coal Fired Power stations [Internet]. Australia: ICESP; 2006 [cited 2014 September 10]. Available from: [Http://www.isesp.org/ICESP%20X%20PAPERS/PDFS/Paper%206C1.pdf](http://www.isesp.org/ICESP%20X%20PAPERS/PDFS/Paper%206C1.pdf)

10 Bustard C, Cushing K and Chang R. The Potential of pulse jet baghouse for utility boiler part 2: Performance of pulse jet fabric filter pilot plant. Journal of the Air and Waste Management Association 1992; 42(9): 1240-1248.

11 Mathews B, scientific dust collectors, Advantages of cleaning without a venturi in pulse jet baghouse collectors [Internet]. Scientific Alsip, Illinois: Dust Collectors [cited 2015 January 2]. Available from: <http://www.scientificdustcollectors.com/download/current/pdf/sdctechnicalpaper-2.pdf>

12 Mohurle N, Thakare N, Analysis on fabric filtration Material for Pulse Jet Fabrics [Internet]. TIT Bhopal International Journal of Emerging Technology and Advanced Engineering. 2013 June 3; (6): 603-609 [cited 2014 September 5]. Available from: [http://www.ijetae.com/files/Volume3Issue6/IJETAE\\_0613\\_103.pdf](http://www.ijetae.com/files/Volume3Issue6/IJETAE_0613_103.pdf)

13 Unknown, Flue Gas Know How [internet]. Unknown [cited 2014 September 2] Available from: <Http://fluegasknowhow.com>

14 Wang K, Williford C, and Chen W. Air Pollution Control Engineering, 1st ed. Springer: Humana Press; 2004.

15 Hrdlicka T and Swansom W. United State Department of Energy, 2002, Demonstration of full-scale retrofit of the advanced hybrid particulate collector technology. United State Department of Energy; 2002.

16 Miller S, Schelkoph G and Dunham G. Advanced hybrid particulate collector a new concept for air toxics and fine-particle control [internet]. Energy & Environmental Research Center [cited 2015 January 5]. Available from: <http://www.netl.doe.gov/publications/proceedings/98/98ps/ps3b-2.pdf>

17 Tomitatsu K, Kato M, Ueda Y, and Nagata C, International Journal of Plasma Environmental Science & Technology, vol. 8, no. 1, pp. 37-44, 2014, Development of Advanced Electrostatic Fabric Filter

18 Linton R, Ape retrofits and technologies lower emissions and optimize wte production [internet] NAWTEC 2002 [cited 2015 January 15]. Available from: <http://www.seas.columbia.edu/earth/wtert/sofos/nawtec/abstract/nawtec10/nawtec10-1018.pdf>

19 Xiyong Z, Shikai L, Feida Z , A Discussion on the ESP-FF Hybrid Precipitator[internet]. Environmental Science & Technology Gy Co, 2008 [cited 2015 January 10]. Available from: <http://www.isesp.org/ICESP%20XI%20PAPERS/pdfs/472A%20Discussion%20on%20the%20ESP-FF%20Hybrid%20Precipitator.pdf>

20 Steyn F, Baidjurak L and Hansen R, Fabric filter retrofits: an electrostatic precipitator upgrade technology [Internet]. Bateman Howden and Eskom; 2006 [cited 2015 January 3]. Available from: <http://www.isesp.org/ICESP%20X%20PAPERS/PDFS/Paper%209C1.pdf>

21 Ortiz F, Navarrete B,Cañadas L, Salvador L A technical assessment of a particle hybrid collector in a pilot plant [internet]. Chemical Engineering Journal; Available online 20 October 2006, [cited 2014 December 20]. Available from: <http://www.sciencedirect.com/science/article/pii/S138589470600386X>

22 Chen J, Han X. Numerical Simulation on a Hybrid Electrostatic-Bag Precipitator In [internet]: Yan K, editor. Electrostatic Precipitation. 11th International Conference on Electrostatic Precipitation; 2008; Hangzhou. CESP; 2011; XI: 489-492 [cited 2014 September 19]. Available from: <Http://www.isesp.org/ICESP%20XI%20PAPERS/pdfs/489Numerical%20Simulation%20on%20a%20Hybrid%20Electrostatic-Bag%20Precipitator.pdf>

## Appendices

Appendix 1. Option cost estimates.

| Options for bags                  | Kg | Number | Euros/kg | Unit Price | Total Price of material | Transportation | Total Euros |
|-----------------------------------|----|--------|----------|------------|-------------------------|----------------|-------------|
| <b>Bags</b>                       |    |        |          |            |                         |                |             |
| <b>P84+glass fibre (=PI)</b>      |    |        |          |            |                         |                |             |
| <b>PPS+glass</b>                  |    |        |          |            |                         |                |             |
| <b>P84(20)/PTFE(80)+glass</b>     |    |        |          | N/A        |                         |                |             |
| <b><u>PPS+PTFE(scrim)</u></b>     |    |        |          |            |                         |                |             |
| <i>Estimate Prices</i>            |    |        |          |            |                         |                |             |
| <b>Polyester</b>                  |    |        |          |            |                         |                |             |
| <b>Fibber Glass</b>               |    |        |          |            |                         |                |             |
| <b>Ryton</b>                      |    |        |          |            |                         |                |             |
| <b>Nomex</b>                      |    |        |          |            |                         |                |             |
| <b>Teflon</b>                     |    |        |          |            |                         |                |             |
| Tank Pulse Valve                  |    |        |          |            |                         |                |             |
| <b><u>Trimec Tank</u></b>         |    |        |          |            |                         |                |             |
| <b>controller</b>                 |    |        |          |            |                         |                |             |
| <b>Accessories Trimec</b>         |    |        |          |            |                         |                |             |
| <b>Total</b>                      |    |        |          |            |                         |                |             |
| <b>Pentair Tank + Accessories</b> |    |        |          |            |                         |                |             |
| <b>Controller</b>                 |    |        |          |            |                         |                |             |
| <b>Total</b>                      |    |        |          |            |                         |                |             |
| <b>Turbo Tank + accessories</b>   |    |        |          |            |                         |                |             |

Censored

|                           |                 |   |  |       |     |  |  |
|---------------------------|-----------------|---|--|-------|-----|--|--|
| <b>Controller</b>         |                 | 1 |  | 379,5 | 759 |  |  |
| <b>Total</b>              | <i>Censored</i> |   |  |       |     |  |  |
| Cages                     |                 |   |  |       |     |  |  |
| <u>Stainless</u>          |                 |   |  |       |     |  |  |
| <b>Carbon Steel</b>       |                 |   |  |       |     |  |  |
| Steel                     |                 |   |  |       |     |  |  |
| <b>Hole plate</b>         |                 |   |  |       |     |  |  |
| <b>Blow pipes</b>         |                 |   |  |       |     |  |  |
| <b>Main duct - Outlet</b> |                 |   |  |       |     |  |  |
| Compressor                |                 |   |  |       |     |  |  |
| BHF thermal Insulation    |                 |   |  |       |     |  |  |
| Penthouse walls           |                 |   |  |       |     |  |  |
| Penthouse roof            |                 |   |  |       |     |  |  |
|                           |                 |   |  |       |     |  |  |
|                           |                 |   |  |       |     |  |  |



## Appendix 2. Information about the conditions in the fabric filter

|                     |                                       |  |  |
|---------------------|---------------------------------------|--|--|
| Filter in-formation | location                              |  | Finland                                      |
|                     | <b>Application</b>                    |  | Filter for power boiler                      |
|                     | Fuel                                  |  | Peat/wood/coal 50% 30% 20% in energy content |
|                     | Filter system                         |  | Pulse Jet                                    |
|                     | Type of cleaning                      |  | Online                                       |
|                     | Filter area                           | [m <sup>2</sup> ]                      | 3.77   |
|                     | Filter ratio (gross / net)            | [m <sup>3</sup> /m <sup>2</sup> /min ] | 1.6  |
|                     | <b>Bags</b>                           |  | 418 Bags                                     |
|                     | <b>Bag size - diameter</b>            | [mm]                                   | 150  |
|                     | <b>Bag size - length</b>              | [mm]                                   | 8000   |
|                     | <b>Type of fitting</b>                |  | Snap ring                                    |
|                     | <b>Cell plate hole inner diameter</b> | [mm]                                   | 154  |
|                     | <b>Supporting cage</b>                |  | Yes  |
|                     | <b>Thickness of the cell plate</b>    | [mm]                                   | 5  |
|                     | Continuous operation                  |  | Yes  |
|                     | Shut downs / intervals                |  | 1/Year                                       |
|                     | Previously used fabric(s)             |  | N/A  |
|                     | Bag life                              | operating hours                        | 24   |
|                     |                                       | months                                 | 12   |
| GAS                 | Flue gas flow rate                    | [m <sup>3</sup> /s]                    | 54,3   |
|                     | <b>Operating temperature</b>          | [°C]                                   | 161  |
|                     | <b>Peaks</b>                          | [°C]                                   | 175  |

|      |                                   |                       |  |
|------|-----------------------------------|-----------------------|--|
|      | Water dew point                   | [°C]                  | N/A  |
|      | Acid dew point                    | [°C]                  | N/A  |
|      | Lime addition / other additives   | yes / no              | no   |
|      | Kind of adsorption process        |                       |  |
|      | Gas analysis: H <sub>2</sub> O    | [Vol. %]              | 20   |
|      | CO <sub>2</sub>                   | [Vol. %]              | 10,8   |
|      | O <sub>2</sub>                    | [Vol. %]              | 4.4  |
|      | N <sub>2</sub>                    | [Vol. %]              | 20   |
|      | SO <sub>2</sub> / SO <sub>3</sub> | [mg/Nm <sup>3</sup> ] | 470  |
|      | NO / NO <sub>2</sub>              | [mg/Nm <sup>3</sup> ] | 15   |
| DUST | Dust composition                  |                       | Peat/wood/coal 50% 30% 20% in energy content |
|      | <b>Dust load in raw gas</b>       | [mg/Nm <sup>3</sup> ] | 550  |
|      | <b>Dust load in clean gas</b>     | [mg/Nm <sup>3</sup> ] | 10   |